



# Hand Made Places

a division of **broxap**<sup>®</sup>

Playgrounds for Learning & Fun

2018 | 2019

# OUR ICON KEY

To help explain the specifications of each product you'll find these icons.



- Age range



- Minimum use zone



- Critical fall height



- Unit height



- Accessible for wheelchair users



- Bespoke engravings available



FSC

www.fsc.org

FSC® C122338

The mark of responsible forestry

Look for FSC®  
certified products





# CONTENTS

Introduction	04 - 15
Case Studies	16 - 21
Trim Trails	22 - 35
Play Units	36 - 45
Climbing Frames	46 - 53
Traditional Play & Sport	54 - 61
Surfacing	62 - 67
Imaginative Play	68 - 79
Play Sculptures & Totems	80 - 91
Seating	92 - 105
Outdoor Classrooms, Shelters & Shades	106 - 111
Music & Performance	112 - 119
Sand & Water Play	120 - 125
Growing, Planting & Nature	126 - 133
Activity Panels	134 - 141
Inclusive Play	142 - 143
Fencing & Signs	144 - 149
Playground Markings	150 - 155
Timble - Early Years Equipment	156 - 159
Sunshine Gym - Outdoor Fitness Equipment	160 - 171
Gallery	172 - 199
Design your own	200 - 207
The World of Broxap	208 - 209



**ON ALL TIMBER PRODUCTS**



**ON ALL SAFETY SURFACING**

\*20 year timber guarantee against structural failure due to timber rot or insect attack.  
 \*5 year surfacing guarantee against faulty material.  
 Further terms, conditions & qualifications apply. Please see Terms and Conditions.  
 Please visit [www.handmadeplaces.co.uk](http://www.handmadeplaces.co.uk) for details.



# HELLO

Here at Hand Made Places we've seen huge growth since our birth in 2000. Starting life as a one man outfit from a garage we've come a long way, always maintaining our ethos for friendly, personal service and high quality products with a handmade finish.



Our range has grown too, many of our products beginning life as bespoke pieces or 'one offs'. Sometimes an idea may come from a teachers' sketch; their vision of a themed playground, or a drawing that a child has produced as part of a dream playground project. Wherever the vision may come from, our talented designers are constantly seeking out inspiration for ideas to captivate children's imaginations and nurture their social and physical development.

Having firmly established ourselves as a trusted supplier to schools, nurseries and children's centres all over the UK we also work with many town and parish councils as well as national attractions.

Stanton Bridge Primary School,  
Coventry

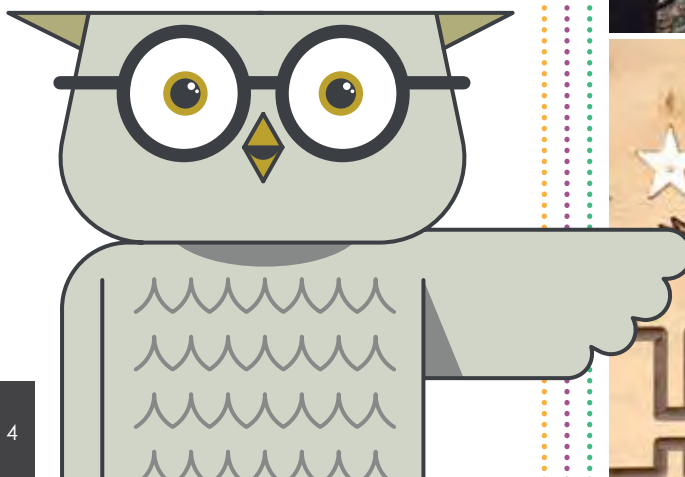

# OUR PROCESS

## CONSULT

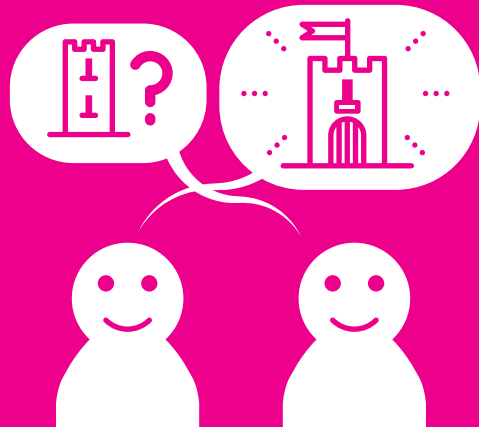

When planning any play area it's best to arrange a site visit. One of our consultants will meet you to discuss your vision and measure the available space. That way you'll get the most accurate proposal and quote to move forwards with.

## DESIGN

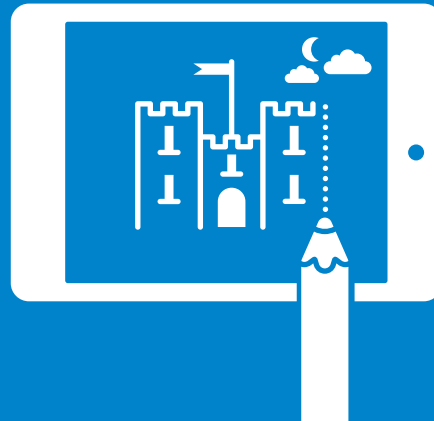

Our creative design department will visualise your ideas, producing a concept presentation for your approval. This could be a full play scheme or a bespoke piece drafted just for you. Once you're happy with the design and quote just place your order.

## MAKE

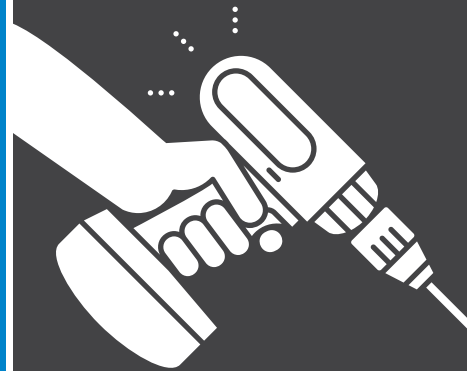

Our UK based workshop is where the real magic happens, with every item crafted in-house. This means that our carpenters, drafts-men and consultants can tailor your project specifically to your requirements.

## ENJOY

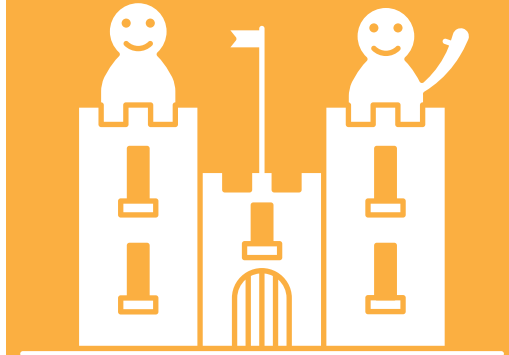

This bit is easy! Just let the children explore their brand new playground, safe in the knowledge that it's as safe and sturdy as possible. Every play item that we produce is manufactured in accordance with BS EN 1176 & BS EN 1177 standards.

Our team of experienced consultants are on hand to offer inspiration and free advice while you're planning your outdoor development. To take advantage of our FREE site visit and design service please contact one of our team to see what we can create for you.

Call us now on: 01420 474 111

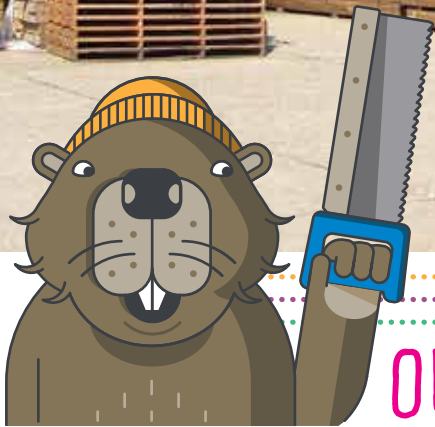

## OUR WORKSHOP

Situated in Bordon, Hampshire on the outskirts of the South Downs National Park is the Hand Made Places workshop. Our home is now a 30,000 sq ft building containing our traditional yet modern facilities and offices. Our talented craftsmen still use traditional construction techniques with all of our products being hand finished to ensure that everything we produce is of the highest quality. Once made, all the parts are sent off for preservative treatment, returned and reassembled to make sure everything still fits together as it should. That way we know that your order reaches you in perfect condition.







## OUR METHOD

### Case Study: Storyteller's Chair

Frequently emulated but never quite the same, our Storyteller's Chair is a classic. Full of magical character it's also easily personalised to have your own message engraved on the back rest. Here's a quick guide explaining how we build it using traditional joinery methods ensuring that it lasts for years to come.

For more info on this product go to page 93



The legs and back rest include our classic engravings.



We always use mortise and tenon joints on our Storyteller's Chair, it's stronger that way.



Glued, clamped and screw fixed the legs are secured to the seat support.



The timber we use is always more than strong enough for the job, the chunky seat support is made to last.



Our chair is set apart by its beautifully angled arm rests giving it a timeless look.



Elegantly machined and built, our chairs are finished by hand every time.



# INSTALLATION OPTIONS

WE CAN OFFER TWO TYPES OF INSTALLATION METHOD...



Root fixed timber posts.



Steel base-plated timber posts.



# OUR INSTALLATION

At Hand Made Places we use installation teams nationwide with hundreds of years of cumulative experience of installing play equipment in schools and other settings. This experience and knowledge is very important to us, because we want all our customers to be provided with a service that fully understands the environments they are working in and show empathy to the day to day running of those sites. That is why all of our clients are part of the Installation process to ensure that they are completely satisfied with the proposed programme of works. All of our team members have successfully been approved by the DBS application.

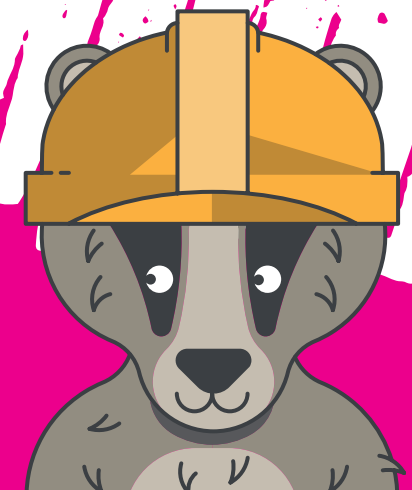

# DESIGN SERVICE

We offer a FREE site visit and design service, so it's easy to get the ball rolling on any type of project. From small Pre-Schools to large new build sites, we can design, manufacture and install a play area to suit.

tel: 01420 474 111



FROM CONCEPT...

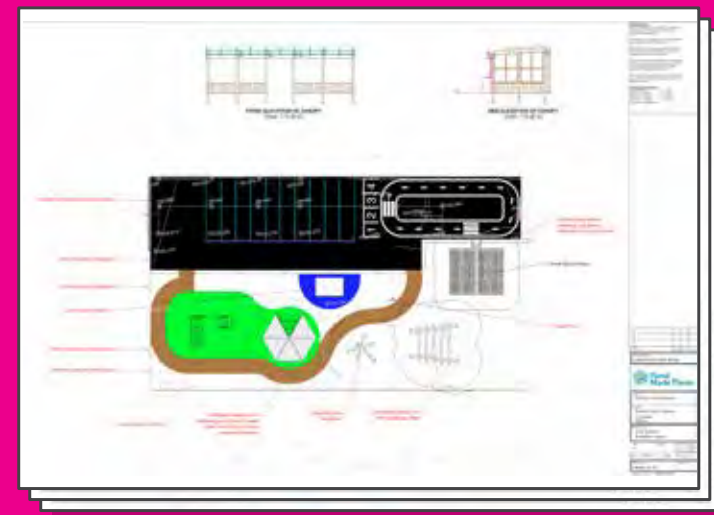

AND PLANNING...

# TO COMPLETION

Windmill Primary School,  
Wellingborough



WE'LL HELP YOU DESIGN  
THE PERFECT PLAY SPACE,  
CONTACT US...  
[info@handmadeplaces.co.uk](mailto:info@handmadeplaces.co.uk)

# BESPOKE DESIGN

Many of our products and designs are developed directly with our customers' ideas in mind. Whether as part of a class project with the input of pupils or simply a wish list, we can accommodate your specific plans.

The most imaginative schemes we've worked on over the years have been a joint effort and there's always great pride and excitement when we create something bespoke. Here are some of the products and spaces we've designed to give you an idea of what we can do for you.

Call us or email to arrange a site visit and get the ball rolling...

tel: 01420 474 111  
info@handmadeplaces.co.uk



Bespoke Pond  
Play Area



Bespoke Polycarbonate Pergola Walkway  
Stebdon Primary School,  
London



Bespoke Heron  
Play Sculpture

Bespoke Fortress Climbing Frame, William Tyndale School, London



Bespoke Shelter with Seating, Alvaston Park, Derby

Bespoke Dinosaur Bench



Bespoke Longboat Outdoor Classroom with bespoke engraved shields, Lyndhurst Primary School, Portsmouth

# BESPOKE ENGRAVINGS

We can engrave many of our products with a design of your own. It could be a school logo, message or a unique illustration created by our design team.

Where you see the pencil icon in our specifications, it indicates that the item can be made with bespoke engravings of your choice.



tel: 01420 474 111  
info@handmadeplaces.co.uk



Bespoke Peter Pan Totem, Houndsfield Primary School, Edmonton, London

Crophorne Charlton First School



Bespoke engraved Totem, Churchfield Primary School

St Teresa's Catholic Primary School





Bespoke engraved Amazing Seating,  
Glebelands Primary School, Leicester



Alvaston Park,  
Derby



West Denton Primary School



Bespoke Longship Shields,  
Lyndhurst Primary School,  
Portsmouth



# CASE STUDY

## The Early Years Foundation Stage

Our Lady of Perpetual Succour Catholic School, Nottingham

The mission statement of Our Lady of Perpetual Catholic School is 'Learn to Love, Love to Learn'. The aim was to create an outdoor area which encouraged learning through play.

With an emphasis on daily outdoor activities, the Nursery required a bespoke Pergola with vinyl rollers, creating a sheltered space to conduct classes. This includes Round Tables and Button Stools as well as a Chalkboard for children to share their creativity and experiences.

The active play zone features our Balksbury, a low level play unit that's ideal for younger children. Surrounding this is "village" themed surfacing with a Roadway and Bound Rubber Mulch track. Combined with Tracing Boards and a Holey Pole Teepee, the children will love to play, as well as learn in their brand new playground.





# CASE STUDY

## Key Stage 1

St Peter's Catholic  
Primary School,  
Hinckley

This playground is a classic Hand Made Places design. By combining a mixture of Imaginative Play items, distinctive Play Sculptures, Musical items and a Trim Trail, the children of St Peter's Primary School now have an engaging space to aid all aspects of their development.

The Willingdon Gazebo offers a place for some playtime chat in the "garden" zone. Leading to it is an entrance archway which, with some red Outdoor Carpet, doubles up as a play stage.

The blue Wet Pour Rubber surrounding the low level Trim Trail creates another zone. Not just a space for physical play, it includes some Congas and a Tracing Board for those who like to be more creative.



# CASE STUDY

## Key Stage 2

Neasdon Primary School,  
Hull

The challenge at Neasdon Primary School was to develop the whole playground so that it could be a purposeful area for both play activities and outdoor learning. Physical development opportunities for children throughout the school was key and there are plenty of those. The log Climbing Frames and Traverse Wall are a big hit, as is the children's gym area.

The huge Broxap shelter we installed with our amazing seating underneath is really popular at lunchtimes with children being able to sit out and socialise whilst they eat their packed lunches. It is also a space which is used regularly for teaching a large class at a time outdoors. The use of the bound rubber mulch surfacing means that the areas can be used all year round without the ground (and children) getting all muddy.



# CASE STUDY

## All Through School

Waverley School,  
Birmingham

This brilliant new school was built as part of the BSF Birmingham scheme and we are excited to have been part of it. Their main principle is learning through diversity, welcoming pupils from 0-19yrs.

Due to the massive spectrum of the school community, there needed to be an opportunity of progression as the pupils grew older; from the children's centre right through to sixth form. Students moving through the key stages of the school had to meet something new, refreshing and challenging in their outdoor play, just as they would academically within their classroom.

From Imaginative Play items to Aerial Zip Slides, Waverley School's 6th Form and Children's Centre certainly has kept its ethos of learning through diversity. The School has since gone on to gain Specialist Humanities Status and has been graded 'Outstanding' by OFSTED!



# CASE STUDY

## Retail & Public

Deepdale Shopping Park,  
Preston

Deepdale Co Ownership Trust required a playground for all ages and abilities, so providing a range of products with a variety of play opportunities was vital.

The focal point of the space is our colourful Action Station III which is packed full of challenging play features including a fireman's pole and perforated steel tunnel.

A Play Boat allows imaginations to flow, reinforcing the ocean theme for younger children to enjoy role play games. This theme is reflected in the Wave Benches too where parents can oversee their little pirates.

A mixture of bespoke Picket and Fortress fence panels create a designated area where children can play safely away from the cars and people shopping at the retail park.



# CASE STUDY

## Bespoke

Beaulieu National Motor Museum, Beaulieu

This world renowned museum is home to many historical vehicles including both Chitty Chitty Bang Bang and the Flying Ford Anglia from the Harry Potter films. Therefore our play unit had to be something special and embody everything that the museum stands for whilst still being fun for children of all ages.

The client requested that the play unit be an exact replica of their open top tour bus. Sticking to this interesting brief we designed an entirely bespoke product, complete with two tiers, a fully functioning cab with moving steering wheel, seating for 'passengers' and even a number plate. The play bus also incorporates all of the distinctive markings and "stops" which can be found on the original bus.





Web Climber

Vertical Scramble Net

Trapeze Rings

Humpback Steps

Stepping Stones

Swing Steps

Canyon Bridge

Traverse Wall

# TRIM TRAILS

# CO-ORDINATE FOCUS ADVENTURE

BOOK YOUR FREE PLAYGROUND CONSULTATION, CALL US ON...

01420 474 111





Dowderry Primary School,  
London

## Balance Beam

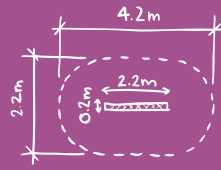

BX/HMP 100001

From **£160**



Bishop Carpenter CE Primary School

## Humpback Steps

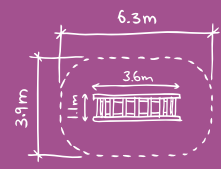

BX/HMP 100033

From **£1,225**



Kew Woods Primary School,  
Southport

## Zig Zag

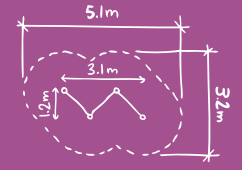

BX/HMP 100031 ( left )  
BX/HMP 100032 ( right )

From **£420**



Townhill Infant School

## Stepping Stone

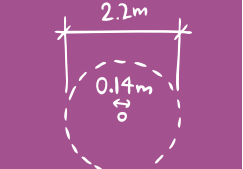

BX/HMP 100017

From **£22**



Downe Manor Primary School,  
Middlesex

### The Reach

3+
 16.2 M2
 0.4m
 1.4m

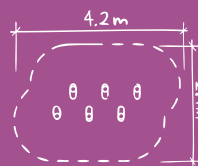

BX/HMP 100090

From **£565**



St Mary's Fields  
Infant School,  
Leicester

### Wobble Board

3+
 13.5 M2
 0.5m
 0.5m

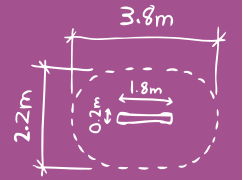

BX/HMP 100029

From **£485**



Woodlands Middle School,  
Bedford

### Web Climber

5+
 26 M2
 2.3m
 2.3m

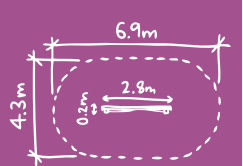

BX/HMP 100910

From **£895**





Bells Farm Primary School,  
Brockworth, Birmingham

## V-Bridge

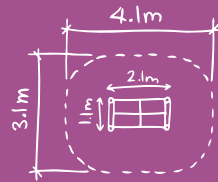

BX/HMP 100027

From **£485**



Queens Retail Park,  
Stafford

## Twist Net

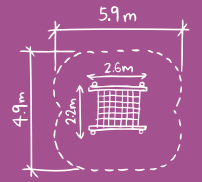

BX/HMP 100088

From **£890**



St John's C of E Primary School,  
Basingstoke

## Up 'n' Over

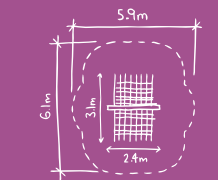

BX/HMP 100026

From **£1,165**



Hill Top CE Primary School,  
Bradford

## Hurdles

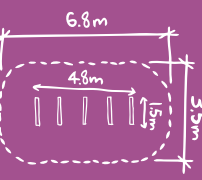

BX/HMP 100009

From **£500**

# TRAPEZE OPTIONS

CHOOSE EITHER  
3, 4, OR 7 TRAPEZE RINGS



Fairfield Road Primary School,  
Droylsden, Manchester

## Trapeze Rings

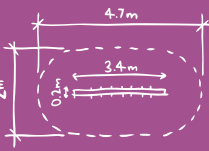

BX/HMP 100022 ( 7 Rings )

Product info, price and photo applies to KS2 option.

From **£575**



St Peter's Catholic  
Primary School

## Vertical Scramble Net

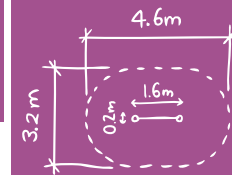

BX/HMP 100028

From **£475**

# TRAVERSE OPTIONS

CHOOSE EITHER  
SINGLE, DOUBLE OR TRIPLE  
TRAVERSE WALL



Thorn Grove Primary School

## Traverse Wall

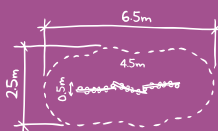

BX/HMP 100024 ( Triple )

Product info, price and photo applies to a 3 panel, KS2 option

From **£1,150**



Holmgate Primary School,  
Chesterfield

## Canyon Bridge

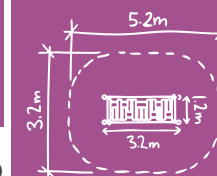

BX/HMP 100085

From **£875**



St John's C of E Primary School,  
Basingstoke

**Rota-Log**

BX/HMP 100099 **From £795**



St Mary's Fields Primary School,  
Leicester

**Clatter Bridge**

BX/HMP 100004 **From £795**



Hillside Primary School

**Duck 'n' Weave**

BX/HMP 100091 **From £545**



Churchfield Primary School

## Cross Over

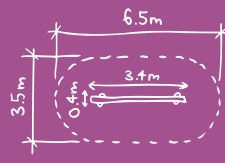

BX/HMP 100006

From **£435**



Woodlands Middle School,  
Bedford

## Rockhold Tunnel

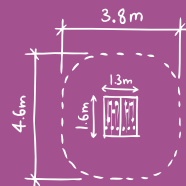

BX/HMP 100013

From **£675**



Hillside Primary School

## Rope Walk

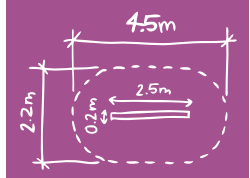

BX/HMP 100014

From **£445**



Queens Retail Park,  
Stafford

## Lumberjack Ladder

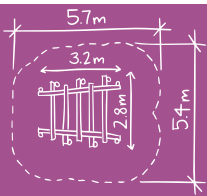

BX/HMP 100087

From **£995**



Park View Primary Academy

## Wobble Bridge

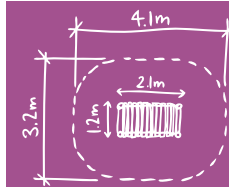

BX/HMP 100030

From **£495**

Woodlands Middle School,  
Bedford



## Swing Steps

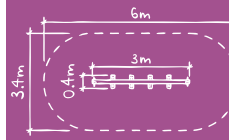

BX/HMP 100019

From **£655**



St Mary & All Saints C Of E Primary School

## Tunnel Climber

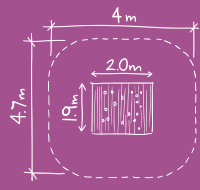

BX/HMP 100089

From **£2,495**



## Balance Weaver

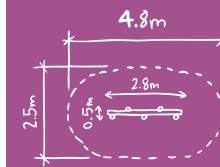

BX/HMP 100002

From **£420**



St Mary & All Saints C Of E Primary School

## Chin Up

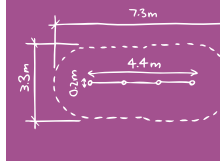

BX/HMP 100003

From **£505**

# TIMBER OPTIONS

FOR ANY TRIM TRAIL

ITEM CHOOSE EITHER...

140mm diameter poles OR

95mm square section



Waverley School,  
Birmingham



## Monkey Bars

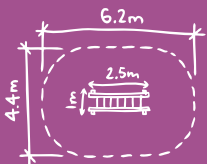

BX/HMP 100911

Product info, price and photo applies to KS2 option.

From **£810**



Sutton Road Primary School

## A - Frame Climber

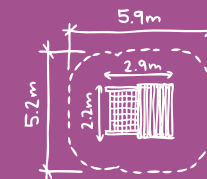

BX/HMP 100912

From **£1,130**



St Teresa's Catholic Primary School

## Jungle Crossing

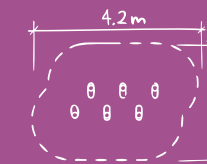

BX/PD 100021

From **£655**



# COMPLETE TRIM TRAILS

COMPLETE AND LINKED TRIM TRAILS,  
PACKAGED INTO HANDY BUNDLES AT  
DISCOUNTED PRICES

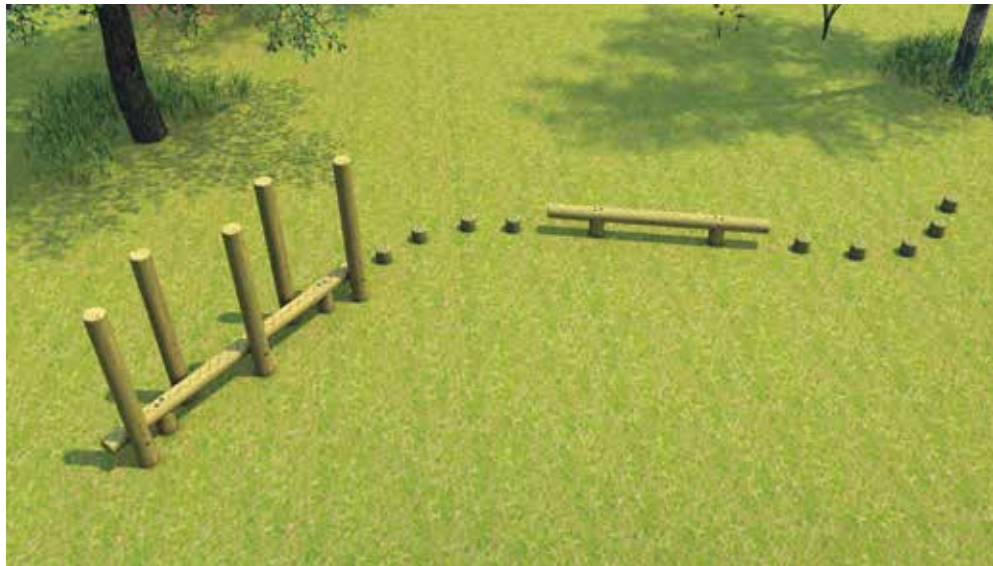
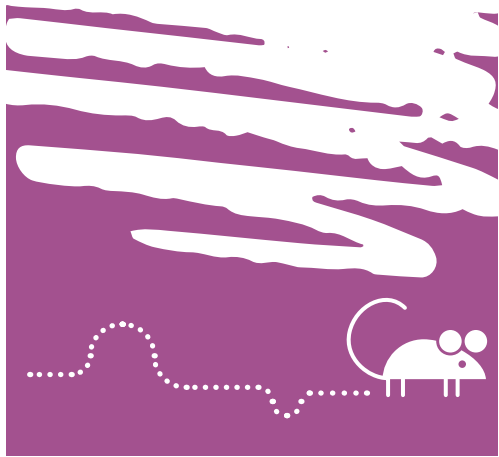

Complete Trim Trail  
**Hawkey Trail**

Stepping Stone x9  
Balance Beam  
Balance Weaver



BX/HMP 100070

From **£715**



Complete Trim Trail  
**Harting Trail**

Balance Beam  
Rope Walk

Swing Steps  
Chin Up



BX/HMP 100076

From **£1,595**



Complete Trim Trail  
**Lindford Trail**

Stepping Stone x8  
Clatter Bridge  
Zig Zag ( right )

Wobble Board  
Stilts



BX/HMP 100075

From **£2,095**

NEW!



Linked Trim Trail

## Selbourne Trail

Balance Beam  
Trapeze Rings ( 7 )

Double Ropes  
Wobble Bridge

Rope Walk  
Balance Beam



BX/HMP 100100

From **£1,995**

NEW!



Linked Trim Trail

## Fernhurst Trail

Balance Beam  
V-Bridge

Jungle Crossing  
Wobble Bridge

Swing Steps  
Balance Weaver



BX/HMP 100101

From **£2,995**

Let us help you  
design the perfect  
play space,  
contact us...



[info@handmadeplaces.co.uk](mailto:info@handmadeplaces.co.uk)



Chute

Balksbury

PLAY UNITS

CLAMBER  
CLIMB  
DISCOVER

WANT EXPERT HELP WITH PLANNING  
YOUR SPACE? CALL US ON...

01420 474 111

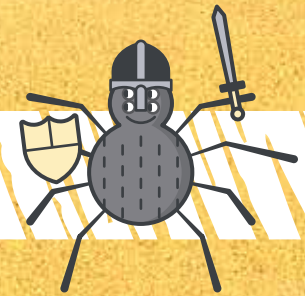



Our Lady Catholic School,  
Nottingham

## Balksbury

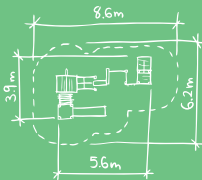

BX/HMP 050001

From **£3,995**



Townhill Infants School,  
Southampton

## Townhill

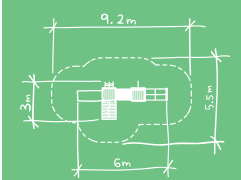

BX/HMP 050018

From **£3,450**



Cranford House Independent School,  
Moulsoford,  
Wallingford

## Glade

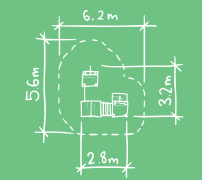

BX/HMP 050006

From **£2,495**



St Mary's Fields Infant School,  
Leicester

## Northam

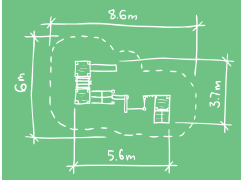

BX/HMP 050009

From **£3,545**



0.6m platform height available

### Toddler's Tower

BX/PD 050008

Product info, price & photo applies to a 0.9m fall height option

From **£2,995**

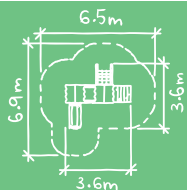

The Village School, London

### Mount Ridge

BX/HMP 250035

From **£3,990**

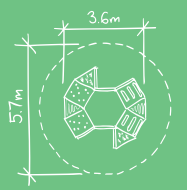

Rowan Preparatory School

### Sunflower

BX/HMP 050011

From **£3,545**

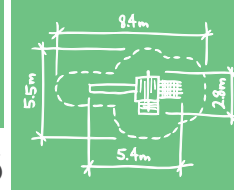



Rudheath Primary Academy

**Crofton**

3+ 32 M2 >0.7m 1.6m FSC

BX/HMP 050005 From **£1,695**



Hanley St Luke's C of E Aided Primary School, Stoke-on-Trent

**Littlegarth**

5+ 41 M2 >1.3m 2.9m FSC

BX/HMP 050008 From **£2,750**



**Bloxham**

3+ 23.3 M2 >0.9m 1.7m FSC

BX/HMP 050016 From **£1,595**



Stokewood Road Children's Centre, Bournemouth

**Kinglade**

5+ 35 M2 >1m 3.1m FSC

BX/HMP 050007 From **£3,495**



### Action Station I

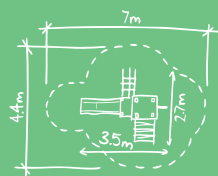

BX/HMP 050901

From **£2,935**

Stoke St Michael,  
Somerset



### Action Station II

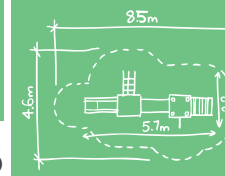

BX/HMP 050902

From **£4,065**

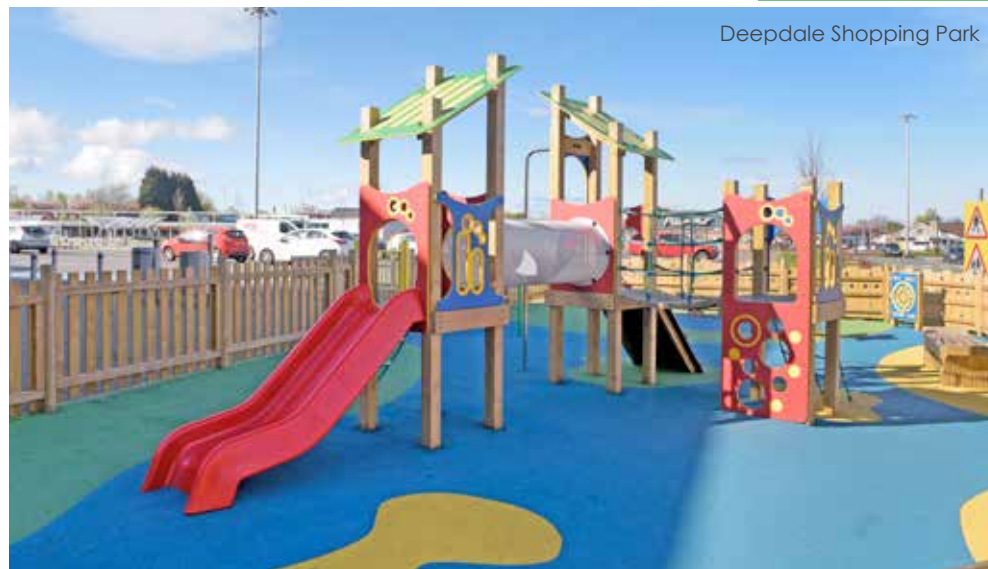

Deepdale Shopping Park

### Action Station III

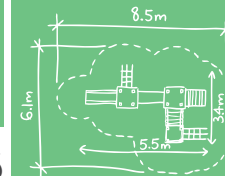

BX/HMP 050903

From **£5,585**





Penn Wood Primary  
School & Nursery School,

The Chute is a really dynamic Play Unit. With doorways and windows, it's great for a game of hide and seek. Another game to play is King of the castle, making use of the differing heights and perspectives of the platforms.

## Chute

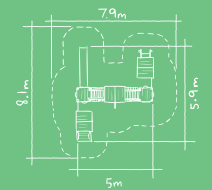

BX/HMP 050019

From **£5,995**



# Shirley

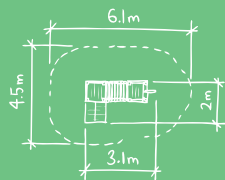

BX/HMP 050010

From **£1,750**



# Chichester

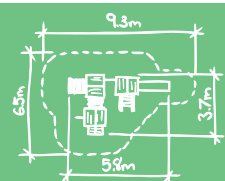

BX/HMP 050003

From **£4,295**



Cullompton Pre School,  
Devon

# Milton

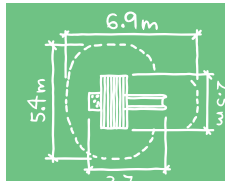

BX/HMP 050020

From **£2,750**



Great for older children, the Manor is stuffed with challenging features. There's plenty for upper body strength development as well as role and social play opportunities.

## Manor

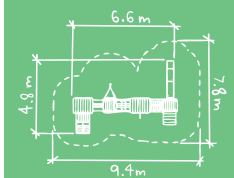

BX/HMP 050015

From **£6,500**



# Country Kingdom

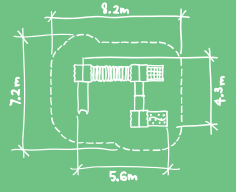

BX/PD 150005

From **£6,050**



# Henry IV

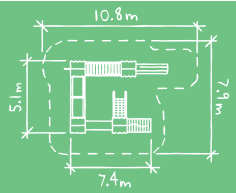

BX/PD 150009

From **£7,950**

Windmill Primary School,  
Wellingborough



# Tufnell

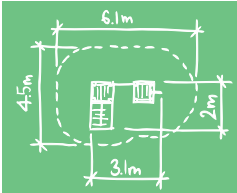

BX/HMP 050012

From **£1,845**

NEW!



Many of our products start life as an idea or request from schools and clients, such as our Woodland Escape Play Unit. Why not take a look at our bespoke design section on page 12 and see what we can create for you.

## Woodland Escape

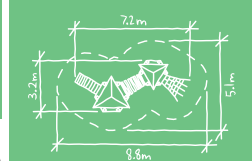

BX/HMP 050021

From **£8,925**



Ashbury

Amazon Rope Climber

Beddington

Hawk's Nest

CLIMBING  
FRAMES

BALANCE  
SCRAMBLE  
EXPLORE

LET US HELP YOU DESIGN THE PERFECT  
PLAY SPACE - CALL US ON...

01420 474 111





William Hildyard C of E Primary School

### Heron's Nest

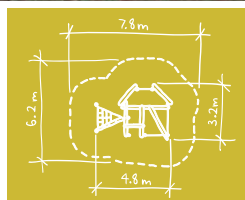

BX/HMP 150021

From **£1,750**



Old Dalby C of E Primary School,  
Melton Mowbray

### Wren's Nest

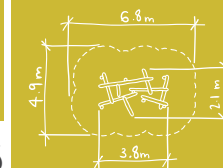

BX/HMP 150020

From **£1,195**



Appleby Magna Recreation Ground

### Hawk's Nest

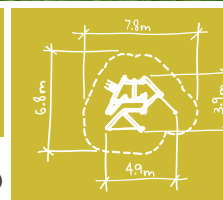

BX/HMP 150022

From **£2,215**



Downe Manor Primary School,  
Middlesex

# Aldwickbury

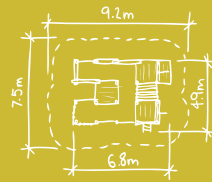

BX/HMP 150026

From **£4,485**



Lancaster West Estate  
London

# Meadows

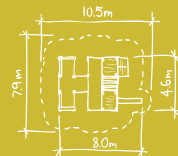

BX/HMP 150023

From **£5,995**



Neasdon Primary School,  
Hull

# Andover

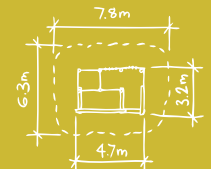

BX/HMP 150004

From **£2,775**





Broadway Infant School,  
Yate

Obstacles like wobbly nets and scattered poles have an unpredictable nature which, when mastered, gives children a sense of achievement. By taking risks they challenge themselves whilst being active in a non-prescriptive environment. Turn the page for our range of Net Climbers.

## Bird's Nest



BX/HMP 150017

From **£1,595**

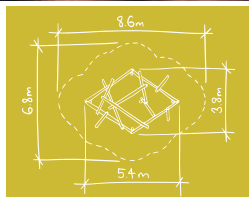



Thorn Grove Primary School

# Congo Rope Climber

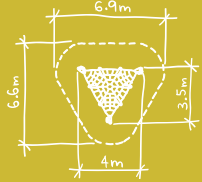

BX/HMP 150023

From **£1,795**



Our Lady Catholic School,  
Nottingham

# Pinner

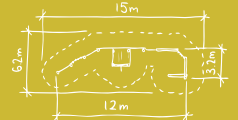

BX/HMP 150013

From **£4,200**



Hillside Primary School

# Knowle

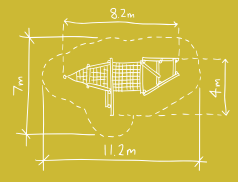

BX/HMP 150019

From **£2,995**



Our rope work is made in-house to ensure that everything we produce is of the highest quality. Have a look at page 5-8 to find out more about our workshop and manufacturing process.

## Amazon Rope Climber

5+ 66.7 M2 2.4m 2.4m FSC

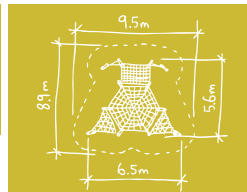

BX/HMP 100050

From **£5,150**

Waverley School,  
Birmingham



## Ashbury

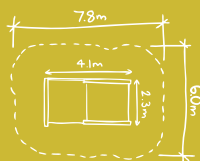

BX/HMP 150902

From **£1,995**



St Hilda's C of E Primary School,  
Manchester

## Mini Ashbury

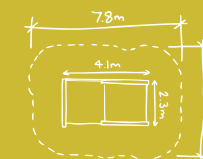

BX/HMP 150024

From **£1,695**



Houndsfield Primary School,  
Edmonton, London

## Beddington

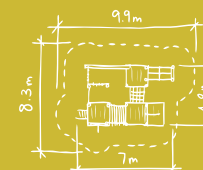

BX/HMP 150005

From **£5,450**



Can't see what you want?  
The best way to find out which Climbing Frame suits your project is  
to request a FREE consultation. Email us with your requirements...

[info@handmadeplaces.co.uk](mailto:info@handmadeplaces.co.uk)

**Ripley**

5+ 84.4 M2 1.6m 2.7m FSC

BX/HMP 150014

From **£7,995**

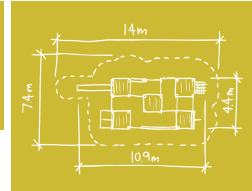



Aerial Zip Slide

Double Flat Swing

Nest Swing

Embankment Slide

TRADITIONAL  
PLAY & SPORTS

SWING  
SPRING  
SLIDE

NOT QUITE SURE WHAT WILL WORK? CALL US  
FOR A FREE CONSULTATION NOW ON...

01420 474 111

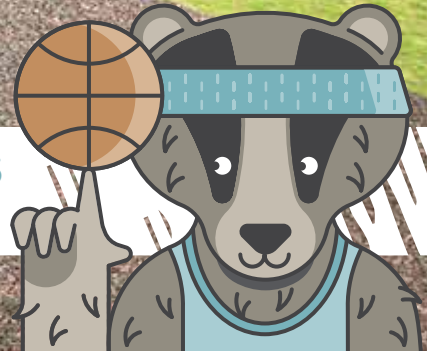

# EMBANKMENT OPTIONS

MAKING THE MOST OF AN AWKWARD GRASS BANK CAN BE TRICKY, SO EVERY PROJECT NEEDS TO BE TREATED INDIVIDUALLY.

BOOK A SITE VISIT AND WE CAN MAKE A START...  
info@handmadeplaces.co.uk



Waverley School,  
Birmingham

## Embankment Slide



BX/PD 100074

From **£POA**



St Ives Junior School,  
Trenwith, St Ives, Cornwall

## Embankment Net

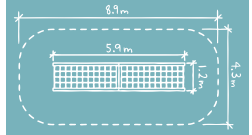

BX/PD 100013

Product info, price & photo applies to a 6m option.

**£1,665**



Djanogly Northgate  
Academy

## Embankment Ramp

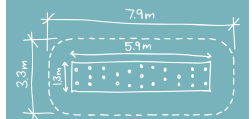

BX/PD 100014

Product info, price & photo applies to a 6m option.

**£1,375**

Great Easton  
Recreation Ground,  
Leicestershire



## Double Cradle Swing

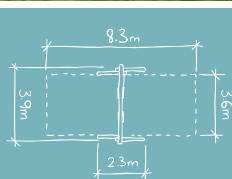

BX/HMP 100035

From **£1,125**

Great Easton  
Recreation Ground,  
Leicestershire



## Double Flat Swing

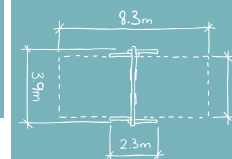

BX/HMP 100036

From **£985**



Lodsworth Recreation Ground

## Double Bay Swing

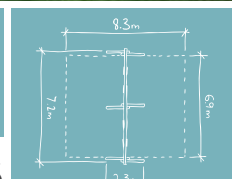

BX/HMP 100034

From **£1,865**



Great Easton  
Recreation Ground,  
Leicestershire



## Nest Swing

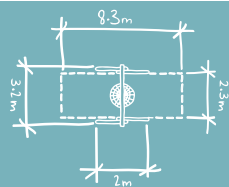

BX/HMP 100094

From **£1,595**

Great Easton  
Recreation Ground,  
Leicestershire



## Single Cradle Swing

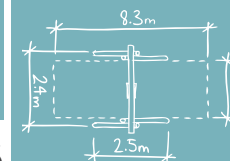

BX/HMP 100044

From **£1,025**



Lodsworth Recreation Ground

## Single Flat Swing

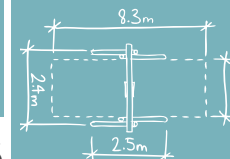

BX/HMP 100047

From **£945**

Lodsworth Recreation Ground



## Aerial Zip Slide

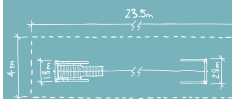

BX/HMP 100048

Product info, price & photo applies to a 20m option.

From **£4,450**

Broadway Infant School, Yate



## Combi Goal



BX/HMP 100038

From **£1,345**

Thorn School For The Deaf, Bradford



## Ball Wall

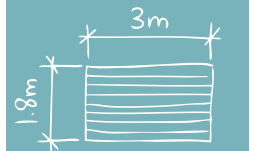

BX/HMP 100040 - Single Sided  
BX/HMP 100039 - Double Sided

From **£685**



## Timber Tunnel

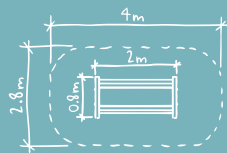

BX/HMP 100046

From **£1,195**



Froyle Parish Council

## See - Saw

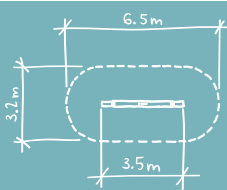

BX/PD 100040

From **£1,295**



Broadway Infant School,  
Yate

## Fireball



BX/PD 100016

From **£785**



### Ladybird Springy

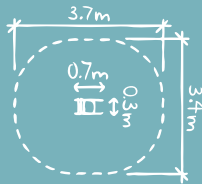

BX/HMP 100098

From **£595**



Lancaster West Estate Play Area, London

### Chicken Springy

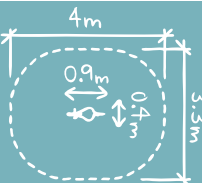

BX/PD 300004

From **£595**



Bickleigh Down Primary School, Woolwell, Plymouth

### Springy Disc

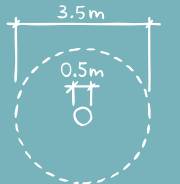

BX/PD 300016

From **£350**



### Whale Springy

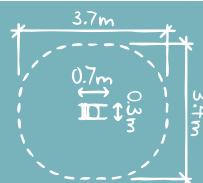

BX/PD 300018

From **£595**



Christow Playing Fields  
Christow, Devon

## Cow Springy

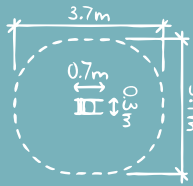

BX/PD 300005

From **£595**



Miniature Pony Centre, Moreton,  
Hampstead, Devon

## Tractor Springy

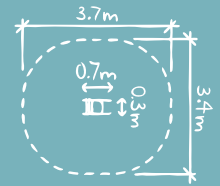

BX/PD 300017

From **£620**



## Bee Springy

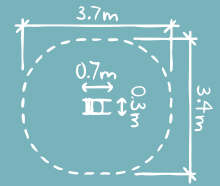

BX/HMP 100097

From **£595**



Hard Wood Chips

Grass Saver Matting

Bound Rubber Mulch

Wet Pour Rubber

Artificial Grass



# SURFACING

# HOP BOUNCE TUMBLE

BOOK YOUR FREE PLAYGROUND CONSULTATION, CALL US ON...

01420 474 111

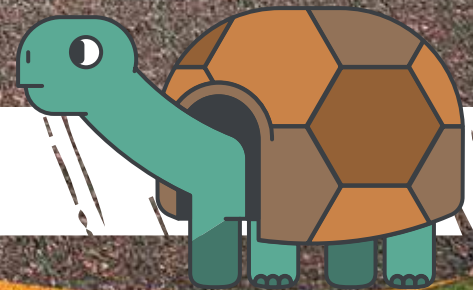

WET POUR RUBBER SURFACING IS SO VERSATILE. INCLUDE ALMOST ANY THEME AND DESIGN TO YOUR PLAY AREA.

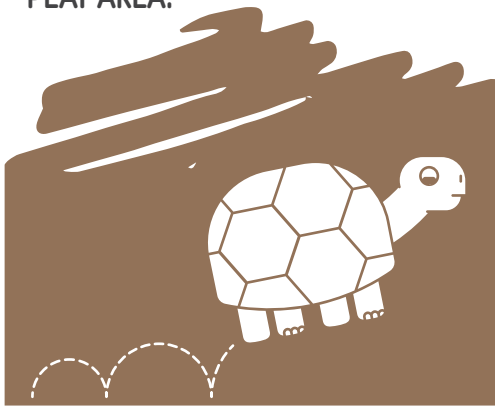

Rowan Preparatory School



Maple Court Academy



Townhill Infant School



Ysgol Y Gogarth, Llandudno



## Wet Pour Surfacing



From £POA

BX/HMP 600030-S



NO MORE MUD WITH THIS REALISTIC OPTION. ADD SHOCK PADS FOR ADDITIONAL SAFETY.

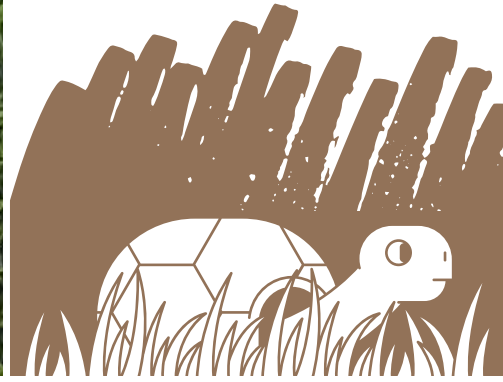

Downe Manor Primary School, Middlesex

# Artificial Grass



From £POA

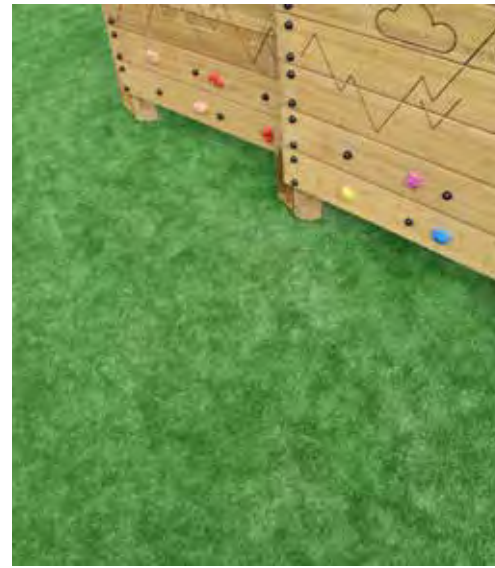

Thorn Grove Primary School





Our Lady of Perpetual Succour Catholic School, Nottingham

# Bound Rubber Mulch



BX/HMP 600045

From **EPOA**

PERFECT IN NATURALISTIC SURROUNDINGS, BOUND RUBBER MULCH IS IDEAL AROUND TREES.

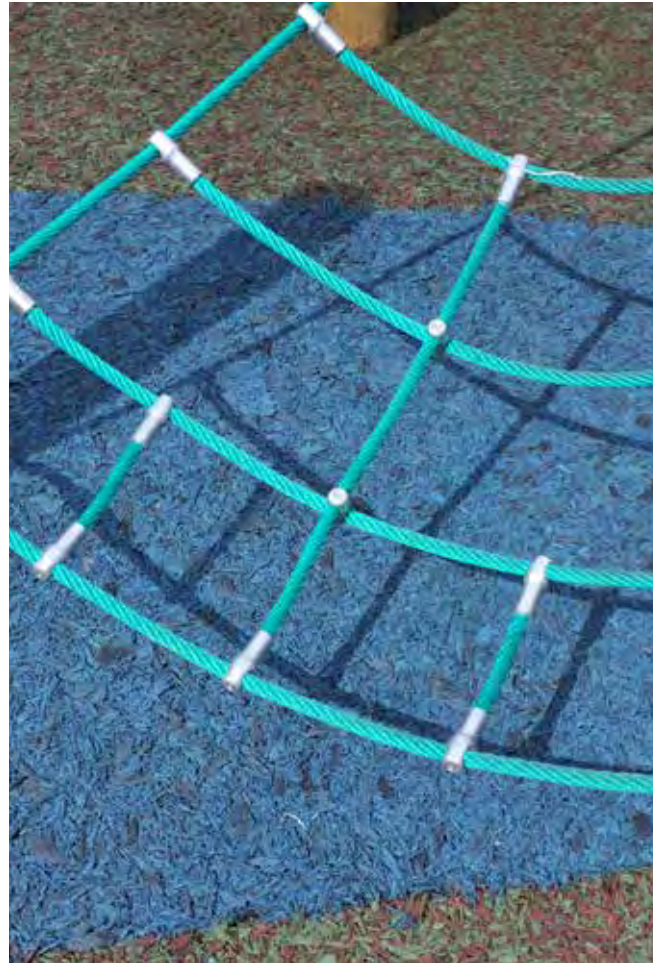

THIS LOW COST SAFETY SURFACE WILL ALLOW GRASS TO GROW THROUGH, CREATING A NATURAL PLAY SPACE.

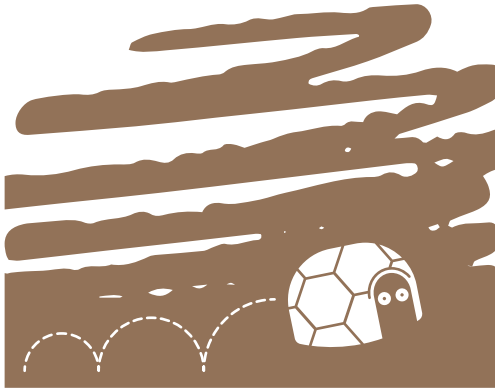

Ysgol Y Gogarth, Llandudno



Cadland Children's Centre

### Saver Grass Matting



NOT JUST A BUDGET OPTION,  
HARDWOOD CHIPS ARE OUR  
MOST ECO FRIENDLY  
SOLUTION TOO.



Stoke St Michael,  
Somerset



## Hardwood Chips



From **£POA**

BX/HMP 600022

Stoke St Michael,  
Somerset

SURFACING

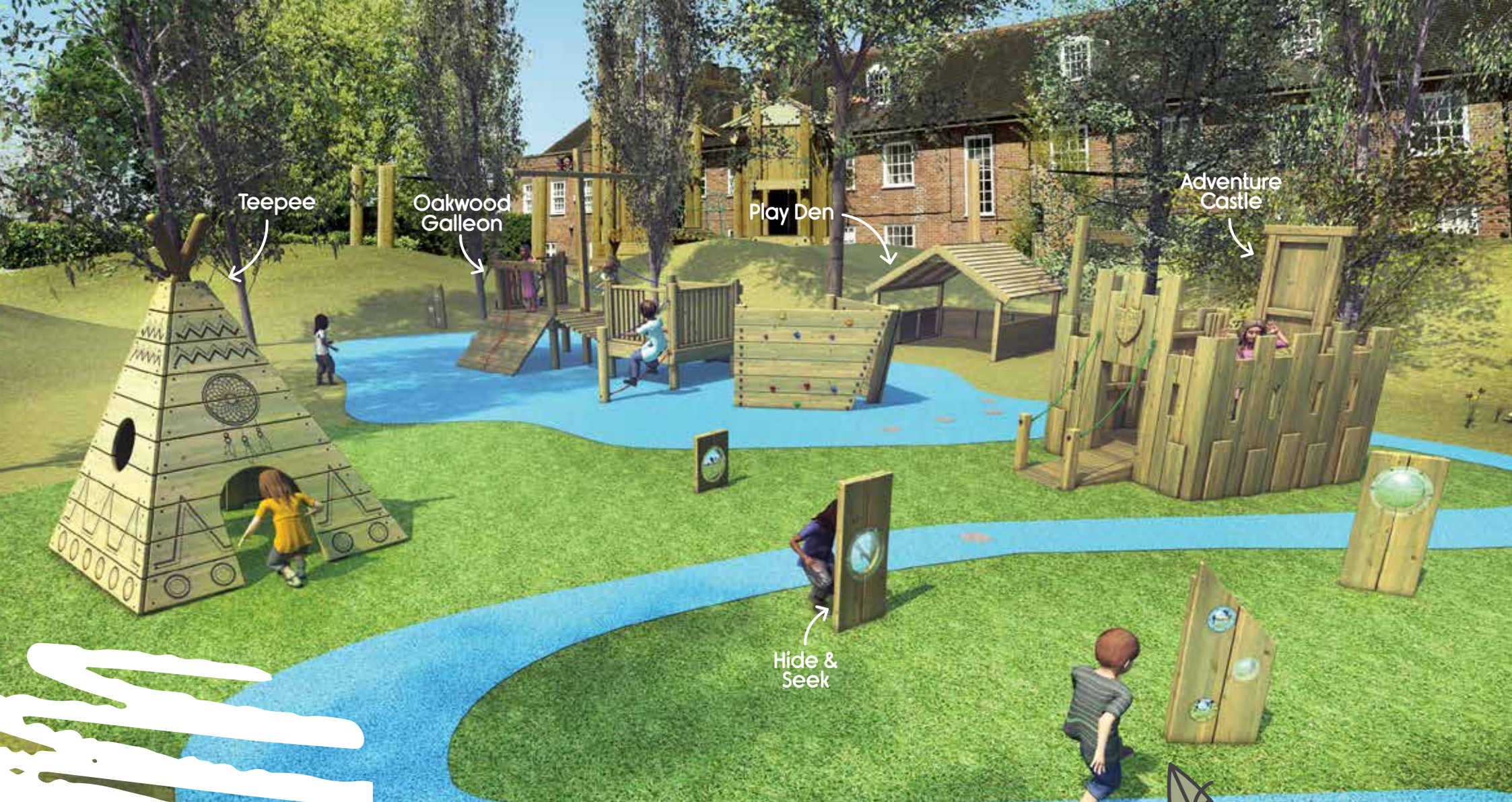

Teepee

Oakwood Galleon

Play Den

Adventure Castle

Hide & Seek

IMAGINATIVE  
PLAY

IMAGINE  
SHARE  
SPARK

WANT EXPERT HELP WITH PLANNING  
YOUR SPACE? CALL US ON...

01420 474 111





Four Oaks Primary School

# Teepee

2+
 23.1 M<sup>2</sup>
 2.7m

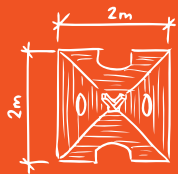

BX/HMP 250034

From **£1,695**



Free standing option also available

# Lighthouse

2+
 21.3 M<sup>2</sup>
 0.5m
 2.1m

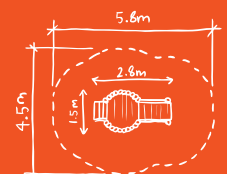

BX/HMP 250011

From **£2,080**



Maple Court Academy

## Wave Bridge

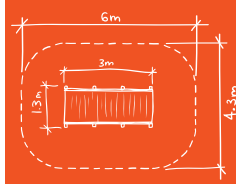

BX/HMP 800010

From **£995**



Downderry Primary School, London

## Arch Bridge

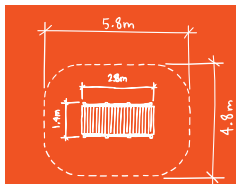

BX/HMP 250002

From **£1,100**



Eastfield Nursery School & Children's Centre, Wolverhampton

## Pirates and Islands

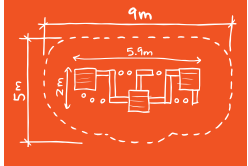

BX/HMP 250014

From **£ 1,650**



Norman Laud Centre

## Mackenzie Bridge

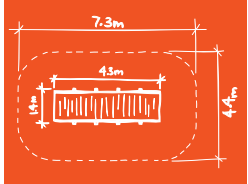

BX/HMP 800011

From **£1,080**



White Rock Primary School,  
Paignton

## Vanilla Playhouse

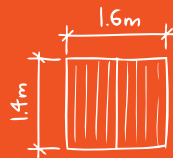

BX/HMP 250902

From **£999**



Zetland Primary School,  
Redcar

## Queen of the Castle

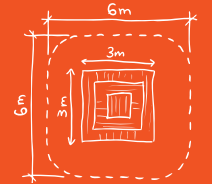

BX/HMP 250009

From **£995**



Thorn Grove Primary School,  
Cheadle

## Mini Fort

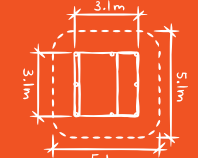

BX/HMP 250051

From **£2,850**



Cleethorpes

## Play Train

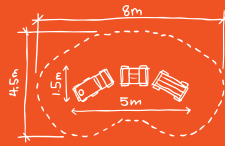

BX/HMP 250041

From **£2,350**



Four Oaks Primary School

## Play Den

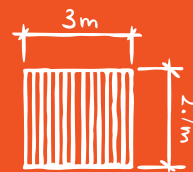

BX/HMP 250052

From **£1,750**



Shireland Hall Primary School,  
Birmingham

## Petrol Pump



BX/HMP 250012

From **£270**

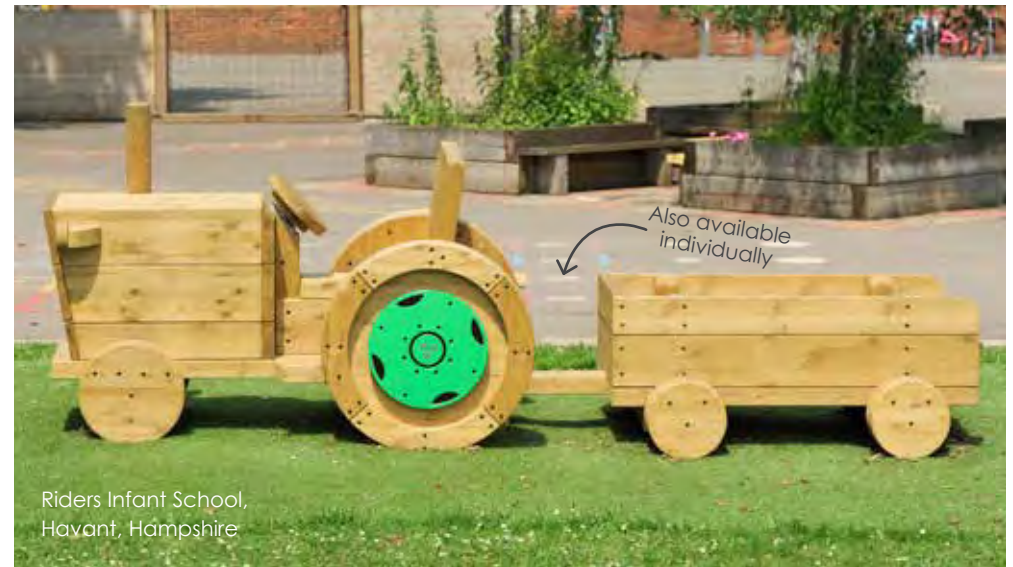

Riders Infant School,  
Havant, Hampshire

## Tractor & Trailer

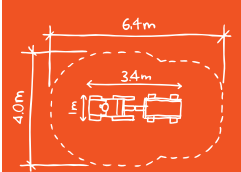

BX/HMP 250033

From **£2,570**





Crophorne With Charlton C Of E First School

## Hide & Seek

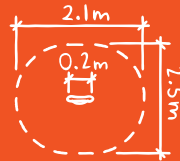

BX/HMP 750014

From **£995**



## Vanilla Workshop

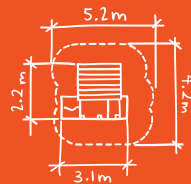

BX/HMP 250043

From **£2,170**

Woodhouse West Primary School,  
Sheffield



## Holey Poles

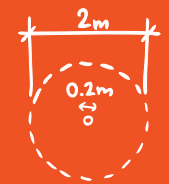

BX/HMP 250037

Set of four from **£295**



Maple Court Academy

## Holey Pole Teepee

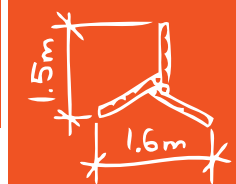

BX/HMP 250038

From **£225**

Our Lady Of Lourdes Catholic  
Primary School,  
Southport



## Play Boat

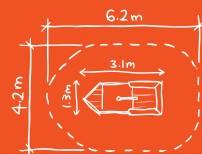

BX/HMP 250016

From **£1,210**



## Play Plane

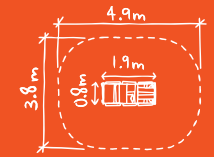

BX/HMP 250042

From **£1,850**



## Oakwood Galleon

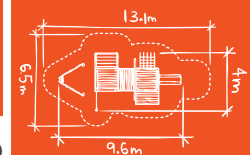

BX/HMP 250044

From **£4,725**



If you're looking to create a fun theme in your playground, try pairing our Nautilus up with an Octopus or Shark Play Sculpture. Turn to page 84 to see them...

## The Nautilus



BX/HMP 150016

From **£6,995**

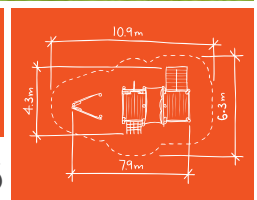



Lingey House Primary School,  
Gateshead

## Micro World Table

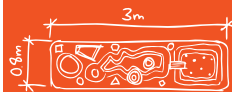

BX/HMP 250003

From **£1,990**



Rossmere Primary School

## Mini Micro World Table



From **£895**



**Airport**  
BX/HMP 250045

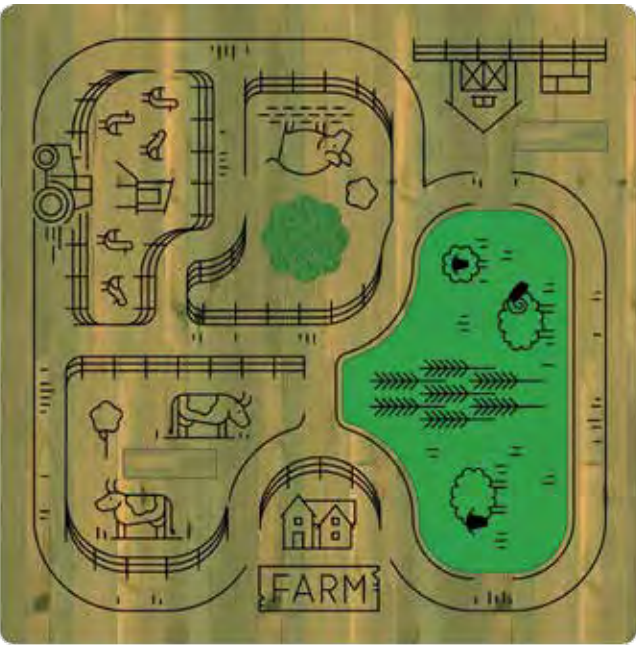

**Farm**  
BX/HMP 250046

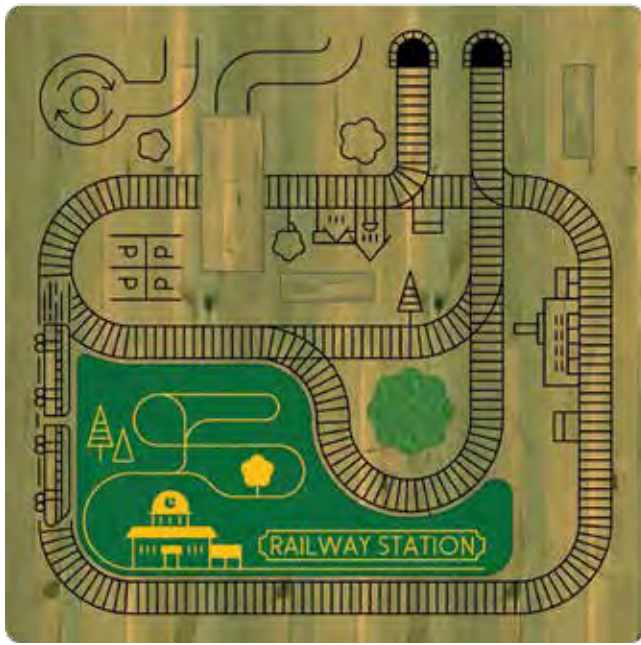

**Railway Station**  
BX/HMP 250047

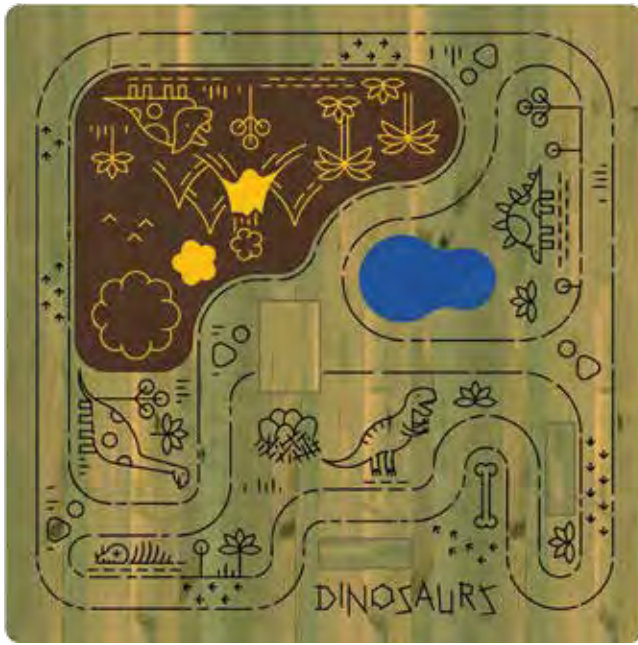

**Dinosaurs**  
BX/HMP 250048

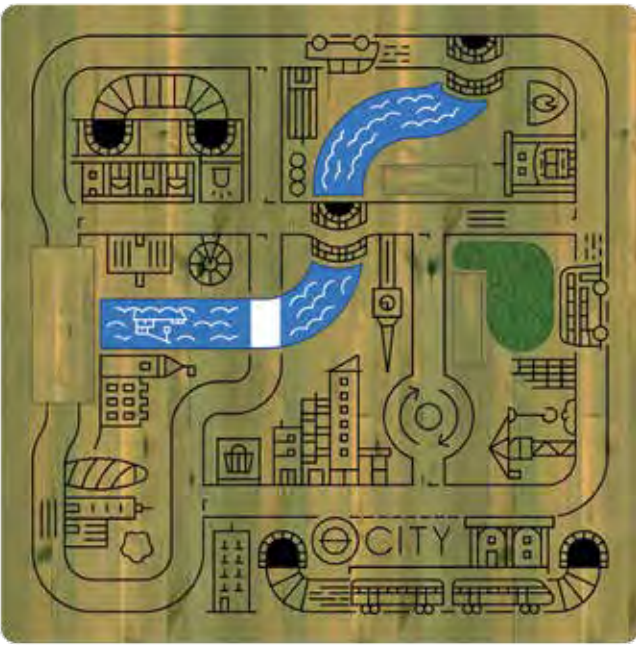

**City**  
BX/HMP 250049

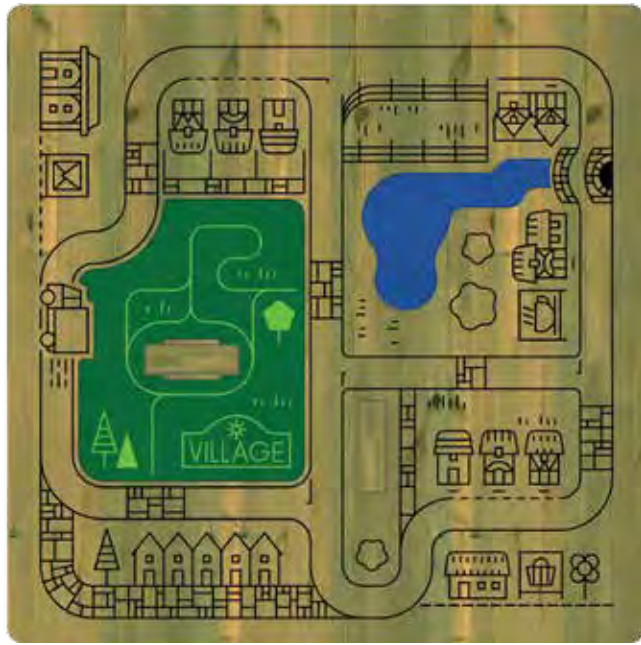

**Village**  
BX/HMP 250050



Waverley School,  
Birmingham

## Adventure Castle

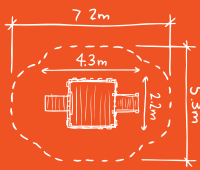

From **£2,700**

BX/HMP 250020



Windmill Primary School,  
Wellingborough

## Forest Story House

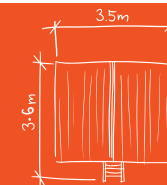

From **£2,450**

BX/PD 200009



Not quite sure what will  
work? Call us for a free  
consultation now on  
**01420 474 111**





PLAY  
SCULPTURES  
& TOTEMS

SIT  
PLAY  
EDUCATE

LET US HELP YOU DESIGN THE PERFECT  
PLAY SPACE, CALL US ON...

01420 474 111

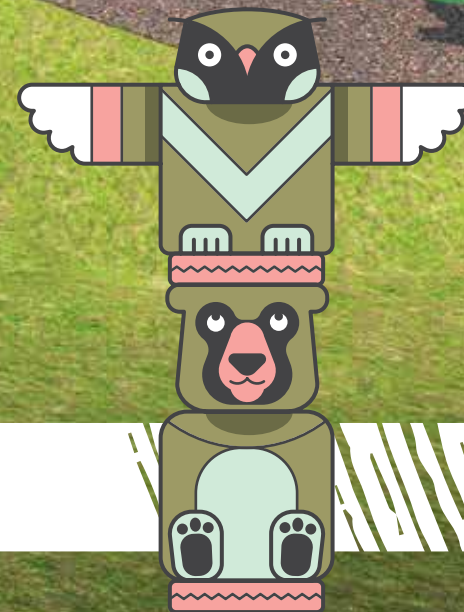





Welton Road Park

## Cow

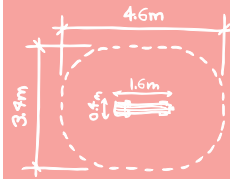

BX/HMP 350005

From **£855**



Burlington, Infant School, Surrey

## Hog

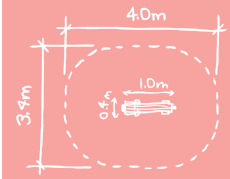

BX/HMP 350024

From **£595**



Welton Road Park

## Raging Bull

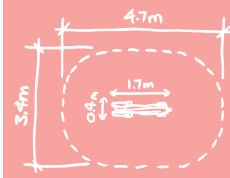

BX/HMP 350015

From **£855**



## Sheep

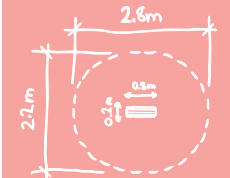

BX/HMP 350018

From **£565**

Thorn Grove Primary School



## Butterfly

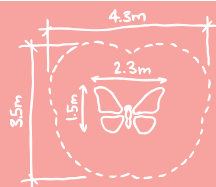

BX/HMP 350003

From **£885**



St Teresa's Catholic Primary School, Merseyside

## Grasshopper

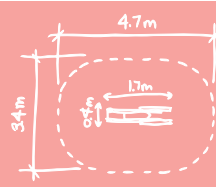

BX/HMP 350010

From **£675**



Priory R C Primary School, Torquay

## Snake

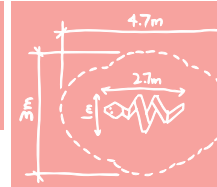

BX/HMP 350019

From **£765**



## Snail

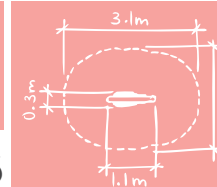

BX/HMP 350025

From **£595**



Tenterden Infant School

# Frog

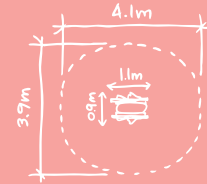

BX/HMP 350008

From **£675**

Bells Farm Primary School,  
Brockworth, Birmingham



# Bee

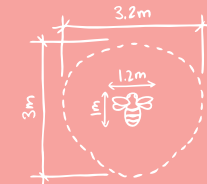

BX/HMP 350001

From **£595**



West Denton Primary School

# Dragonfly

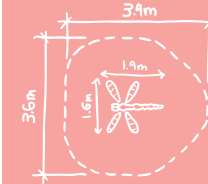

BX/HMP 350007

From **£525**



Whitehall Infant School

# Swan Seat

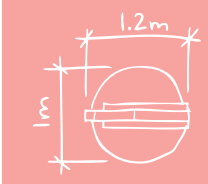

BX/HMP 350020

From **£995**



Lyndhurst Primary School, Portsmouth

## Octopus

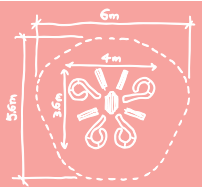

BX/HMP 350013

From **£2,950**

Downderry Primary School, London



## Shark

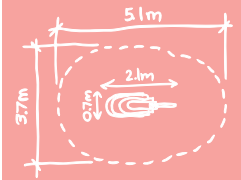

BX/HMP 350017

From **£995**



Downe Manor Primary School, Northolt, Middlesex

## Crocodile

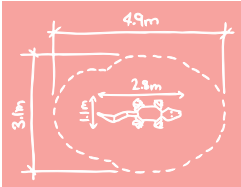

BX/HMP 350006

From **£885**



Halton Lodge

## Horse & Cart

available individually

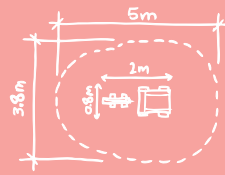

BX/HMP 350011 - Horse  
BX/HMP 350004 - Cart

BX/HMP 350012- Both

From **£1,075**

Box Primary School,  
Corsham, Wiltshire



## Big Horse

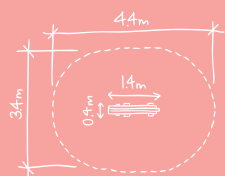

BX/HMP 350022

From **£1,175**



Downe Manor Primary School,  
Northolt, Middlesex

## Sea Monster



BX/HMP 350016

From **£1,525**



James Cook Hospital

### Sensory Totems



Hollin Primary School, Middleton, Manchester



### Sight & Colour

BX/HMP 750004

From £175



Rossmere Primary School

## Sound & Hearing

BX/HMP 750005

From **£175**



St Teresa's Catholic Primary School

## Taste & Smell

BX/HMP 750007

From **£175**



Christ Church Primary School,  
Burton  
Upon Trent

## Touch & Movement

BX/HMP 750008

From **£175**



Howes Primary School,  
Coventry

## Spirit & Time

BX/HMP 750006

From **£175**

Lingey House Primary School,  
Gateshead



### Kolus Totem

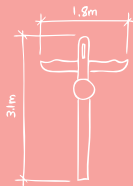

BX/HMP 750011

From **£500**



Agar Children's Centre

### Totem Forest

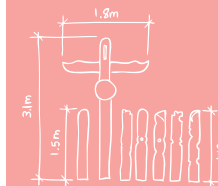

BX/HMP 750010

Includes: 1 Kolus, 5 Sensory, 1 Prairie & 1 Savannah Totem

From **£1,450**





Agar Children's Centre

## Prairie

BX/HMP 750002

From **£175**



Agar Children's Centre

## Savannah

BX/HMP 750003

From **£175**

## BESPOKE OPTIONS

CREATE SOMETHING UNIQUE TO YOUR PROJECT WITH OUR BESPOKE ENGRAVING SERVICE.

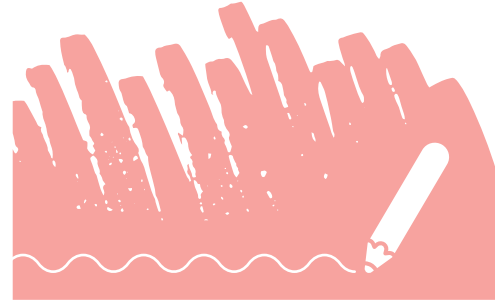

Houndsfield Primary School, Edmonton, London

A friend is like a rose to smell

A friend is beautiful like a teddy

# Animal Faces



We've added a whole menagerie of animal faces to our play sculptures and totems category. Some are exotic whilst some are recognisable species that live locally. Children can identify the creatures that inhabit their surroundings.



From **£245**  
each



Hillside Specialist School



**Owl**  
BX/HMP 750016



**Hedgehog**  
BX/HMP 750019



**Butterfly**  
BX/HMP 750020



**Spider**  
BX/HMP 750021



**Frog**  
BX/HMP 750023



**Bee**  
BX/HMP 750017



**Deer**  
BX/HMP 750018



**Dragonfly**  
BX/HMP 750024



**Ladybird**  
BX/HMP 750025



Woodpecker

BX/HMP 750026



Badger

BX/HMP 750027



Kangaroo

BX/HMP 400035



Dog

BX/HMP 400036



Tiger

BX/HMP 400031



Panda

BX/HMP 400032



Zebra

BX/HMP 400037



Chimp

BX/HMP 400038



Pig

BX/HMP 400033



Hippo

BX/HMP 400034



Rabbit

BX/HMP 400039



Lion

BX/HMP 400040



Maple Leaf Table & Leaf Seats

Modular Radius Seats

Storyteller's Chair

Amazing Seating

Oak Leaf Table & Leaf Seats

T-Frame Picnic Table

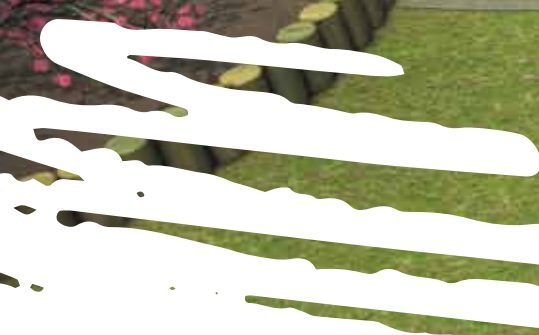

# SEATING

SOCIALISE  
REST  
CONDUCT

BOOK YOUR FREE PLAYGROUND CONSULTATION, CALL US ON...

01420 474 111



Howes Primary School,  
Coventry



## Storyteller's Chair

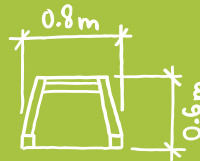

BX/HMP 450028

From **£520**

Hazlewood School



SEATING

## Block Seat

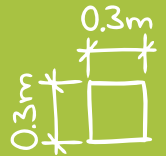

BX/HMP 450003

From **£125**



Colebrook Junior School,  
Swindon

## Story Circle

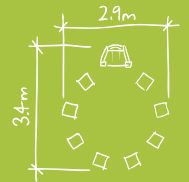

BX/HMP 450029

From **£1,425**



Shireland Hall Primary School, Birmingham

### Modular Radius Seat

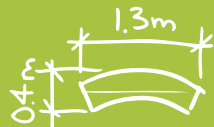

BX/HMP 450016

From **£230**



### Horseshoe Bench

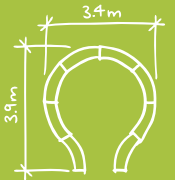

BX/HMP 450012

From **£2,155**



Howes Primary School, Coventry

### Serpent Bench



BX/HMP 450038

From **£2,200**

# Engraved Button Stool



Over the years we've produced bespoke engravings for our customers who required something specific. LOOK OUT FOR THE PENCIL ICON on our other customisable products.



From £75



**Bee**  
BX/HMP 450040



**Spider**  
BX/HMP 450041



**Ant**  
BX/HMP 450042



**Butterfly**  
BX/HMP 450043



**Snail**  
BX/HMP 450044



**Moth**  
BX/HMP 450045



**Ladybird**  
BX/HMP 450046



**Centipede**  
BX/HMP 450047



**Dragonfly**  
BX/HMP 450048



St Teresa's Catholic Primary School

### Tree Seat

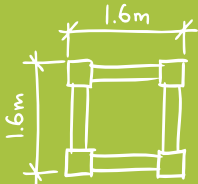

BX/HMP 450013

From **£620**



St Teresa's Catholic Primary School

### Buddy Bus Stop



BX/HMP 450004

From **£320**



Deepdale Shopping Park

### Wave Bench

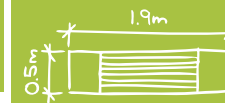

BX/HMP 450032

From **£915**



### Humpty Bench

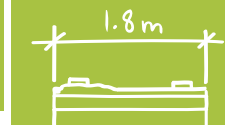

BX/HMP 450070

From **£450**





Downe Manor  
Primary School,  
Middlesex

## Games Picnic Table

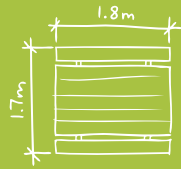

BX/HMP 450064

From **£805**



Dumbarton Academy,  
Dunbartonshire

## T-Frame Picnic Table

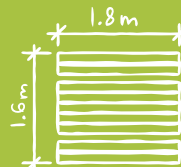

BX/PD 450018

From **£295**



St Joseph's Catholic School,  
Winsford

## H-Frame Picnic Table

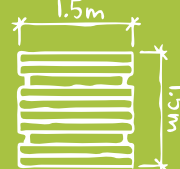

BX/PD 450005

From **£295**



Saint Mary's School,  
Scotland

## Roofed Table

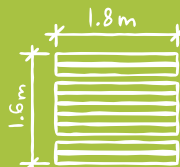

BX/PD 450013

From **£935**



Downe Manor Primary School, Middlesex

### Oak Leaf Table

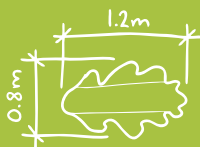

BX/HMP 450021

From **£455**



Cottage Grove Primary School, Southsea, Hampshire

### Maple Leaf Table

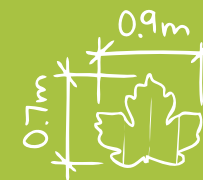

BX/HMP 450034

From **£455**



Meols Parade Gardens, Wirral

### Flower Table

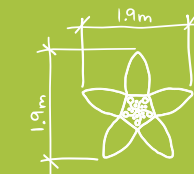

BX/HMP 450067

From **£1,075**



**Holly**  
BX/HMP 450011 From **£85**

**Beech**  
BX/HMP 450002 From **£85**



**Oak**  
BX/HMP 450020 From **£85**

**Maple**  
BX/HMP 450014 From **£105**



**Sycamore**  
BX/HMP 450030 From **£105**

**Leaf Seats**

- 2+
- 4.2 M2
- 0.4m
- FSC

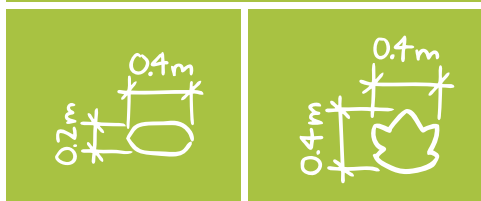

**Hand Seat**

- 2+
- 2.5 M2
- 1.3m
- FSC

BX/HMP 450009 From **£495**



Hiltonbury Infants School,  
Chandlers Ford,  
Hampshire

### Shell Seat

2+ 4.1 M2 0.3m FSC

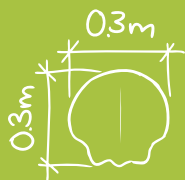

From **£100**

BX/HMP 450025



Houndsfield Primary School,  
Edmonton, London

### Starfish Table

2+ 12.6 M2 0.4m FSC

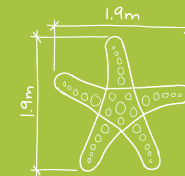

BX/HMP 450027

From **£800**



Stanton Bridge  
Primary School,  
Coventry

### Share Chair

2+ 6.8 M2 1.2m FSC



BX/HMP 450024

From **£405**

## BESPOKE OPTIONS

Complete with engravings our Minibeast Seats look amazing in natural settings but you may have a specific type of bug in your nature area...

[GO TO PAGE 14 FOR MORE INFO...](#)



**Bee**

BX/HMP 450058



**Snail**

BX/HMP 450059



**Butterfly**

BX/HMP 450060



**Ladybird**

BX/HMP 450061

### Butterfly Table

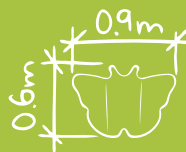

BX/HMP 450057

From **£575**

### Minibeast Seats

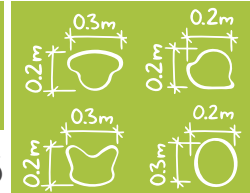

From **£125**

Pathfield School Barnstaple,  
Devon



### Square Table

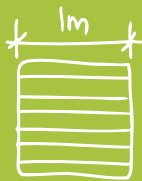

BX/HMP 450039

From **£400**



Shireland Hall  
Primary School,  
Birmingham

### Round Table

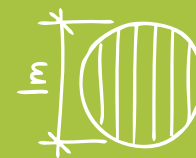

BX/HMP 450036

Smooth top version also available

From **£400**



St George's C of E  
Primary School,  
Stamford

### Hexagonal Table

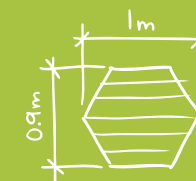

BX/HMP 450010

Smooth top version also available

From **£400**

# BESPOKE OPTIONS

Our engraved Benches and Seats allow children to take rubbings which they can pin up in class. If you'd like something different to these, GET IN TOUCH...

01420 474 111

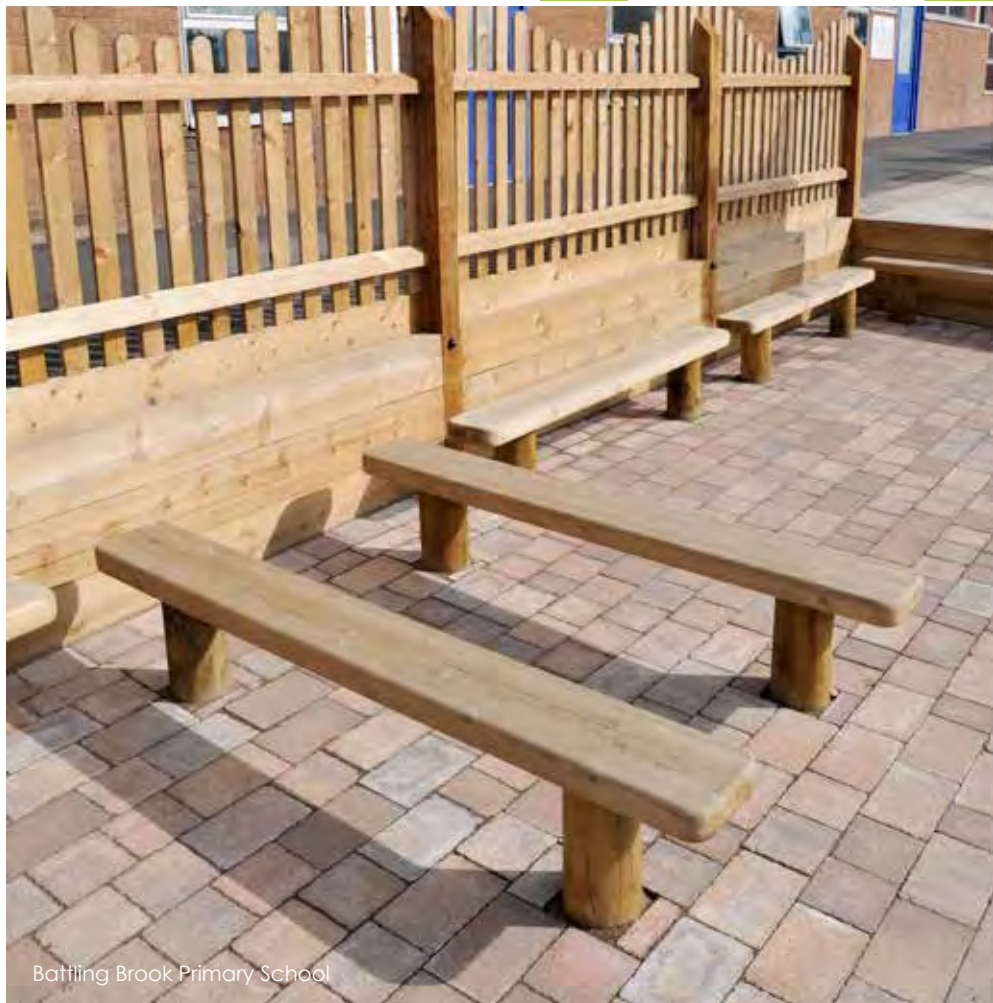

Batling Brook Primary School

## Standard Bench



BX/HMP 450006

From **£185**



Maple Court Academy

## Solar System



Priory RC Primary School  
Torquay

## Leaf



Maple Court Academy

## Tracker



Maple Court Academy

## Minibeast

## Engraved Bench



BX/HMP 450006

From **£220**

Vickerstown Primary School,  
Barrow In Furness, Cumbria



## Wishing Chair

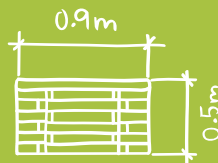

BX/HMP 450033

From **£780**



Colebrook Junior School,  
Swindon

## Mini Maze

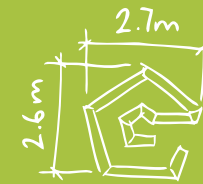

BX/HMP 450015

From **£795**



Camphill School

## Octagonal Amazing Seating

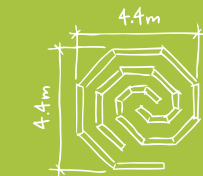

BX/HMP 450022

From **£2,295**





St Stephen and All Martyrs' C of E Primary School

Like many of our seats, the Amazing Seating can be engraved with your choice of text or logos. Past bespoke engravings include phrases, Minibeasts and illustrations created by children. Take a peek at page 14 to see a few of our bespoke engravings.

## Amazing Seating

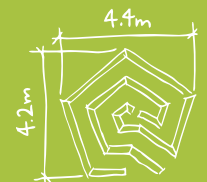

BX/HMP 450001

From **£1,450**

Darell Gazebo

Asymmetric Grace Shelter

Malvern

OUTDOOR  
CLASSROOMS,  
SHELTERS  
& SHADES

GATHER  
SHELTER  
LEARN

WANT EXPERT HELP WITH PLANNING  
YOUR SPACE? CALL US ON...

01420 474 111



# GAZEBO OPTIONS

Our gazebos include options for fencing and seating plus other additional extras. The Darell even has a number of roofing options, including featheredge, cedar shingle and fabric.



Coopers Edge School, Brockworth, Gloucester

## Darell Gazebo

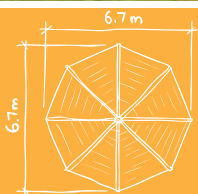

BX/HMP 200012

From **£4,310**

Broadstone Hall Primary School, Stockport



## Caversham Gazebo

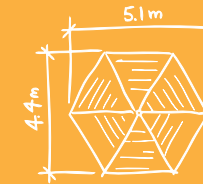

BX/HMP 200016

From **£3,725**



Djanogly Northgate Academy, Nottingham

## Willingdon Gazebo

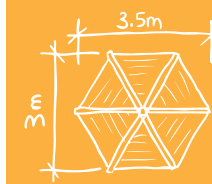

BX/HMP 200013

From **£1,530**



St Catherine's Primary School  
Manchester

## Grace Shelter



Size  
options  
available

BX/HMP 200020  
Symmetric & Asymmetric options available

From **£POA**



Anglesey Primary School,  
Birmingham

## Anglesey Pavilion

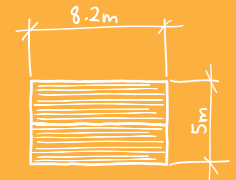

BX/HMP 200021

From **£13,595**



Reay Primary School

## Lunar Shelter

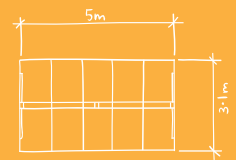

BX/HMP 200005

From **£3,385**



Stebdon Primary School,  
London



Our Lady Catholic School,  
Nottingham

Polycarbonate  
Pergola



Size  
options  
available

BX/HMP BSP-SHELTER

£POA

# PERGOLA OPTIONS

We offer a complete variety of sizes, shapes and heights to meet your specifications. You may also want to include guttering, end panels, side panels, roll up vinyl blinds, play panels and furniture. The options are endless....

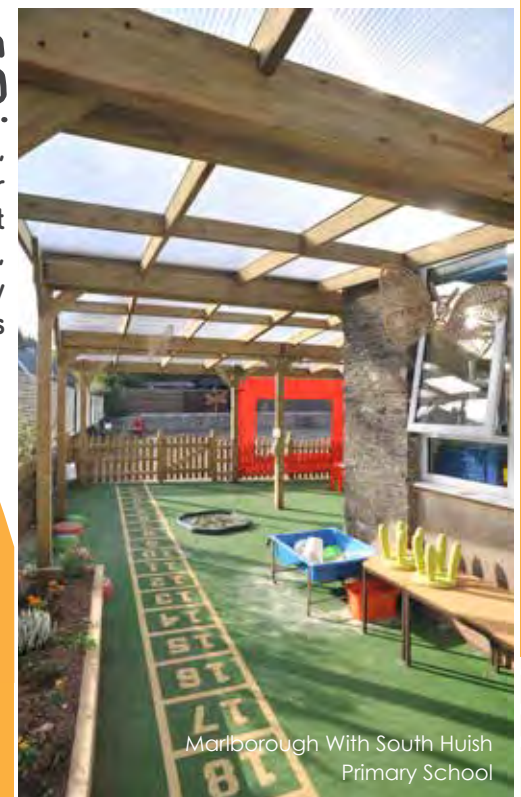

Marlborough With South Huish  
Primary School



Colston Primary School

# CANOPY OPTIONS

Choose from a variety of colours, shapes and sizes as well as UV Shade or waterproof material.

## Breathable UV Shade Colour Options:

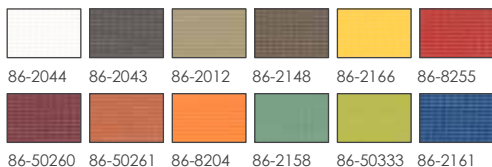

## Waterproof Colour Options:

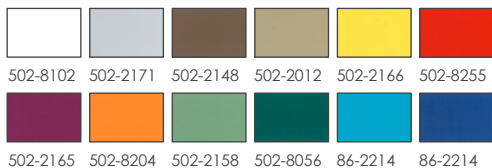

St Mary & All Saints CE Primary School

## Sail Canopy



Size options available

BX/HMP 200018 Breathable UV Shade  
BX/HMP 200019 Waterproof

EPOA



Houndsfield Primary School, Edmonton, London

## Westgate

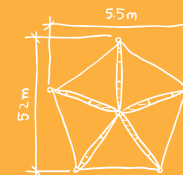

BX/HMP 200008

From £3,295



Morgan's Vale & Woodfalls Primary School, Wiltshire,

## Barge Classroom

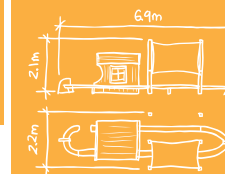

BX/HMP 200001

From £3,895



Downe Manor Primary School, Middlesex

**Malvern**

BX/HMP 200007  
Seating not included

From **£4,995**

5.5m



Raglan School, Bromley, Kent

**Longboat**

BX/HMP 200006

From **£4,595**

4.9m

**Varndean**

BX/HMP 200022

From **£14,800**

14.2m

6m



Tubular Bells

Chimes

Super Star Stage

Sound Centre

Congas

Turtle Drum

Akadinda

MUSIC & PERFORMANCE

PERFORM  
SING  
SHINE

LET US HELP YOU DESIGN THE PERFECT PLAY SPACE-CALL US ON...

01420 474 111

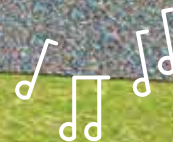



# Super Star Stage



Our standard Star and Super Star Stages are supplied with two tiers but we can offer options of less or more depending on the scale of your project.



BX/HMP 650049

From **£2,745**



Thorn Grove Primary School

# Star Stage



BX/HMP 650046

Single tiered option also available

From **£915**

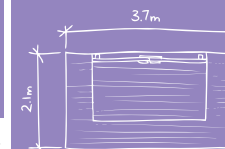

Lingey House Primary School, Gateshead

Chalk Board panel



Lingey House Primary School, Gateshead

# Puppet Theatre Screen



BX/HMP 650043

From **£1,375**

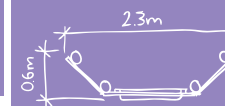

Ysgol Y Gogarth,  
Llandudno



### Petal Drum



From **£695**

BX/HMP 650047



Durrington Middle School

### Tubular Bells

available in silver only

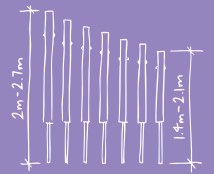

BX/HMP 650000 From **£2,270** Set of 7 From **£350** Individual



Djanogly Northgate Academy

### Percussion Post



Single sided or double sided From **£325**

BX/HMP 650902

Stanton Bridge Primary School,  
Coventry



## Sound Centre

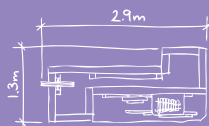

BX/HMP 650045

From **£2,250**



Meols Parade Gardens,  
Wirral

## Rainwheel

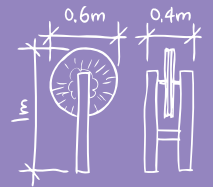

BX/HMP 650004

From **£595**



Thorn Grove Primary School

## Chimes

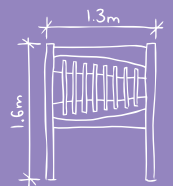

BX/HMP 650001

From **£565**



# Papilio Bells

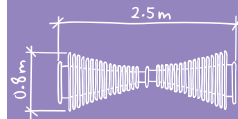

BX/HMP 650023

From **£2,270**



St Peters CE Primary School

# Akadinda

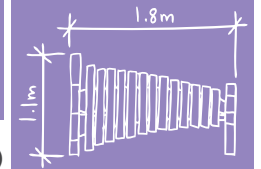

BX/HMP 650018

From **£1,700**



# Congas

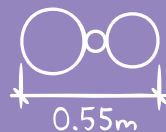

BX/HMP 650039

Available in S.M.L & Trio (Set) From **£485** each



# Sonora

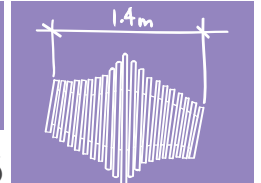

BX/HMP 650028

From **£2,695**



Rooks Nest Academy

## Glockenspiel

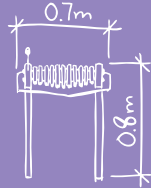

BX/HMP 650002

From **£605**



St Joseph's Catholic School,  
Winsford

## Cow Bells

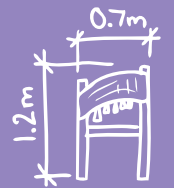

BX/HMP 650903

From **£355**



## Grand Marimba

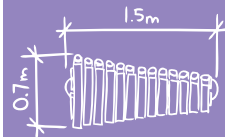

BX/HMP 650008

From **£2,970**



Vickerstown Primary School,  
Barrow In Furness, Cumbria

## Turtle Drum

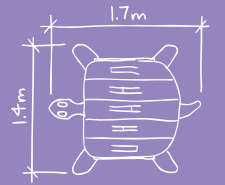

BX/HMP 650007

From **£855**

# Freechimes



Freechimes can be mounted almost anywhere, whether it's on a wall or on one of our Outdoor Classrooms. All you need to decide is how many you'd like...

BX/HMP 650041

From **£485** a set

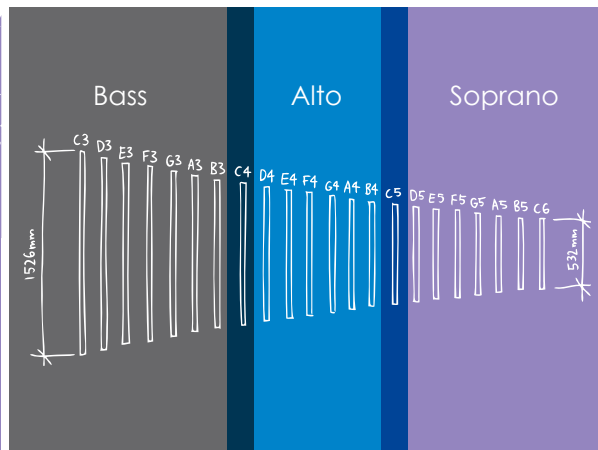
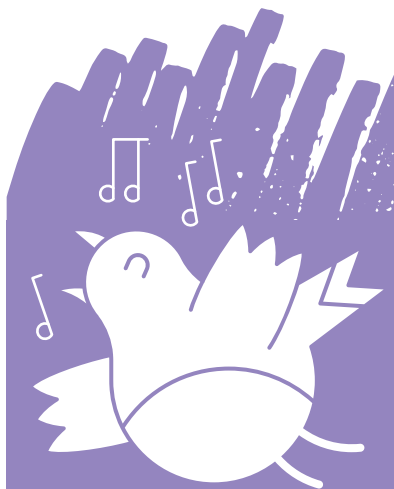

St Joseph's Catholic School, Winsford



**Duo**

3+ 7.1 M2 0.9m

BX/HMP 650025    Material & colour options available, From **£2,155**



**Sansa - Rimba**

3+ 5.7 M2 1m

BX/HMP 650020    Material & colour options available, From **£1,350**



Panda Drum



BX/HMP 650040

From **£1,335**



Lion  
Glockenspiel

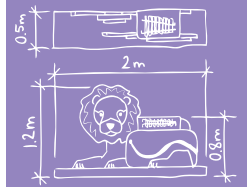

BX/HMP 650003

From **£1,335**



The Village School,  
London

Tiger  
Glockenspiel

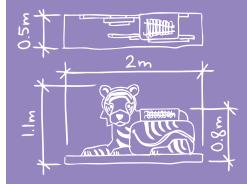

BX/HMP 650006

From **£1,335**



Extra Large Sand Pit

Pedestal Sand Pit

Atlantic 1

SAND & WATER PLAY

SPLASH  
DIG  
BUILD

BOOK YOUR FREE PLAYGROUND CONSULTATION, CALL US ON...

01420 474 111







Howes Primary School,  
Coventry

## Extra Large Sand Pit

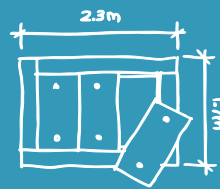

BX/HMP 250032

From **£1,375**



## Large Sand Pit

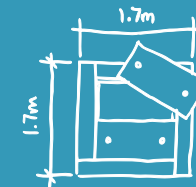

BX/HMP 250031

From **£915**



Haydock Surestart  
Children's Centre,  
Hatdock, St Helens

## Standard Sand Pit

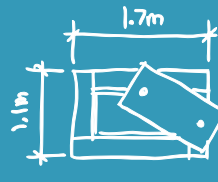

BX/HMP 250027

From **£595**

Hamilton Sure Start  
Children's Centre,  
Leicester



### Windmill Sand Pit

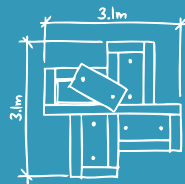

BX/HMP 250021

From **£2,295**



Ridgeway School

### Pedestal Sand Pit

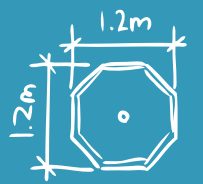

BX/HMP 800007

From **£1,250**



Maple Court Academy

The Boat Sand Pit is a great way to add both imaginative and educational elements into your project. With the addition of our Ocean Water System you can create a sea themed area that's fun for all ages and aspects of play. Turn the page for more info...

**Boat Sand Pit**

- 3+
- 22 M<sup>2</sup>
- 0.6m
- 2.3m
- FSC

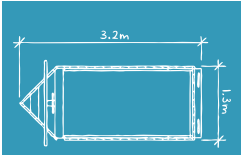

BX/PD 250003 From **£2,310**

# Atlantic 1



Our Atlantic Water System is made up of three key components, the tray, chute and seabed platform. This allows you create a water play zone to suit any space.

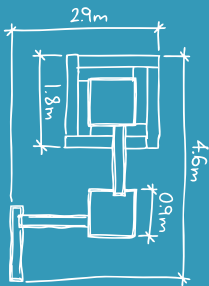

BX/HMP 250022

From **£2,685**

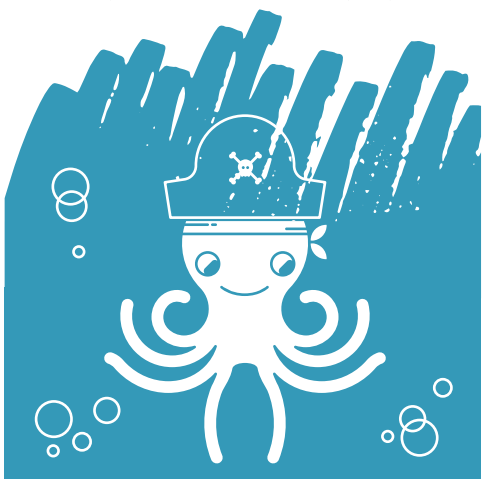



Boughton Heath Primary School

## Ocean Water Chute

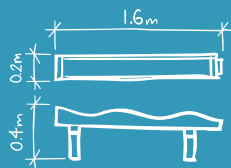

BX/HMP 250023

From **£250**



Stanton Bridge Primary School, Coventry

## Seabed Platform

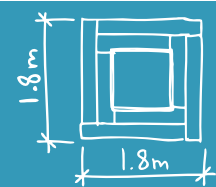

BX/HMP 250026

From **£1,355**



Rudheath Primary Academy

## Ocean Tray

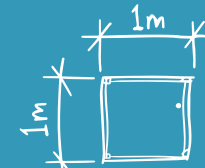

BX/HMP 250025

From **£745**



Boughton Heath Primary School

## Tray & Chute Combo

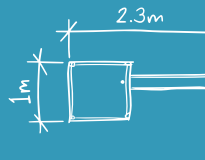

BX/HMP 250024

From **£995**

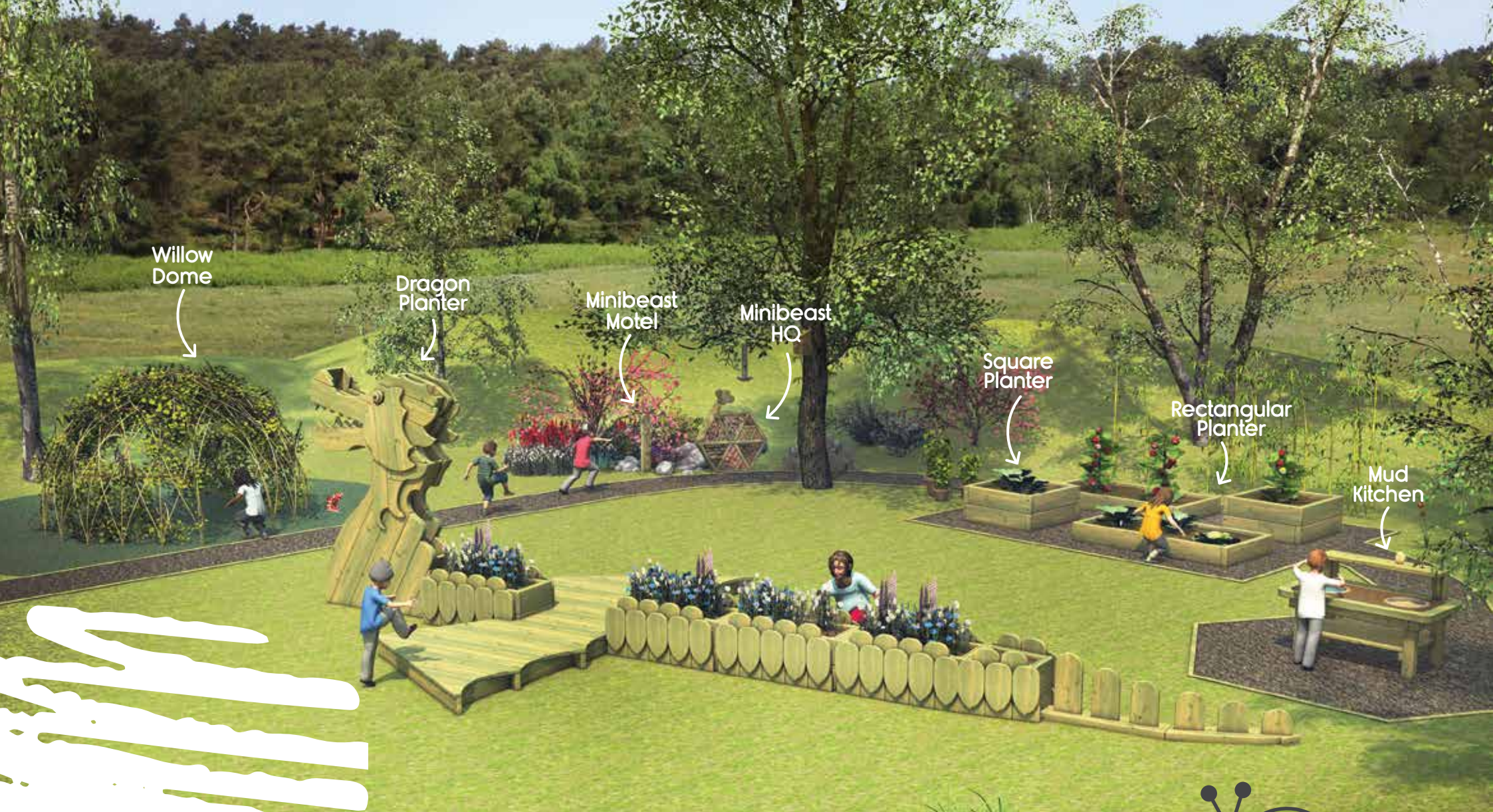

Willow Dome

Dragon Planter

Minibeast Motel

Minibeast HQ

Square Planter

Rectangular Planter

Mud Kitchen

GROWING,  
PLANTING &  
NATURE

NURTURE  
CONSERVE  
BLOOM

WANT EXPERT HELP WITH PLANNING  
YOUR SPACE? CALL US ON...

01420 474 111





### Dragon Tail



### Dragon Wings



### Dragon Body



### Dragon Head



BX/HMP 400021

From **£205** per metre

BX/HMP 400026

From **£985**

BX/HMP 400019

From **£390** per metre

BX/HMP 400020

From **£2,950**



Marlborough With South  
Huish Primary School

## Rectangular Planter

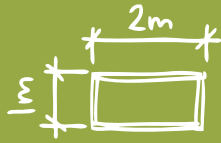

BX/HMP 400906

From **£430**



Our Lady and St Edward's  
Catholic Primary School

## Window Planter

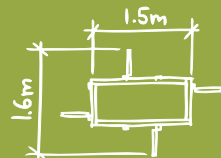

BX/HMP 550006

From **£1,150**

St Joseph's Catholic School,  
Winsford



## Corner Planter

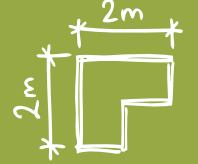

BX/HMP 400907

From **£505**



Earcroft Children's Centre,  
Darwen

## Square Planter



BX/HMP 400905

From **£305**





St Teresa's Catholic Primary School

## Stack Planter

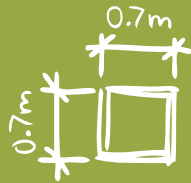

BX/HMP 400910

From **£365**



Vickerstown Primary School, Barrow In Furness, Cumbria

## Hexagonal Planter

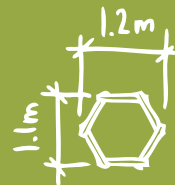

BX/HMP 400904

From **£385**



# PLANTER OPTIONS

All of our planters are available in a variety of heights from 1 board high upwards which, combined with our different shapes, allow for dynamic arrangements.



Our Lady Catholic School, Nottingham

## Right Angle Planter

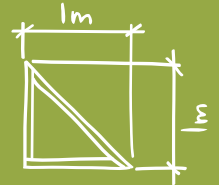

BX/HMP 400909

From **£430**



Moorlands Children's Centre, Biddulph

### Sensory Planter

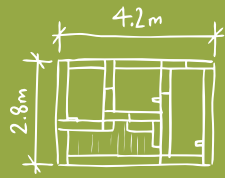

BX/HMP 400022

From **£3,215**



Mud not included!

Rudheath Primary Academy

### Mud Kitchen

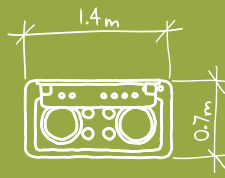

BX/HMP 250040

From **£735**



St Peters CE Primary School

### Swan Planter

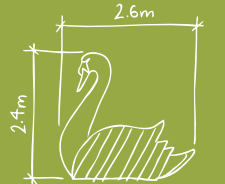

BX/HMP 400023

From **£2,850**



## Compost Cottage

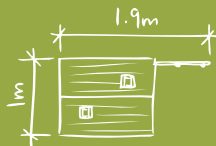

BX/HMP 550001

From **£995**

# SIGN OPTIONS

EACH VEGETABLE PLANTER COMES WITH YOUR CHOICE OF 4 VEGETABLE SIGNS.



St Teresa's Catholic Primary School

## Vegetable Planter

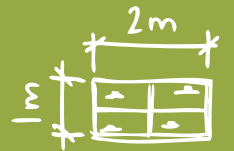

BX/HMP 550901

From **£730**



White Rock Primary School, Paignton

**Willow Tunnel**

3+ 11.3 M2 1.4m

From **£POA**



Cottage Grove Primary School, Southsea, Hampshire

**Willow Dome**

3+ 17.6 M2 2m

From **£POA**

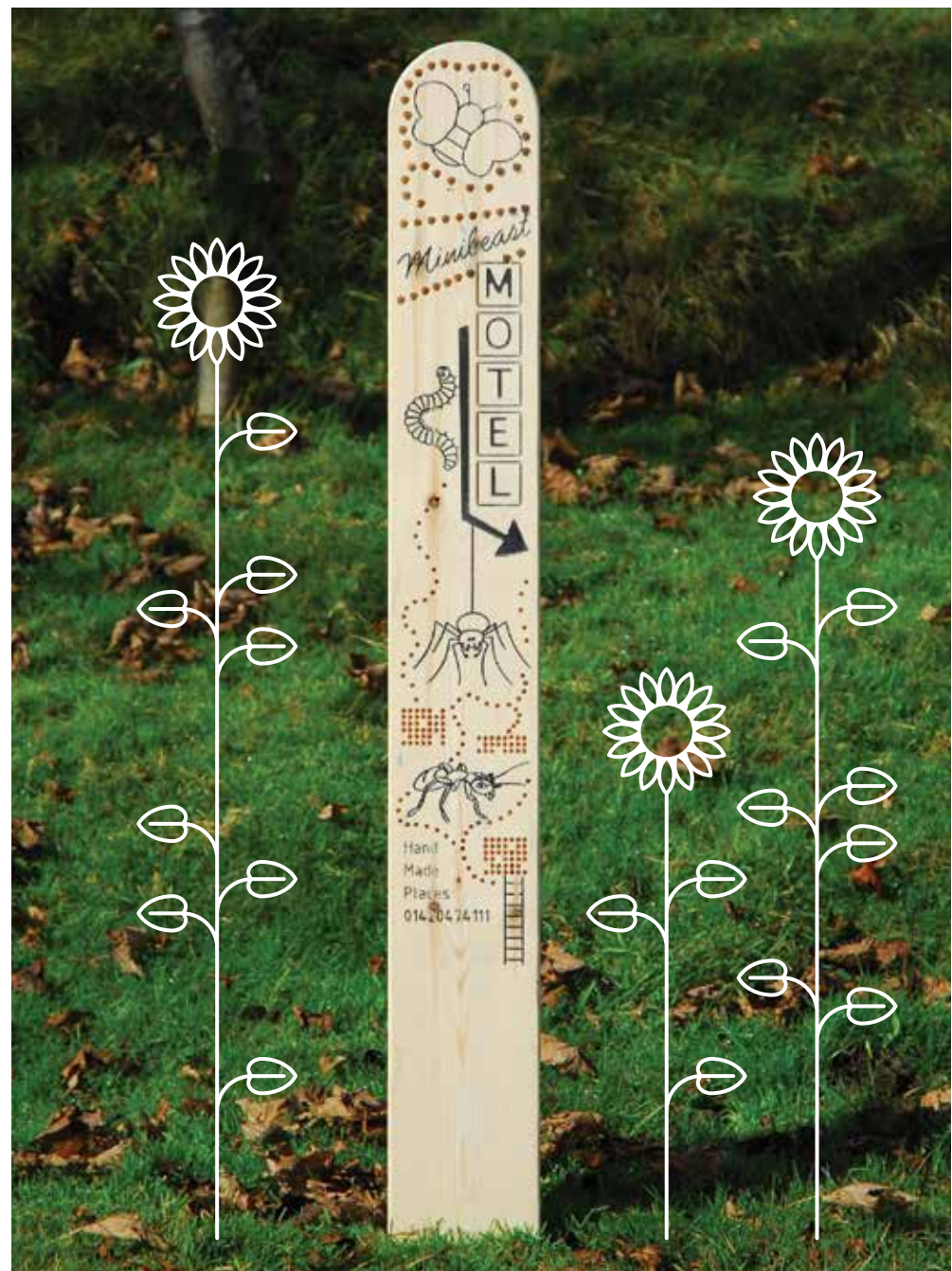

**Minibeast Motel**

3+ 3.5 M2 0.9m

From **£95**

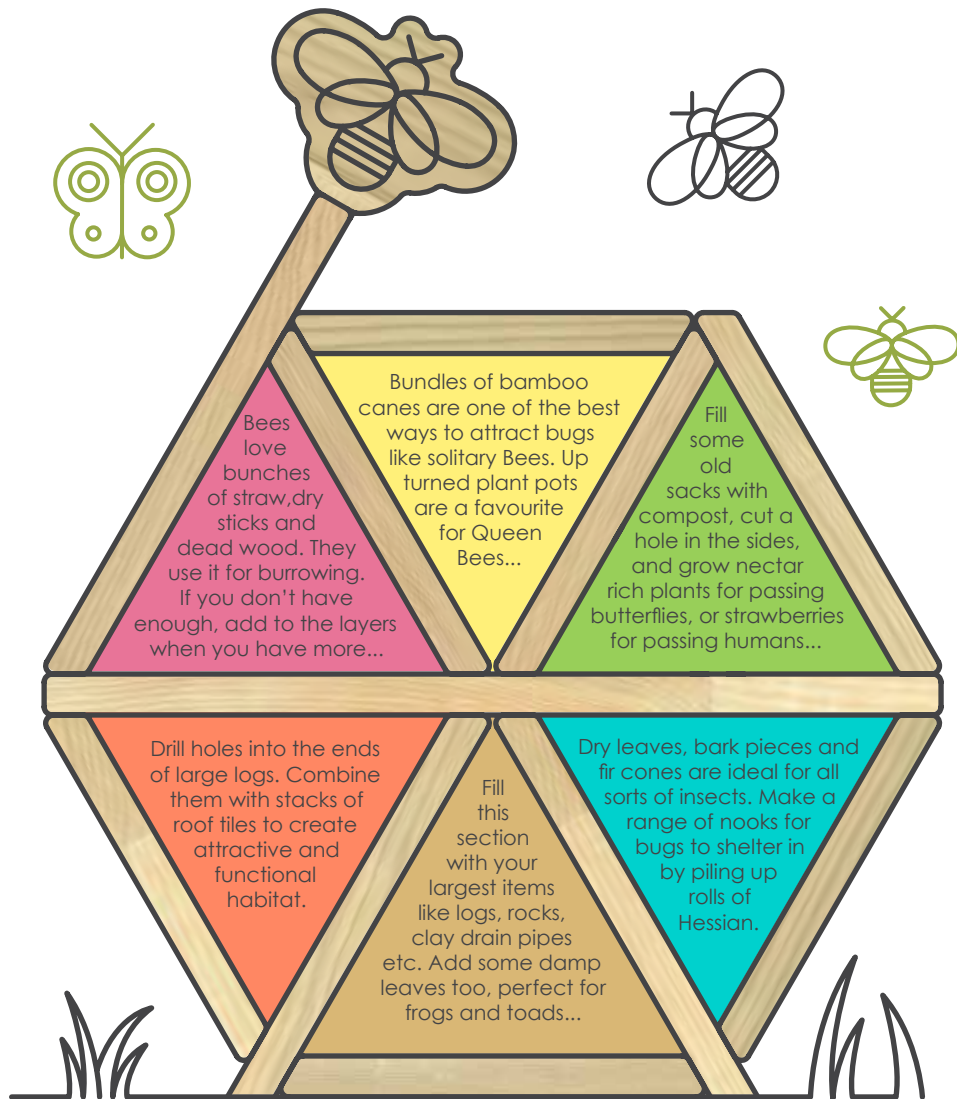

## THE HQ GUIDE

OTHER GOOD TIPS FOR ENCOURAGING MINIBEASTS TO YOUR HQ ARE...

- PLACE IT UNDER A TREE OR NEAR A SHELTERED WALL
- PILE SOME ROTTEN LOGS AROUND THE BASE
- GROW WILD FLOWERS IN THE AREA
- TRY NOT TO DISTURB IT ONCE ESTABLISHED

### Minibeast HQ

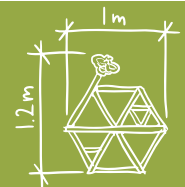

BX/HMP 550008

From **£425**

Ocean  
Finger  
Maze

Chalk  
Board

Activity  
Wall

Dry Wipe  
Board

Woodland  
Finger  
Maze



ACTIVITY  
PANELS

INVENT  
CREATE  
EXPRESS

NOT QUITE SURE WHAT WILL WORK?  
CALL US NOW ON...

01420 474 111





Stanton Bridge Primary School,  
Coventry

## Activity Wall

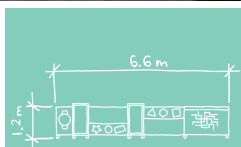

BX/HMP 400029

From **£2,985**



Eastfield Nursery School  
& Children's Centre,  
Wolverhampton

## Ladder Rattle

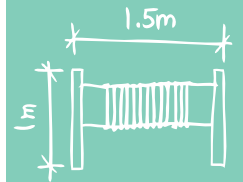

BX/HMP 400010

From **£395**



Boughton Heath  
Primary School

## Dizzy Disc

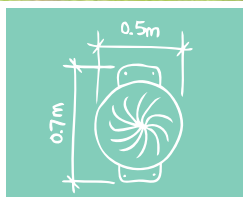

BX/HMP 400007

From **£205**

Finger Mazes can be wall mounted as standard or post mounted as an additional extra.

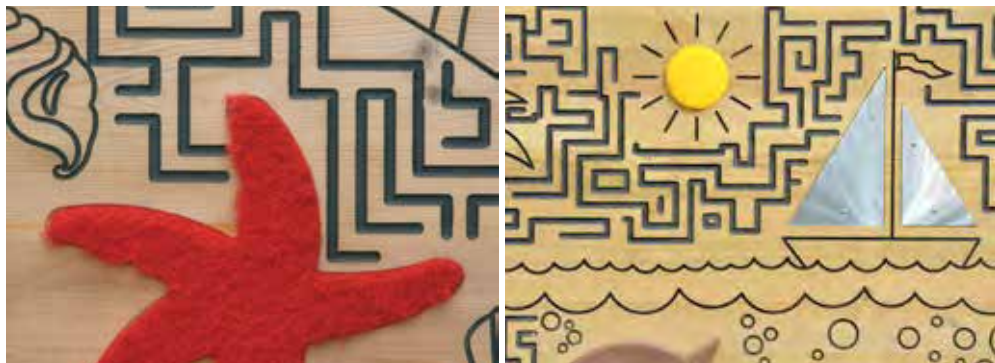
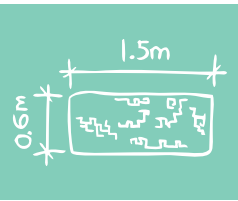

Stanton Bridge Primary School, Coventry

### Ocean Finger Maze

2+ 3.5 M2 0.6m FSC

From £335

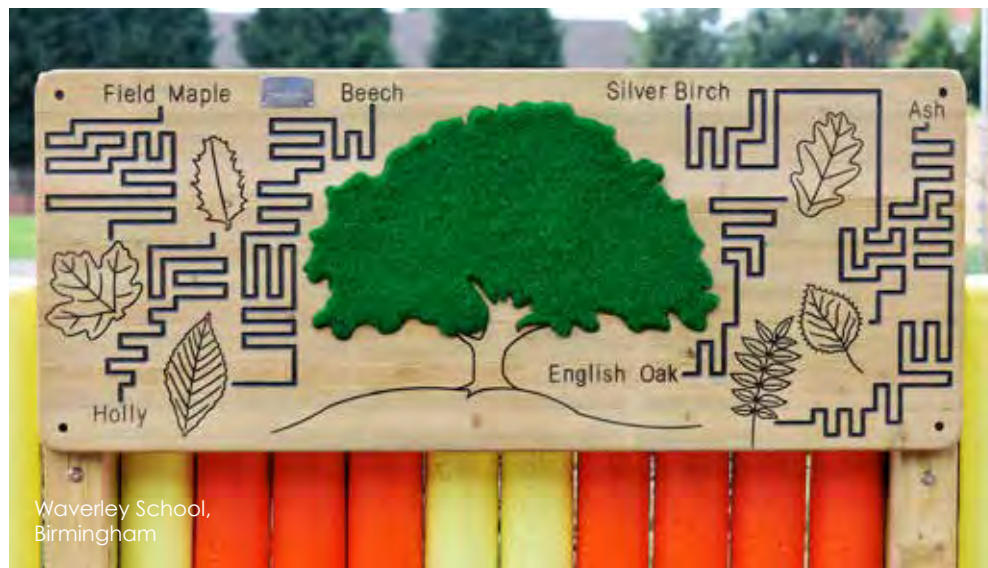

Waverley School, Birmingham

### Tree Finger Maze

2+ 3.5 M2 0.6m FSC

BX/HMP 400016

From £335



Tenterden Infant School

### Woodland Finger Maze

2+ 3.5 M2 0.6m FSC

BX/HMP 400014

From £335





Tenterden Infant School

## Beehive Finger Maze



BX/HMP 400002

From **£335**

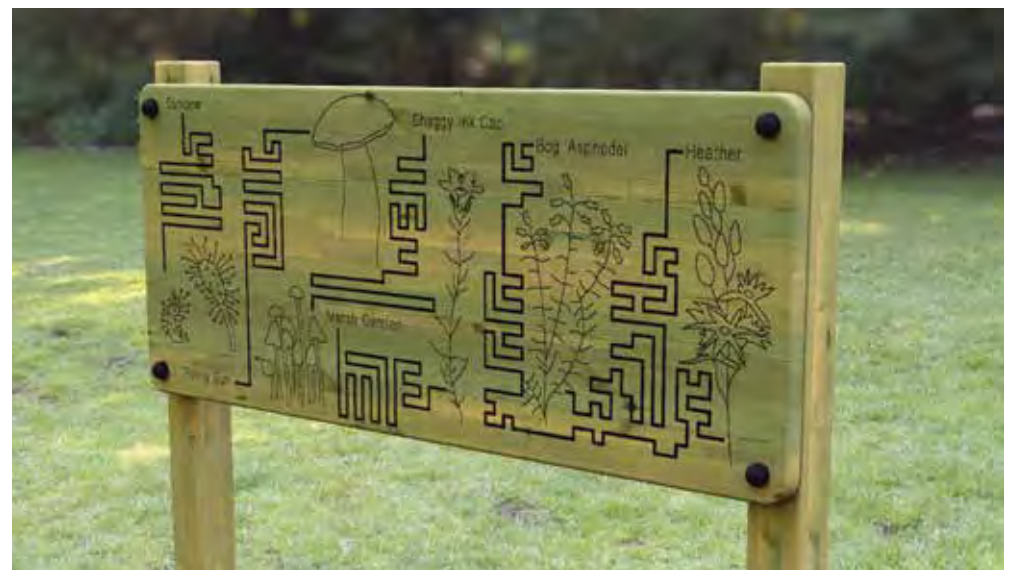

## Heathland Finger Maze



BX/HMP 400017

From **£335**



Broadstone Hall Primary School

## Wildlife Finger Maze



BX/HMP 400015

From **£335**



Dorothy Goodman School

## Harvest Finger Maze



BX/HMP 400008

From **£335**

White Rock Primary School,  
Paignton



### Concave Mirror

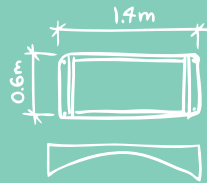

BX/HMP 400005

From **£520**



Eastfield Nursery School & Children's Centre,  
Wolverhampton

### Tracing Board

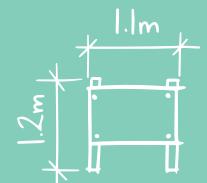

BX/HMP 400903

From **£295**



West Acklam Clinic,  
Middlesbrough

### Flat Mirror

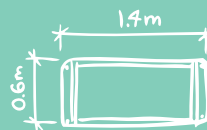

BX/HMP 400028

From **£485**



The Harry Taylor First School

### Convex Mirror

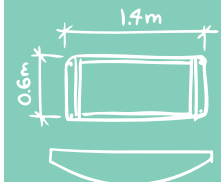

BX/HMP 400006

From **£520**



Kettering Park Infant School

## Blackboard

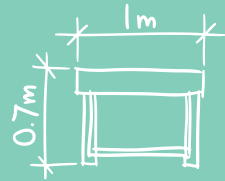

BX/HMP 400003

From **£360**



Agar Children's Centre

## Whiteboard

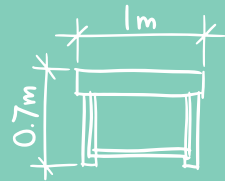

BX/HMP 400013

From **£360**



Stanton Bridge Primary School, Coventry

## Dry Wipe Board

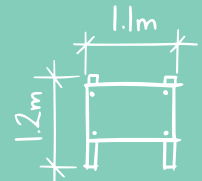

BX/HMP 400901

From **£295**



Rowena Academy, Doncaster

## Chalk Board

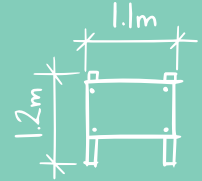

BX/HMP 400902

From **£255**



## Writing Patterns

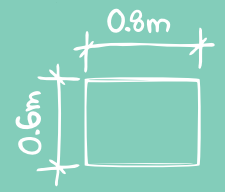

BX/HMP 400004

From **£295**



## Today's date is...

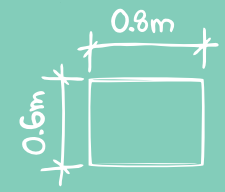

BX/HMP 400004

From **£170**



## Noughts

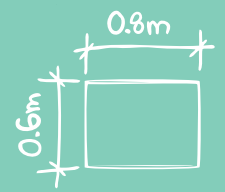

BX/HMP 400004

From **£235**

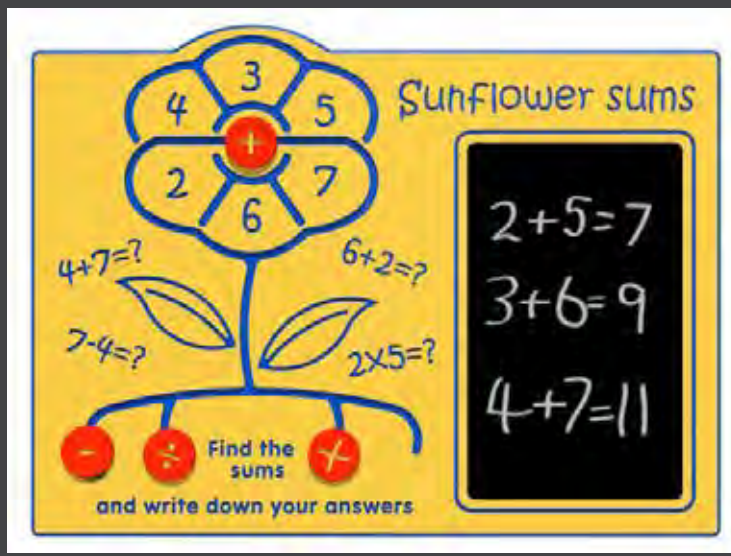

## Sunflower Sums

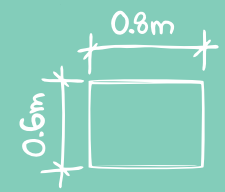

BX/HMP 400004

From **£285**



Alphabet Upper & Lower Case

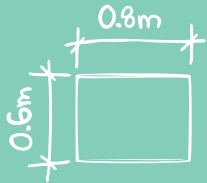

BX/HMP 400004

From £105

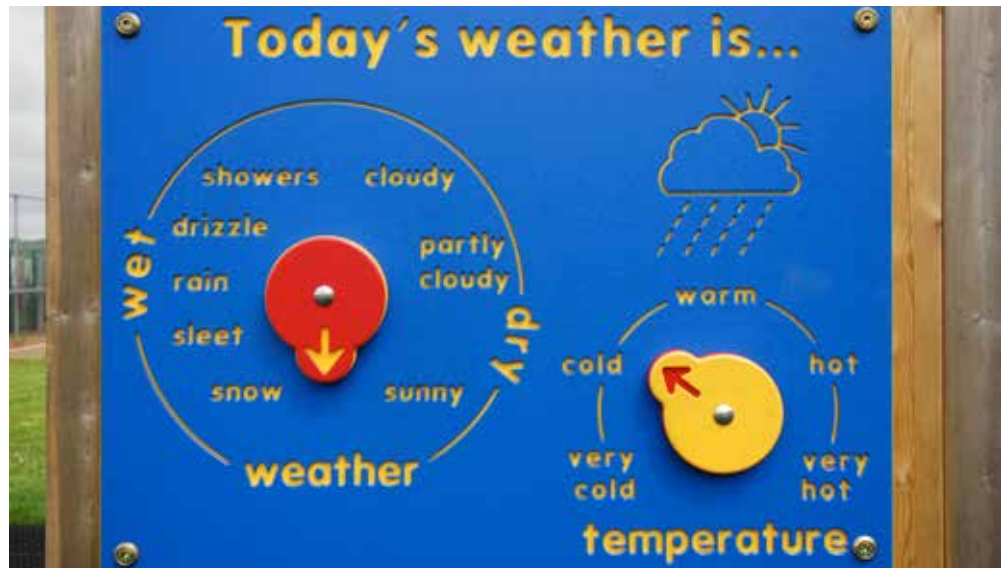

Today's weather is...

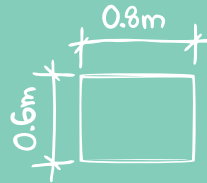

BX/HMP 400004

From £140



What time is it?

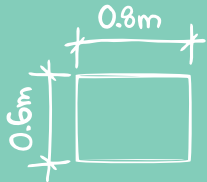

BX/HMP 400004

From £130

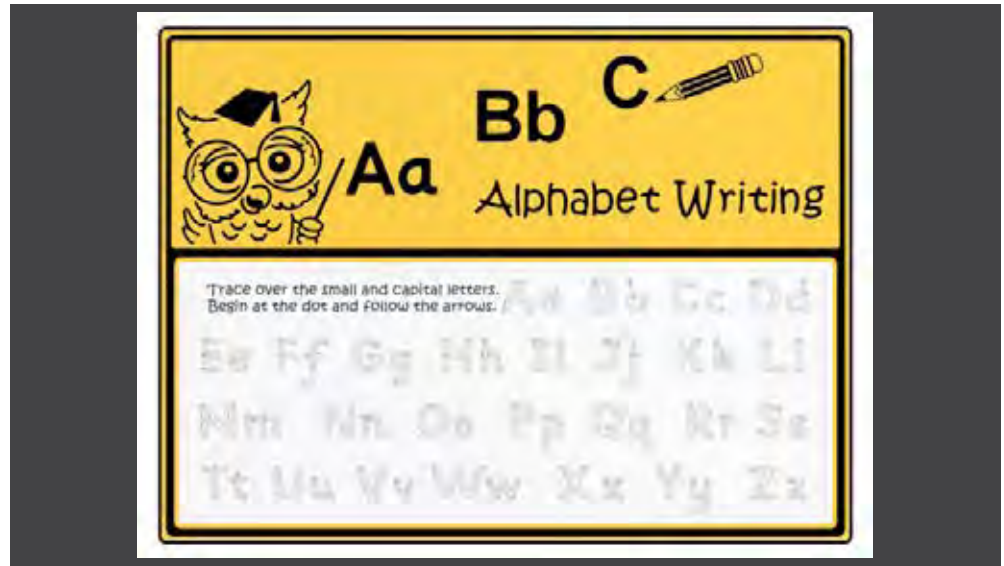

Alphabet Writing

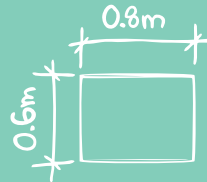

BX/HMP 400004

From £295



Butterfly  
Animal  
Face

Bespoke "Sparkes"  
Play Unit

Convex  
Mirror

Rain  
Wheel

**INCLUSIVE  
PLAY**

**DEVELOP  
STIMULATE  
INTEGRATE**

WANT EXPERT HELP WITH PLANNING  
YOUR SPACE? CALL US ON...

01420 474 111



# Wheelchair Accessibility



Chadsgrove School



West Acklam Clinic, Middlesbrough



Ysgol Y Gogarth, Llandudno



# Sensory Play



Hillside Specialist School

We can help you with your plans from DESIGN TO PLAY...  
Drop us a line to arrange your FREE consultation and design.  
tel: 01420 474 111 email: [info@handmadeplaces.co.uk](mailto:info@handmadeplaces.co.uk)

Bespoke sizes for gates and panels are naturally an option that we can also offer. Our archways provide a dramatic entrance to an outdoor space to help create the sense of entering a special place for the children to use and enjoy.



Stanton Bridge Primary School,  
Coventry



### 1m Single Gate



BX/HMP 600016  
Image shows 1m Single Picket Gate

From **£270**



### 2m Double Gate



BX/HMP 600017  
Image shows 2m Double Mouse & Cheese Gate

From **£360**



Lodsworth Recreation Ground

### 3m Double Gate



BX/HMP 600018  
Image shows 3m Double Bow Top Gate

From **£440**





Wembury Primary School,  
Devon

## Pencil Fence

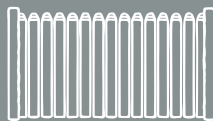

BX/PD 600002

Fence posts sold separately

From **£165** Per Metre



Holmgate Primary School,  
Chesterfield

## Picket Fence

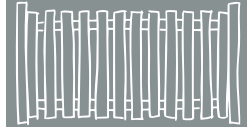

BX/HMP 600027

Fence posts sold separately

From **£80** Per Metre



Marlborough With South Huish Primary School

## Bow Top Fence



BX/HMP 600001

Fence posts sold separately

From **£110** Per Metre



Wharncliffe Side Primary School

### Wave Trellis Panel

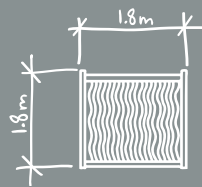

BX/HMP 600025  
Standard Bench not included

From **£325** Per Panel



Camps Hill Community Primary School,  
Stevenage

### Mouse & Cheese Fence

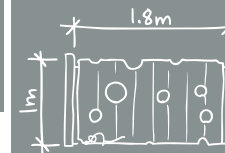

BX/HMP 600007  
Fence posts sold separately

From **£225** Per Panel



St Peters CE Primary School

### Piano Fence

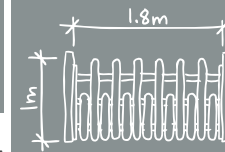

BX/HMP 600008  
Fence posts sold separately

From **£145** Per Panel



Keyworth Primary School

## Fortress Fence

BX/HMP 600002  
Fence posts sold separately

From **£225** Per Panel

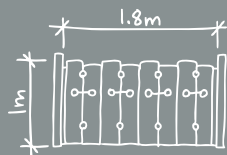

Blurton's Children's Centre

## Herringbone Fence

BX/HMP 600003  
Fence posts sold separately

From **£185** Per Panel

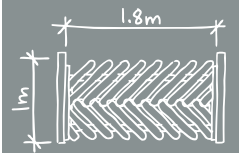

Blurton's Children's Centre

## Maze Fence

BX/HMP 600005  
Fence posts sold separately

From **£260** Per Panel

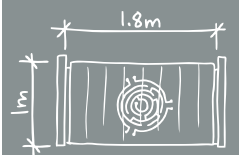



St Peters CE Primary School

## Hart Plain Gates

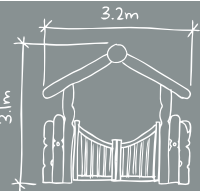

BX/HMP 600014

From **£1,895**



Lyng C of E Primary School,  
Norwich

## Pig on Gate

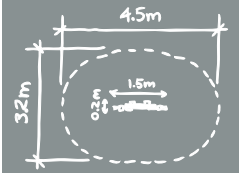

BX/HMP 350014

From **£625**



Steep C of E Primary School

## Steep Notice Board

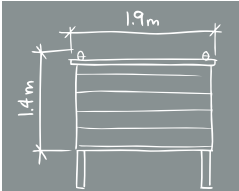

BX/HMP 750012

From **£POA**

Colebrook Junior School,  
Swindon



## Engraved Archway

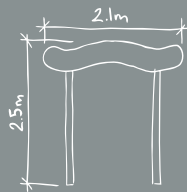

BX/HMP 750013

From **£905**

Hartside Primary School

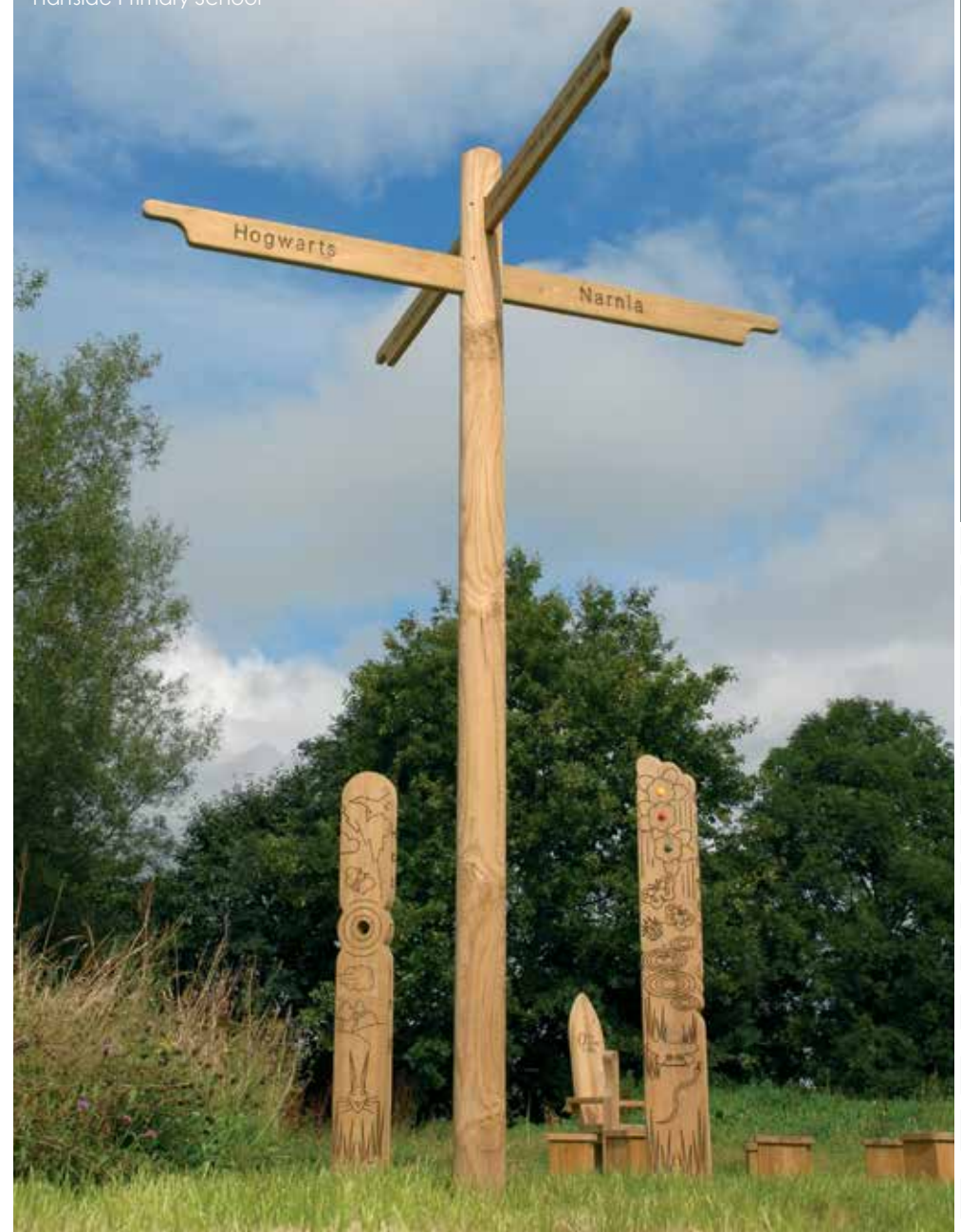

## 4 Way Finger Post

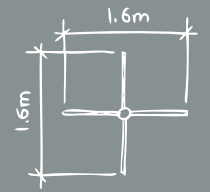

BX/HMP 750001

From **£295**



Roadway

Number Target

A-Z Dragon

1-10 Snake

Sports Pitch

Hexagon Hopscotch

# PLAYGROUND MARKINGS

## EXERCISE ENGAGE ROLE-PLAY

NOT QUITE SURE WHAT WILL WORK?  
CALL US FOR A FREE CONSULTATION NOW ON...

01420 474 111



# ROADWAYS AND CYCLE TRACKS

DESIGNED TO SUIT YOUR AVAILABLE SPACE, WE CAN ALSO ADD ZEBRA CROSSINGS, STOP SIGNS AND TRAFFIC LIGHTS.

BX/HMP MARKING

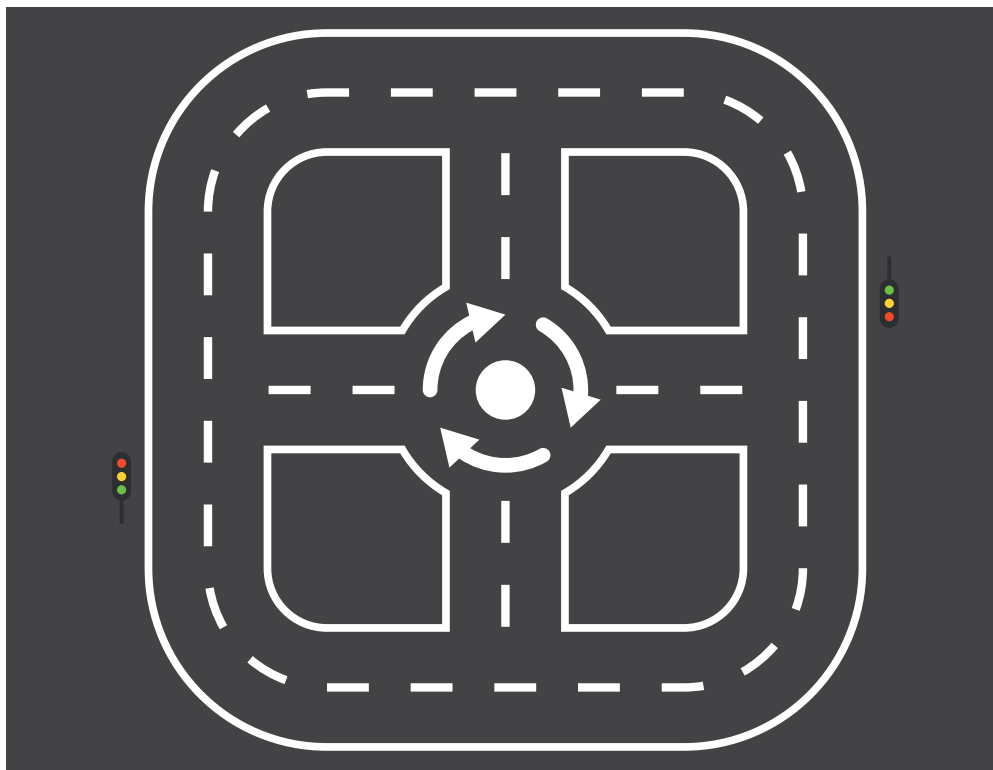

Car Park

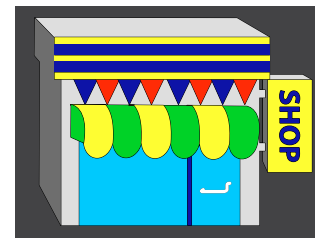

Shop

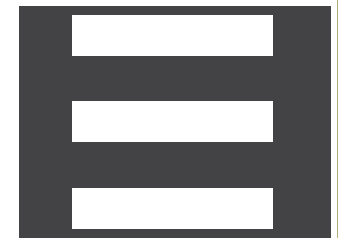

Zebra Crossing

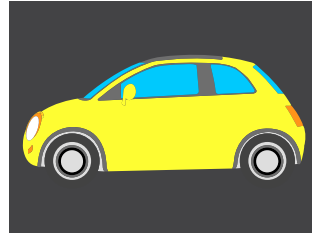

Car



One Way



School



House



Lollipop Lady

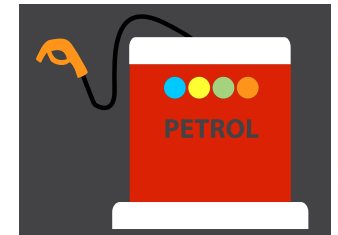

Petrol Pump

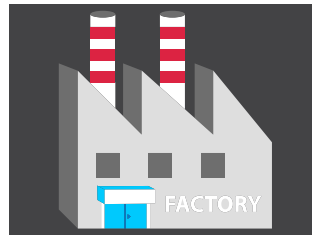

Factory



Stop Sign

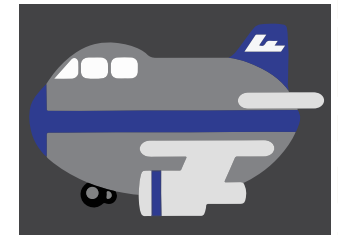

Plane



Give Way

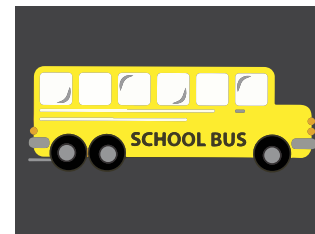

Bus

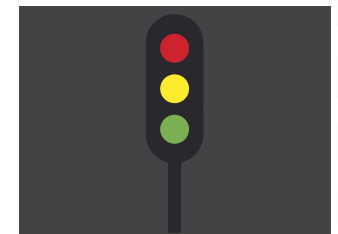

Traffic Light

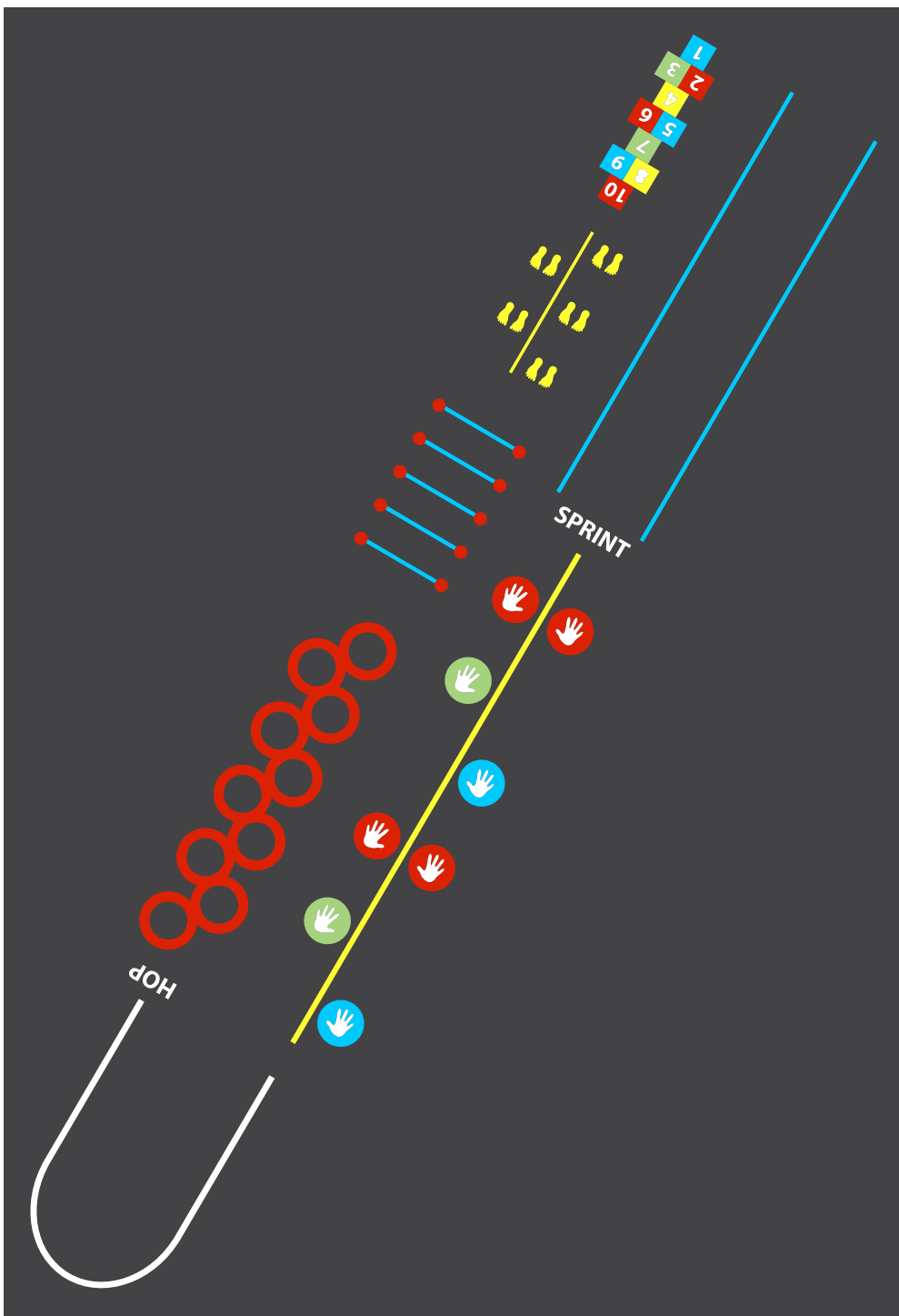

Fun Fitness Trail

BX/HMP MARKING

From £POA

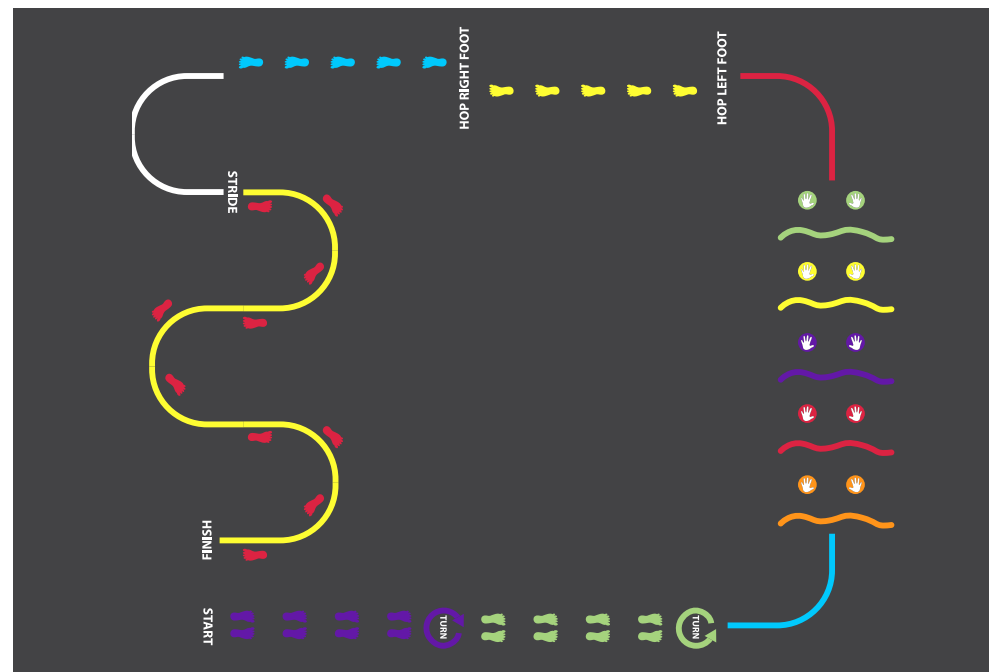

Activity Trail

BX/HMP MARKING

From £POA



1 - 10 Caterpillar

BX/HMP MARKING

From £POA



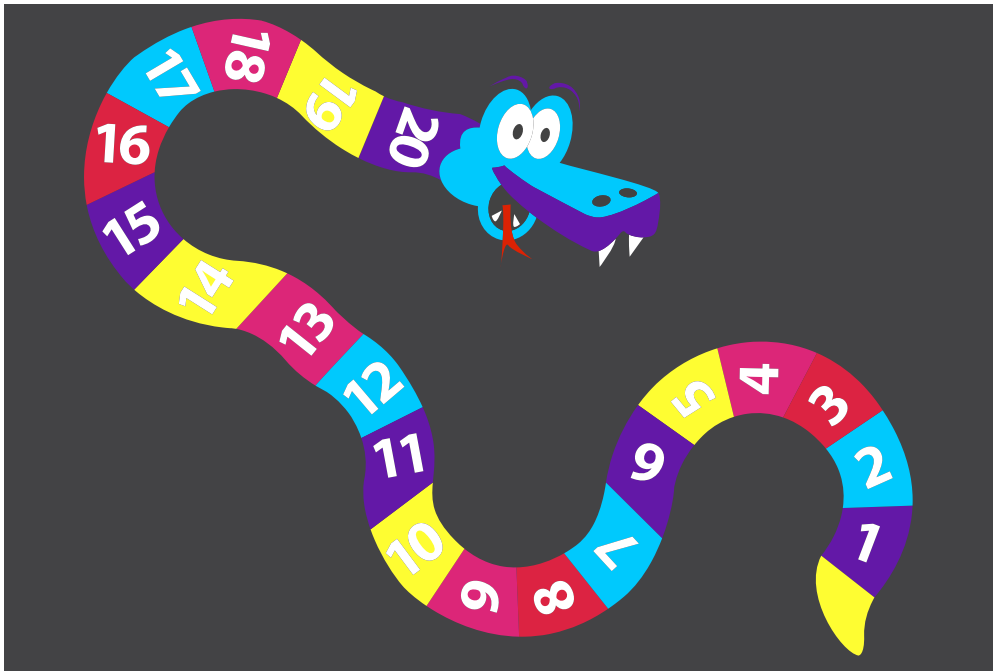

1 - 20 Snake  
BX/HMP MARKING

From £POA

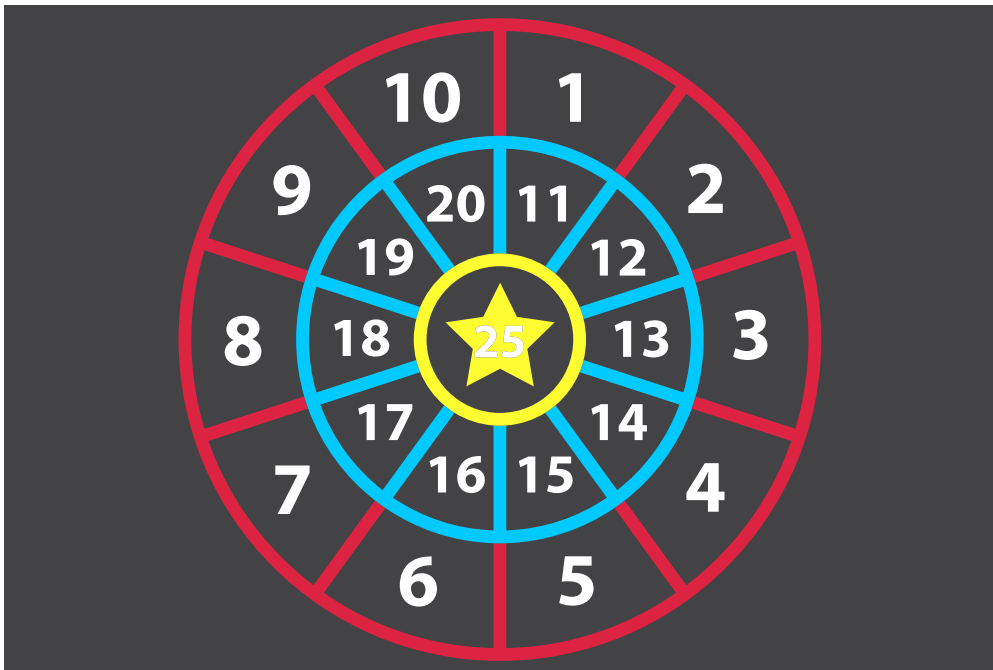

Number Target  
BX/HMP MARKING

From £POA

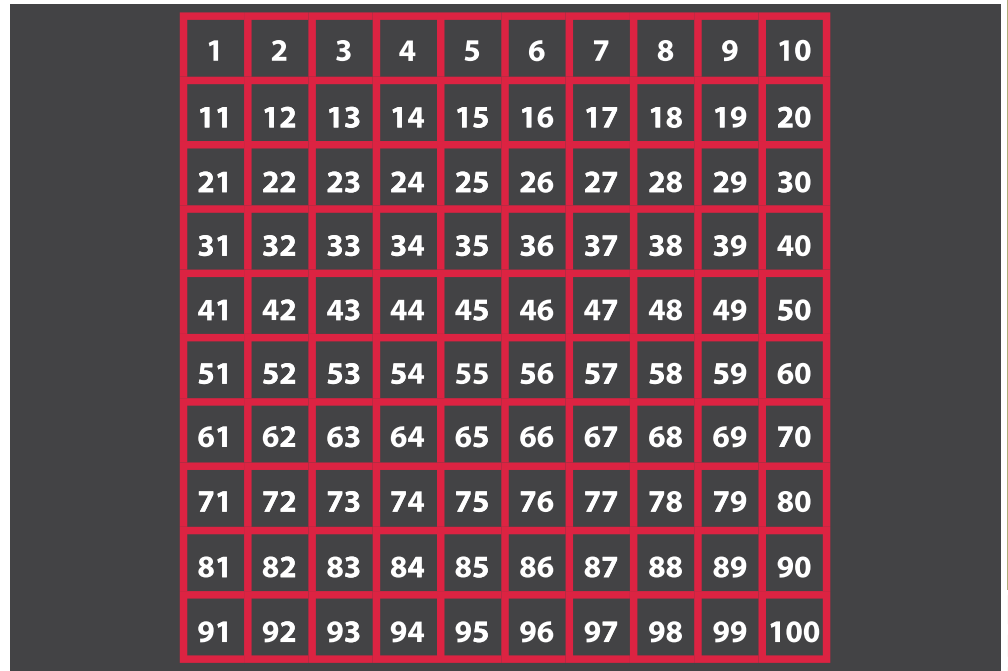

Number Grid Outline  
BX/HMP MARKING

From £POA

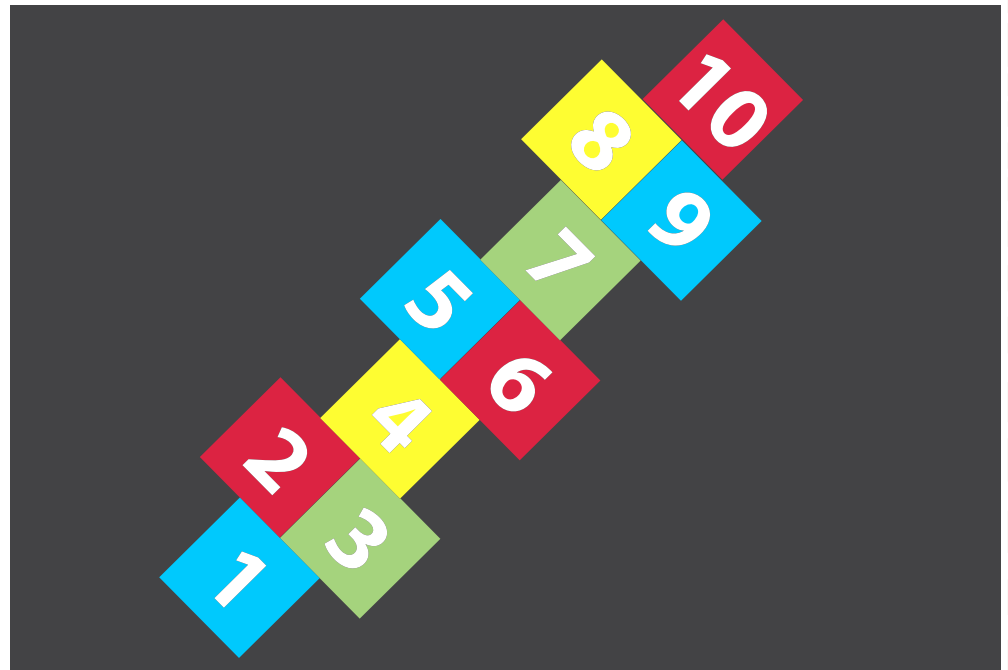

Hopscotch  
BX/HMP MARKING

From £POA

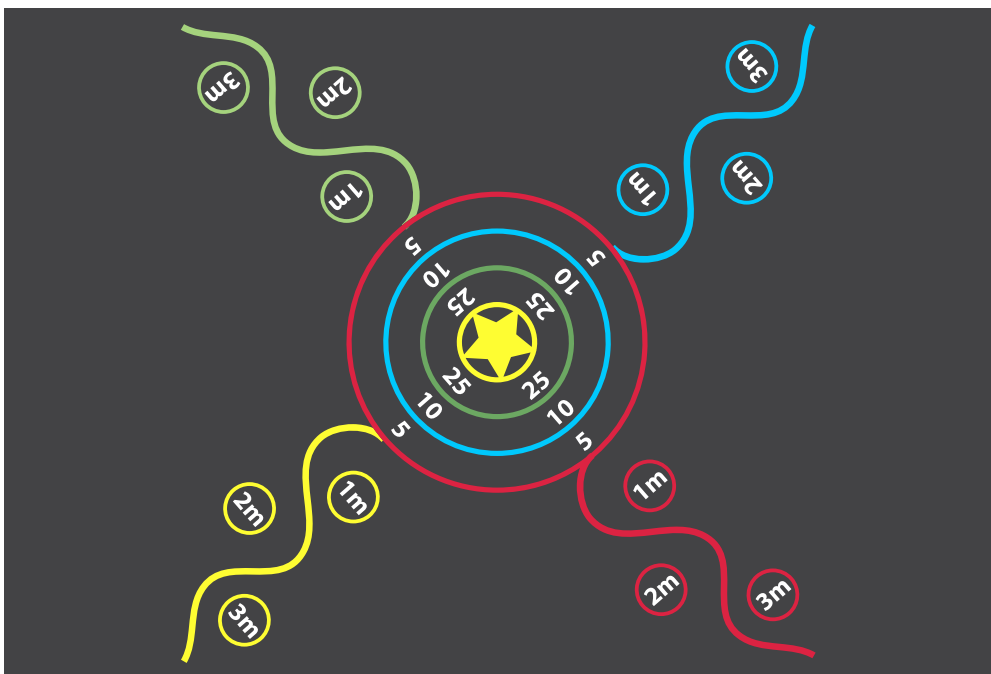

4 Way Target  
BX/HMP MARKING

From £POA

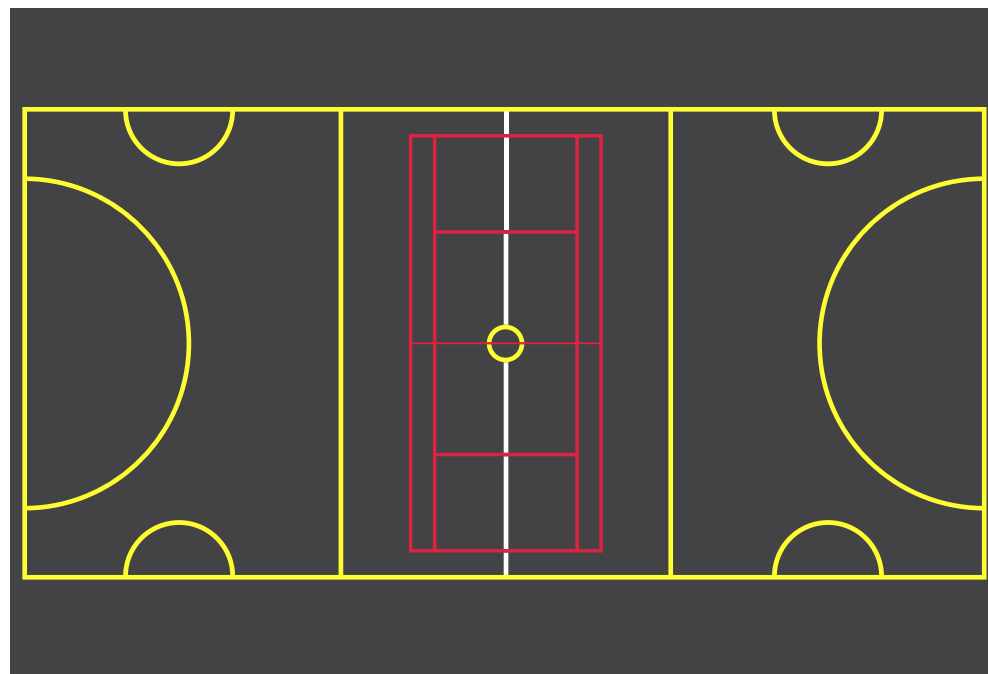

Multi Court  
BX/HMP MARKING

From £POA

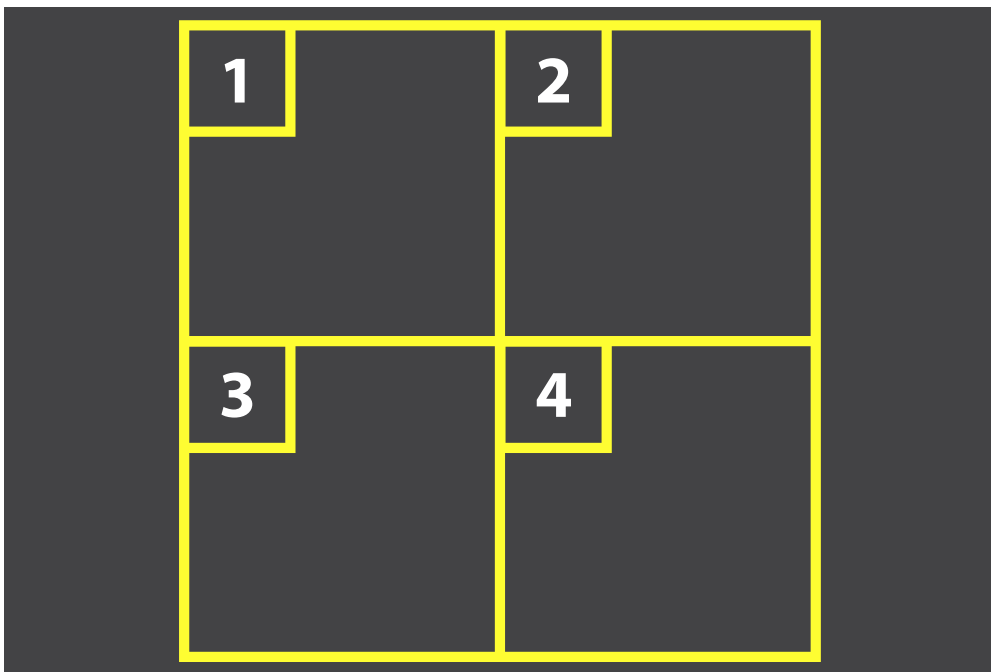

Four Square Game  
BX/HMP MARKING

From £POA



Alpha Shapes  
BX/HMP MARKING

From £POA



Mr Wolf

BX/HMP MARKING

From **£POA**



1 - 100 Snakes & Ladders

BX/HMP MARKING

From **£POA**

We've plenty more playground marking designs, so if you can't find what you want, get in touch...

tel: 01420 474 111  
[info@handmadeplaces.co.uk](mailto:info@handmadeplaces.co.uk)



A - Z Snail

BX/HMP MARKING

From **£POA**



Sprig

Sprout

timble

Early Years Equipment



WANT EXPERT HELP WITH PLANNING YOUR SPACE? CALL US ON...

01420 474 111



At Hand Made Places we are really proud to introduce to you our brand new EARLY YEARS RANGE. Inspired by its nimble features and timber construction, we named it TIMBLE...

**Twig**

- 1+
- 28.5 M<sup>2</sup>
- 0.4m
- 1m
- FSC

BX/HMP 300003

From **£3,850**

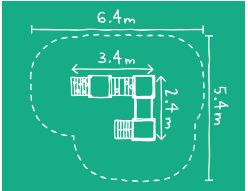

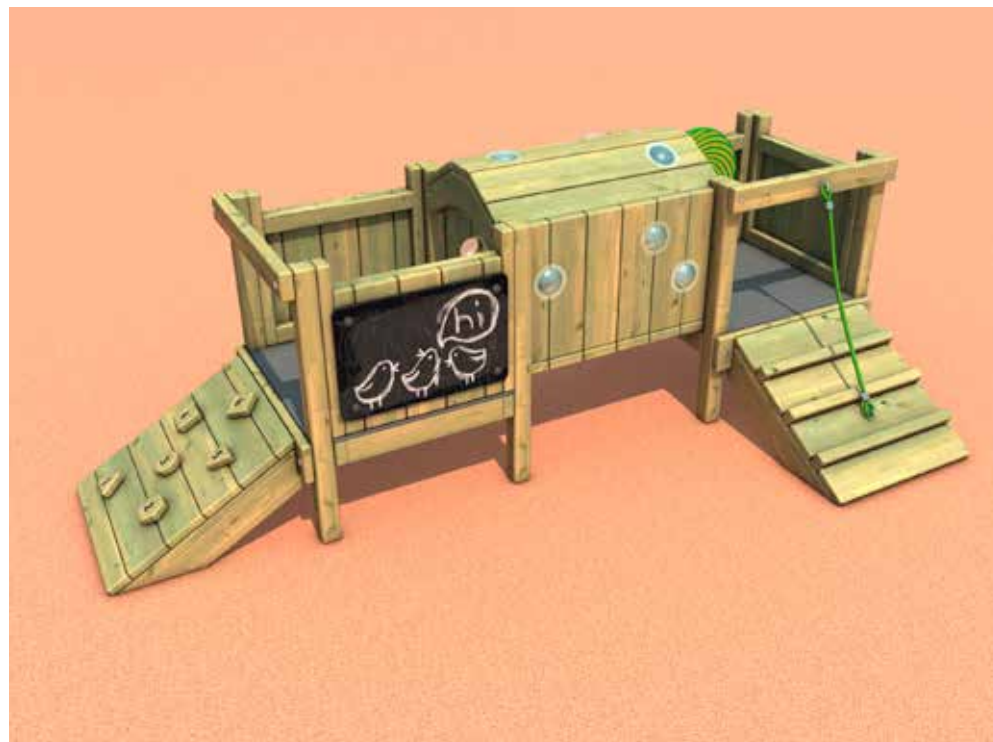
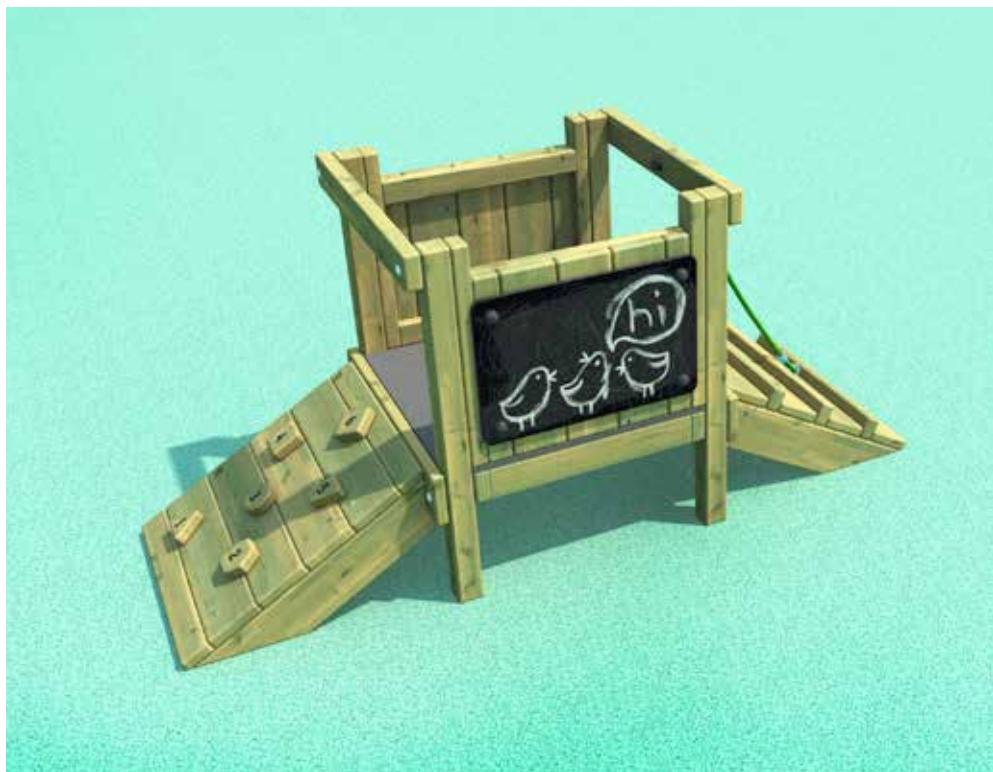

**Leaf**

1+ 17.2 M2 0.4m FSC

From **£1,295**

**Sprig**

1+ 22.9 M2 0.4m FSC

From **£2,595**



Crafted to be versatile and sturdy, TIMBLE units are easily assembled and built to last outdoors. Provided you have a level area with enough space, we have a TIMBLE unit to suit your play scheme.

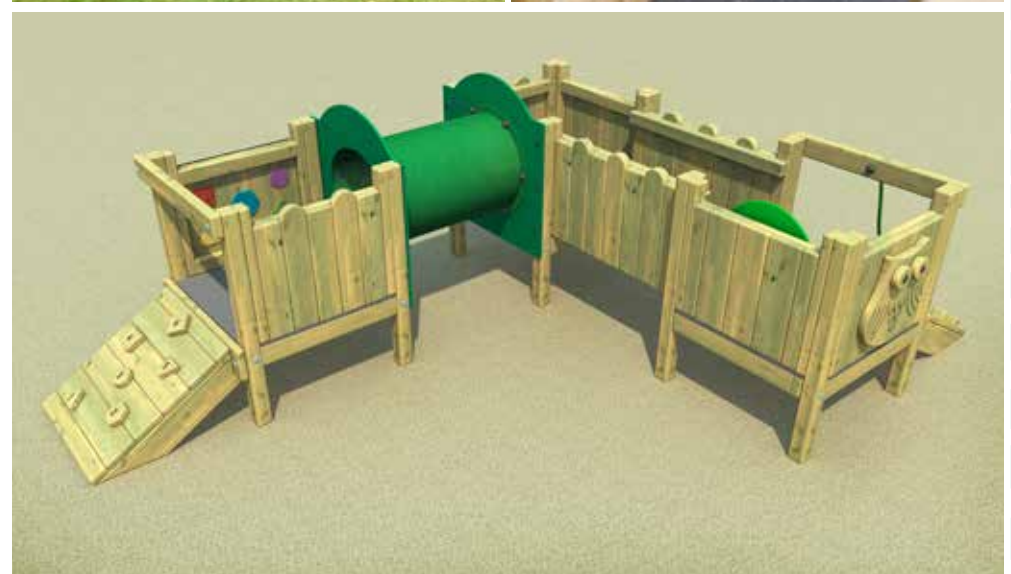

**Sprout**

BX/PD 300004 From **£2,995**

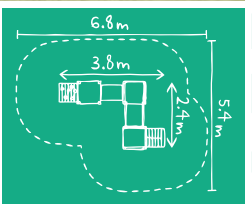



# Sunshine Gym

## Outdoor Fitness Equipment

a division of **broxap**

Sunshine Gym has designed a range of fitness equipment reduced in size for the intended user but constructed to the same quality standards of our adult range. This has proven to be popular with all children with varied sports abilities, encouraging enjoyable non-competitive physical activity and exercise.



### The benefits of Outdoor Fitness Equipment...

- Increasing young people's confidence and well-being along with improved concentration levels in the classroom.
- Encouraging young people to interact outside their normal social group, making new friends and developing social skills.
- Sunshine gym equipment can be used for compiling statistics for cross curriculum education in subjects such as maths and science.
- Equipment can allow all teachers with a non PE Background to conduct a challenging and enjoyable physical education lesson enjoyed by all participants.
- Pupil's physical progress can be easily monitored on categories such as balance, coordination, strength and flexibility.

[www.sunshinegym.co.uk](http://www.sunshinegym.co.uk)





The Children's Sky Stepper provides a workout for arms and legs as well as building strength, flexibility, balance and co-ordination.

## Children's Sky Stepper

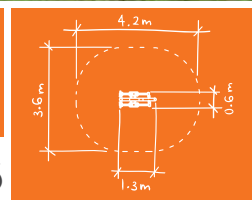

BX/SG 4009

From **£875**



Ideal for both balance and cardiovascular exercise, this unit can be used by two children at a time.

## Children's Double Slalom Skier



BX/SG 4006

From **£735**

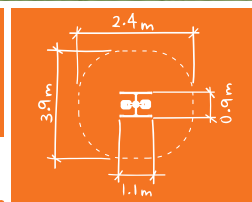



The Children's Waist Twister allows up to three children to workout at the same time. It also promotes flexibility and balance.

## Children's Waist Twister



BX/SG 4002

From **£779**

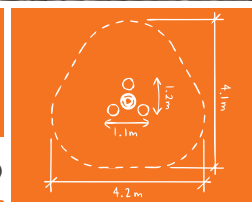



A much loved piece of equipment for children to have fun whilst exercising in a non-competitive environment. Let their imaginations run riot, thinking of the way that robots walk.

## Children's Double Health Walker



BX/SG 4005

From **£950**

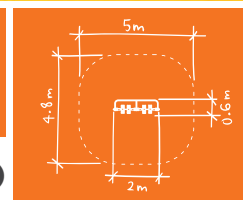



The Children's Double Sit Up Bench is a traditional item of outdoor gym equipment which has been in use for many years. It is designed with comfort in mind and is ideal for use by all age groups.

## Children's Double Sit Up Bench

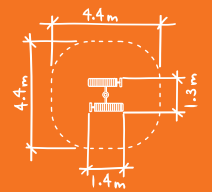

BX/SG 3001

From **£715**



The Children's Double Strength Challenger is one of our most popular pieces of outdoor fitness equipment. It provides a fun way to build up arm and shoulder muscle groups.

## Children's Double Strength Challenger

5+ 12 M2 0.6m 1m

BX/SG 4004

From **£452**

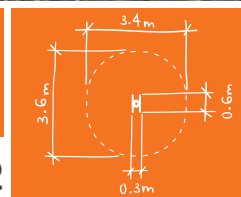



The Tai Chi Discs exercise the mind as well as arms and shoulders, and encourage social interaction.

## Children's Tai Chi Discs

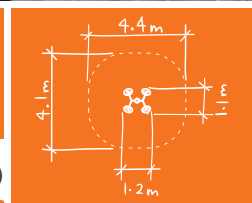

BX/SG 4010

From **£540**



The Children's Horse Rider provides a fun all body workout. Perfect for the school playground or park to encourage children to be active.

## Children's Horse Rider



BX/SG 4007

From **£526**

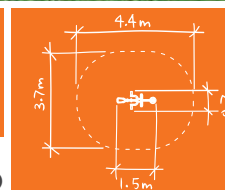





The Children's Arm & Pedal Bike is designed for use by all abilities. Ideal for use by children in KS1 & KS2. A great cardiovascular workout which also improves balance and co-ordination opportunities.

## Children's Arm & Pedal Bike

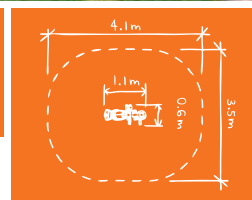

BX/SG 4011

From **£690**



The Children's Outdoor Rower can be used for a gentle warm up or for a more intense cardio workout.

## Children's Rower



BX/SG 4008

From **£825**

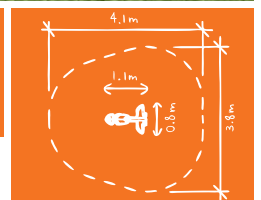



The Children's Leg Stretch helps to increase mobility in the hips. It can also be used for gentle squats when used as a handrail. It's great for warming up and encouraging good balance and greater flexibility.

## Children's Leg Stretch

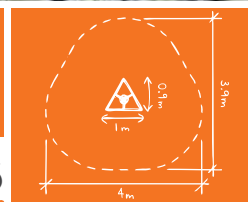

BX/SG 4003

From **£425**

King George Playing Fields,  
Chew Magna



Great Easton Recreation Ground,  
Leicestershire



# Lancaster West Estate Play Area, London



Monkton Elm Garden Centre,  
Somerset



# Queens Retail Park, Stafford





Appleby Magna Recreation Ground



Sandford Holiday Park,  
Poole, Dorset



Butchers Coppice Scout Camp,  
Bournemouth



# Paignton Zoo Environmental Park



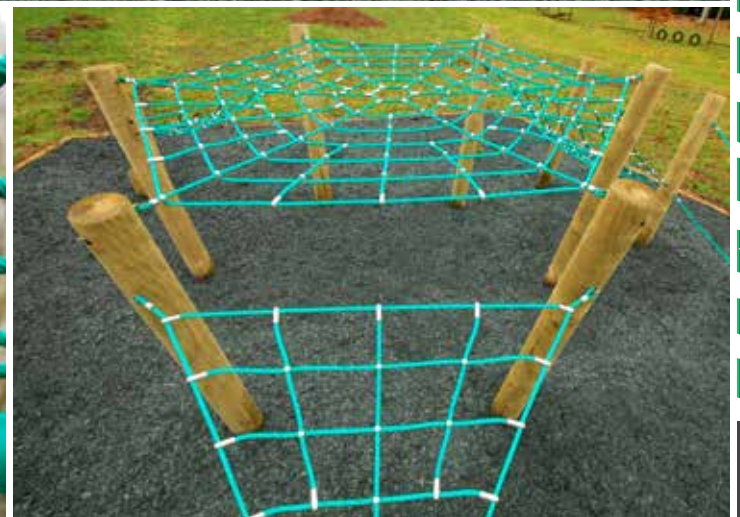

Holybourne Park,  
Alton, Hampshire



Dunham Park Scout Camp



# Miniature Pony Centre, Moretonhampstead, Devon







# St Teresa's Catholic Primary School



Eastfield Nursery School & Children's Centre,  
Wolverhampton



Thorn Grove Primary School



Maple Court Academy



Vickerstown Primary School,  
Barrow-in-Furness, Cumbria



Rowan Preparatory School,  
Esher, Surrey



# St Mary & All Saints CE Primary School







Houndsfield Primary School,  
Edmonton, London



Houndsfield Primary School,  
Edmonton, London



# The James Cook Hospital

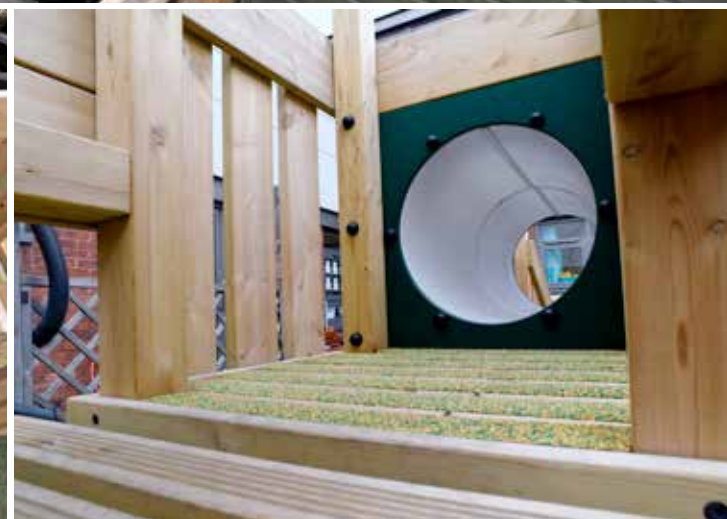
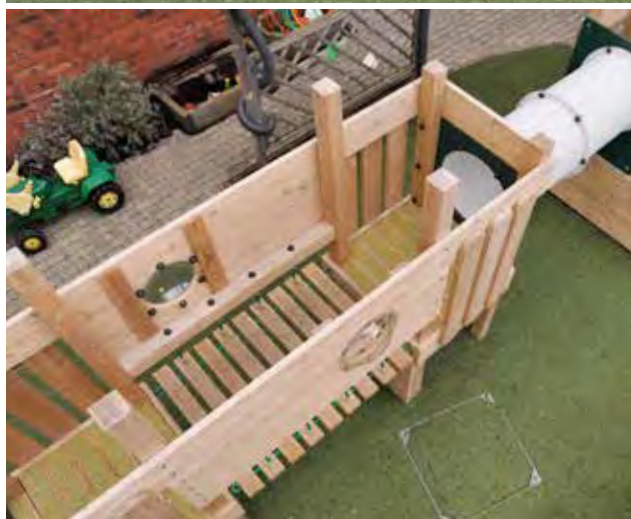

Hermitage Primary School,  
Dunbartonshire



Alvaston Park,  
Derby

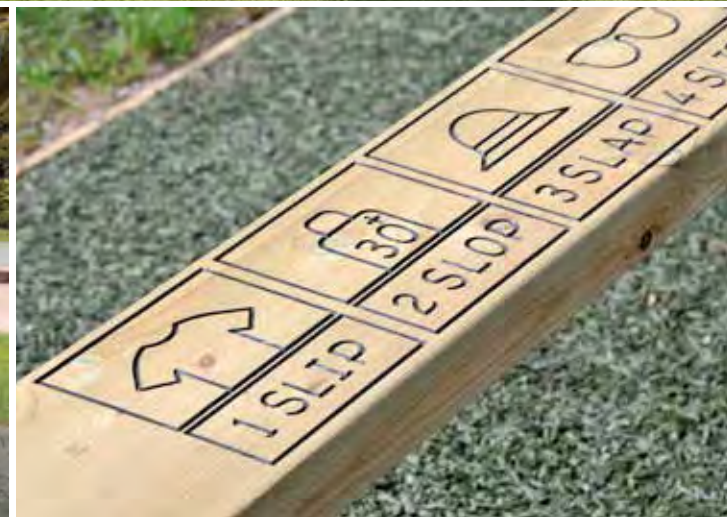

Stebdon Primary School,  
London



# DESIGN YOUR OWN

We've compiled some of our most popular products for you to try your hand at being a PLAYGROUND DESIGNER! Simply follow these instructions to bring your own project to life!

You can find these pages and more on our website...

[www.handmadeplaces.co.uk//resources](http://www.handmadeplaces.co.uk//resources)

Before you start, you'll need the following items.  
Printer or photocopier for more copies, scissors, glue, plain paper, colouring pens or pencils and some REALLY COOL IDEAS!

**STEP 1:**  
Photocopy the following pages.

**STEP 2:**  
Cut out the playground equipment pictures.

**STEP 3:**  
Arrange and stick them down with glue onto a plain piece of paper.

**STEP 4:**  
Colour in around the playground equipment with your favourite theme. It could be a Jungle, outer space or even the deep sea...







Why not share your playground design with us?

 [facebook.com/handmadeplaces](https://www.facebook.com/handmadeplaces)

 [@Handmadeplaces](https://twitter.com/Handmadeplaces)

To download all these pages and more, visit...  
[www.handmadeplaces.co.uk//resources](http://www.handmadeplaces.co.uk//resources)

Carefully, cut along the dashed lines with scissors.

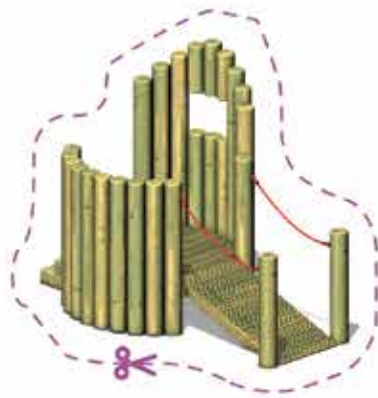

Lighthouse

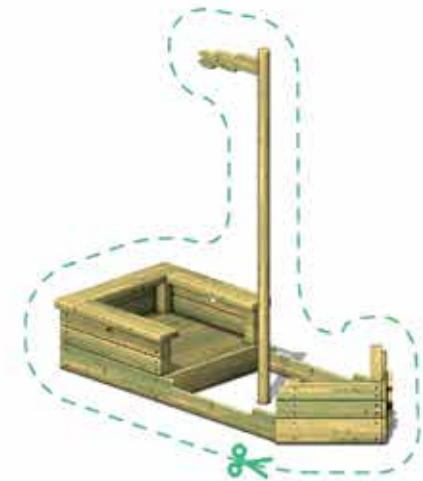
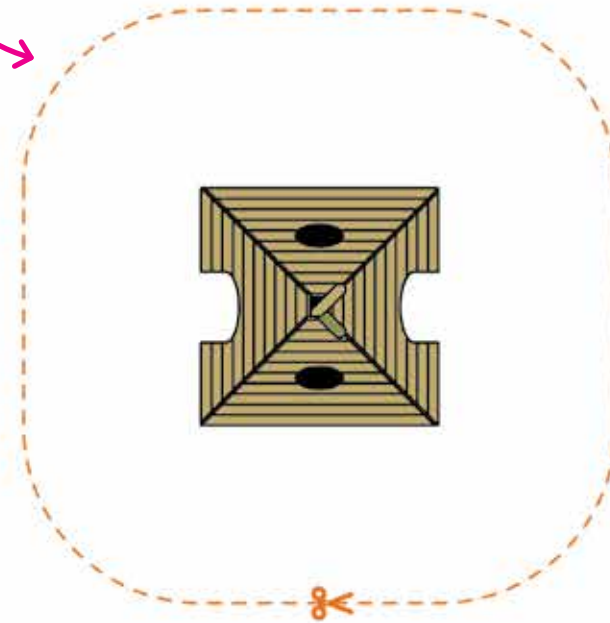

Play Boat

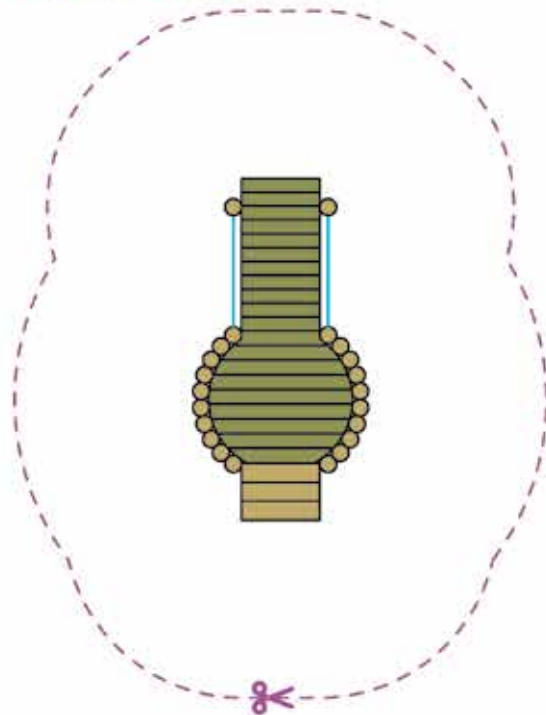

Teepee

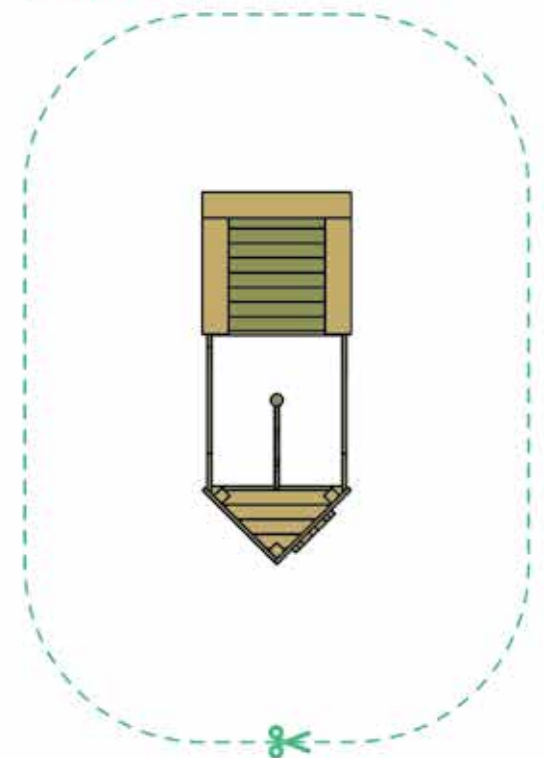



Dragonfly

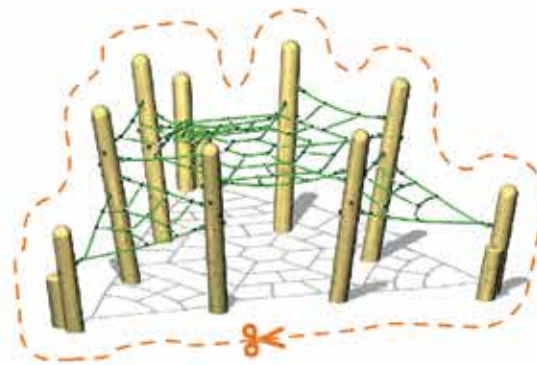
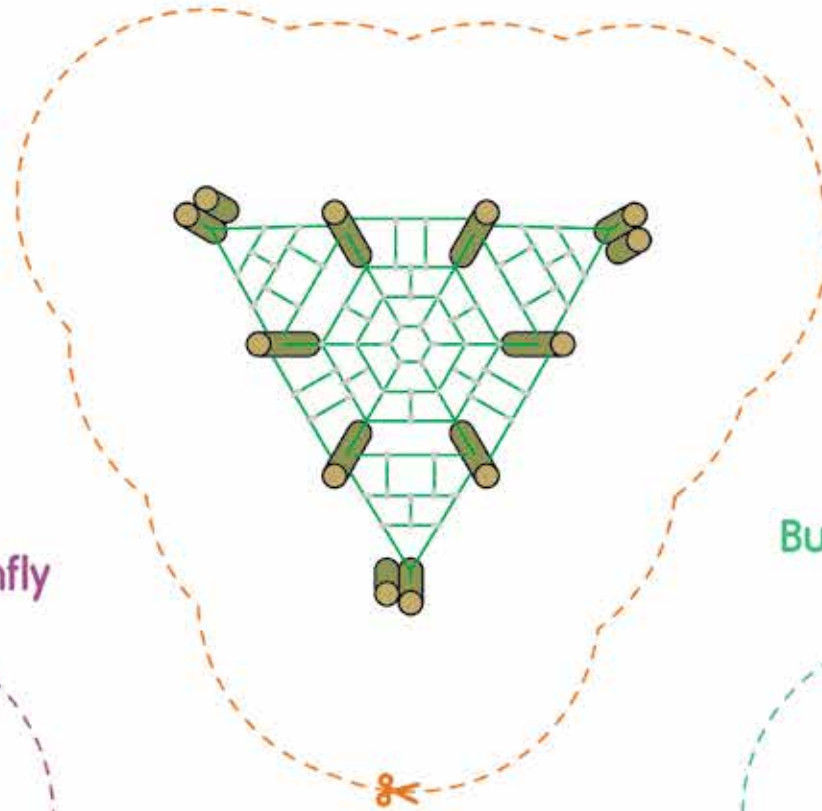
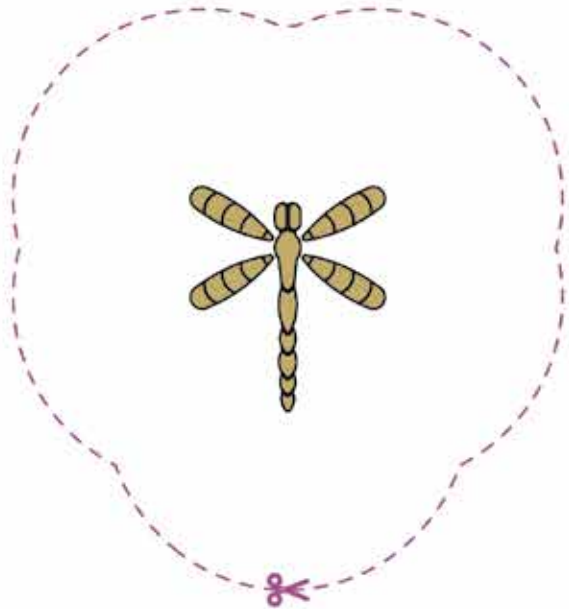

Amazon Rope Climber



Butterfly

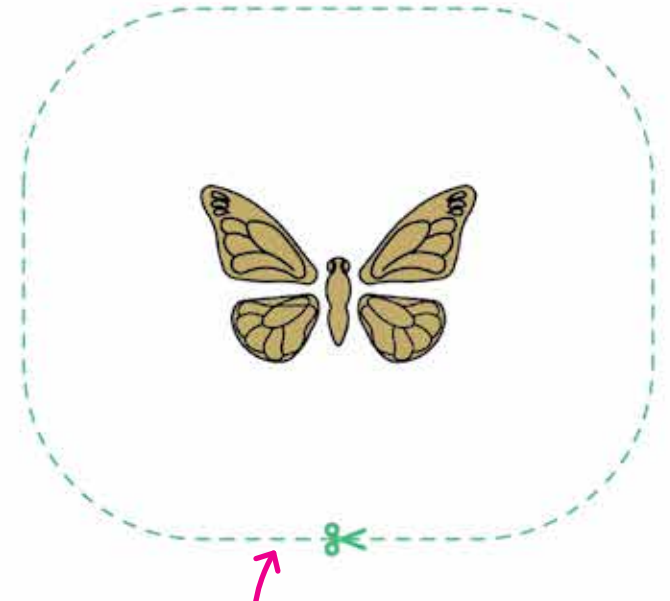

These lines are for safety, so shouldn't overlap with any other items

Clatter Bridge

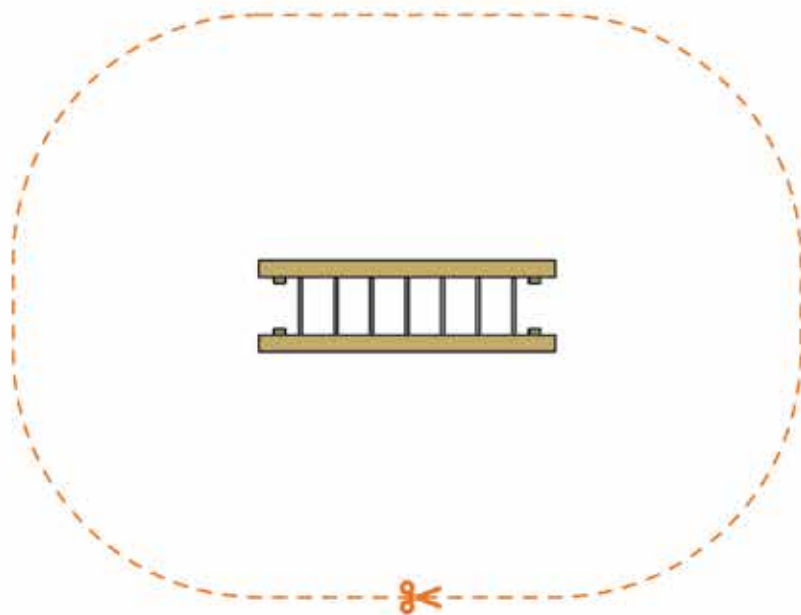

Double Traverse Wall

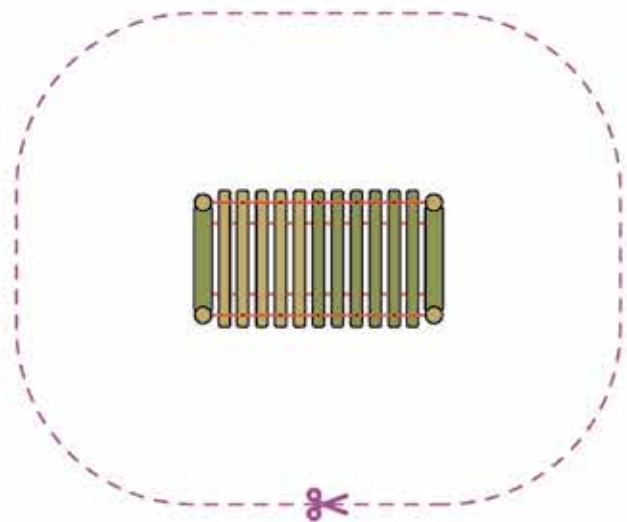
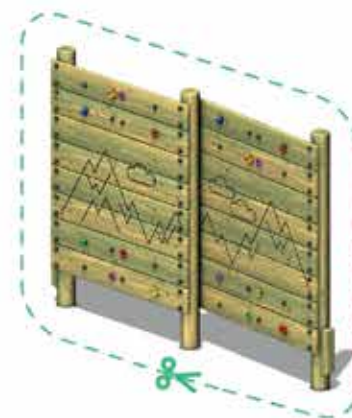

Overhead Ladder

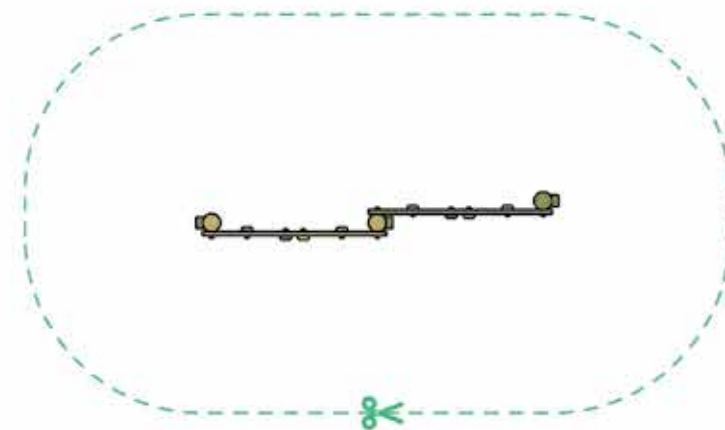

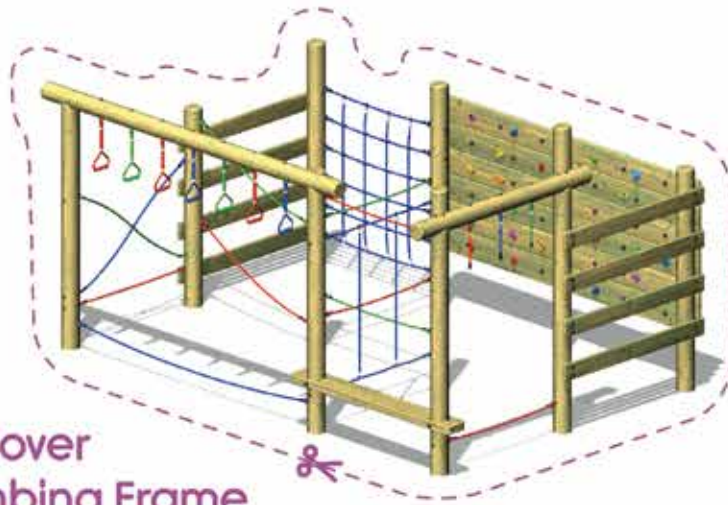
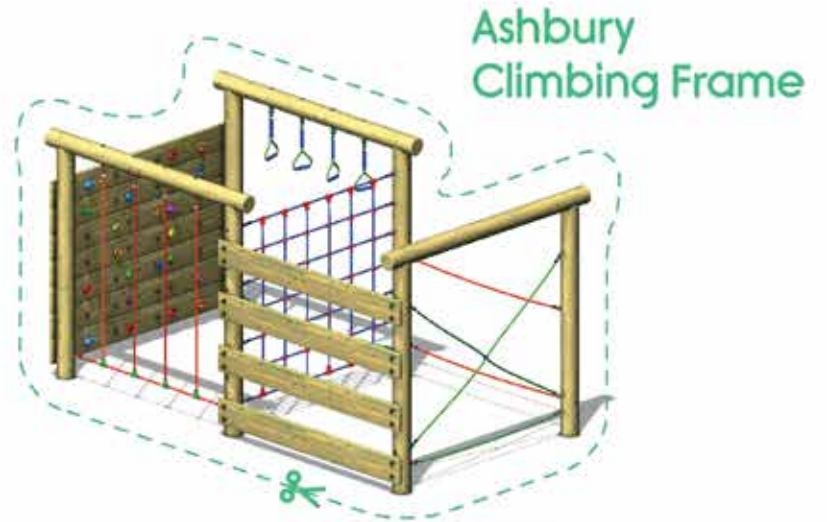
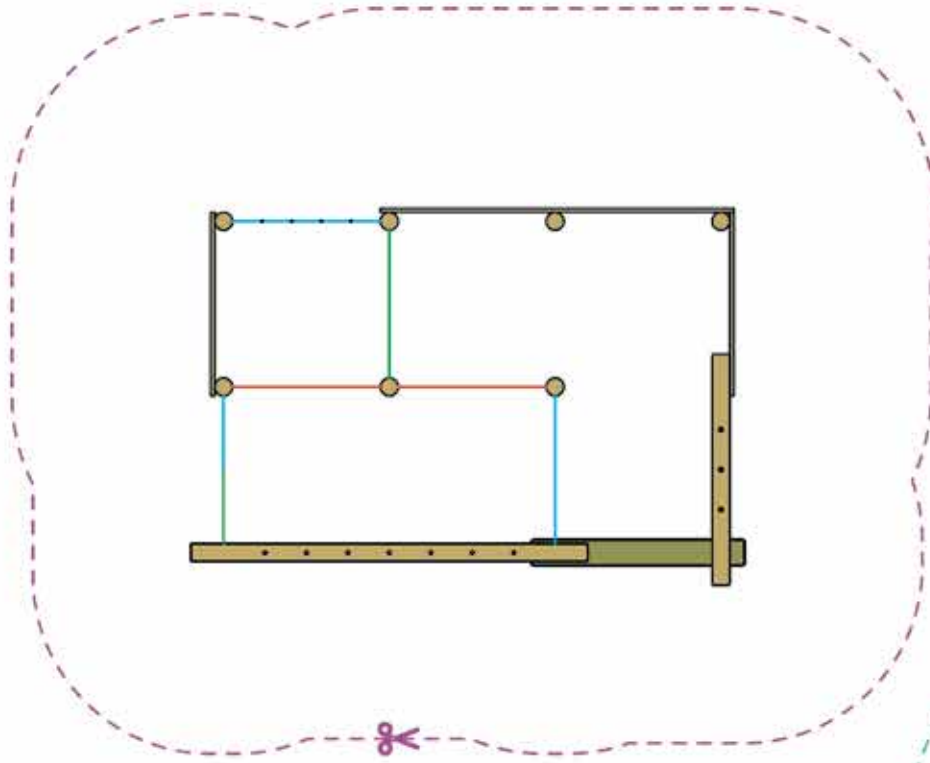

Andover Climbing Frame

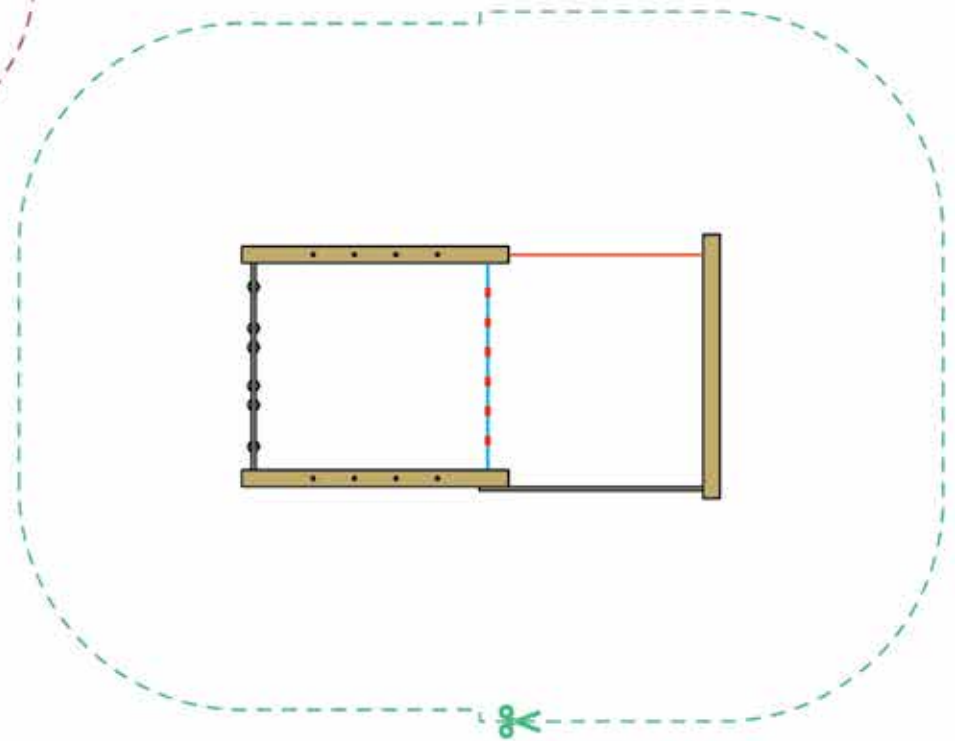

Chin Up

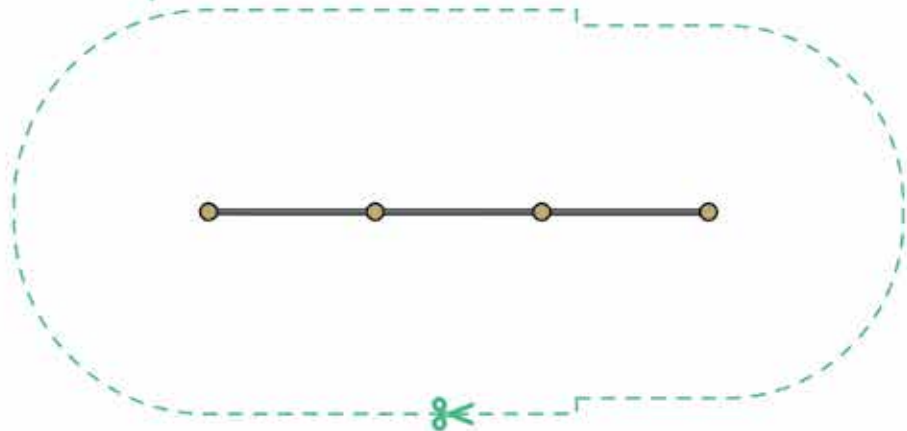

Swing Steps

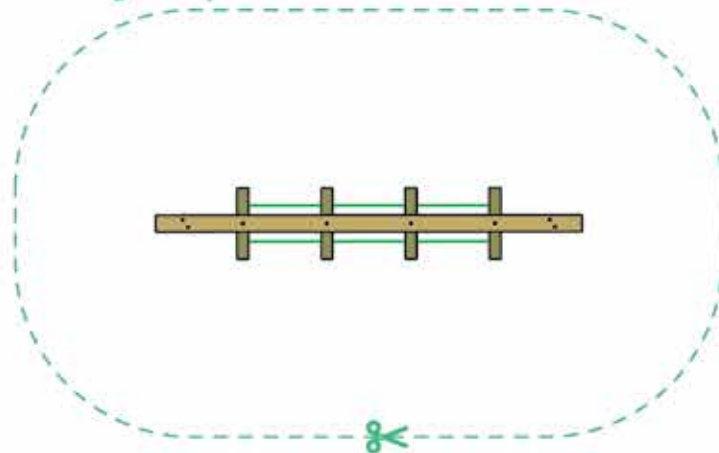

Balance Beam

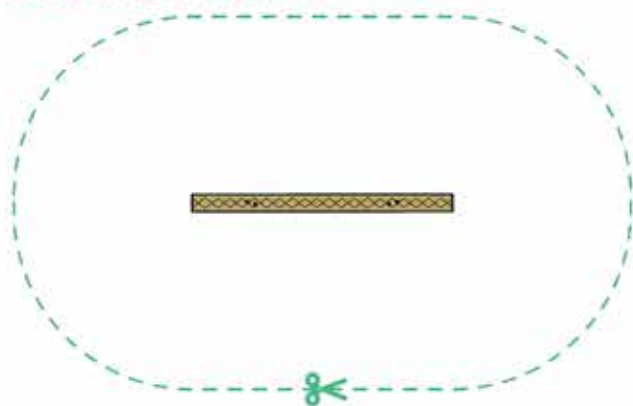

Rope Walk

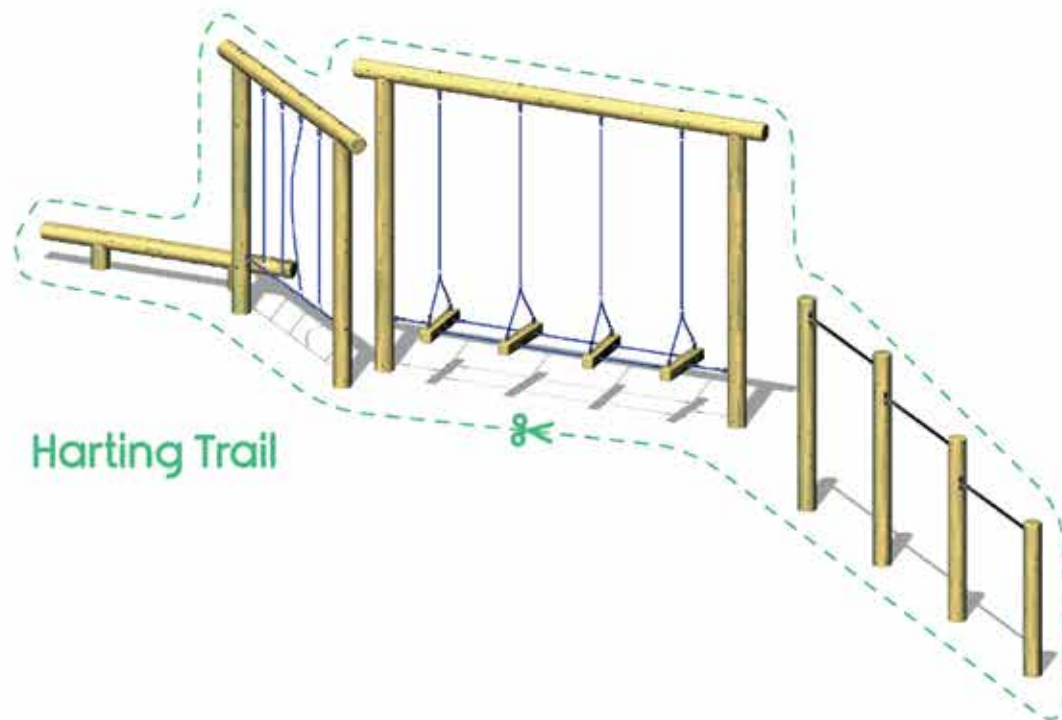
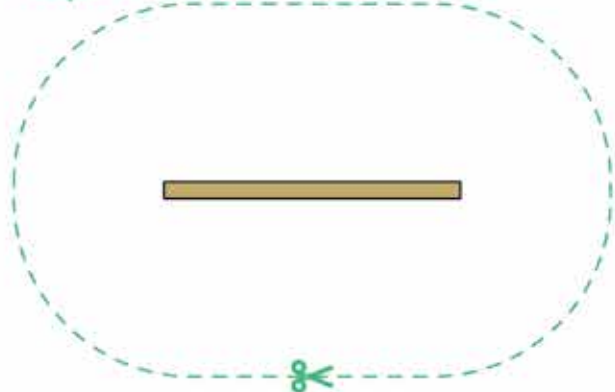

Harting Trail

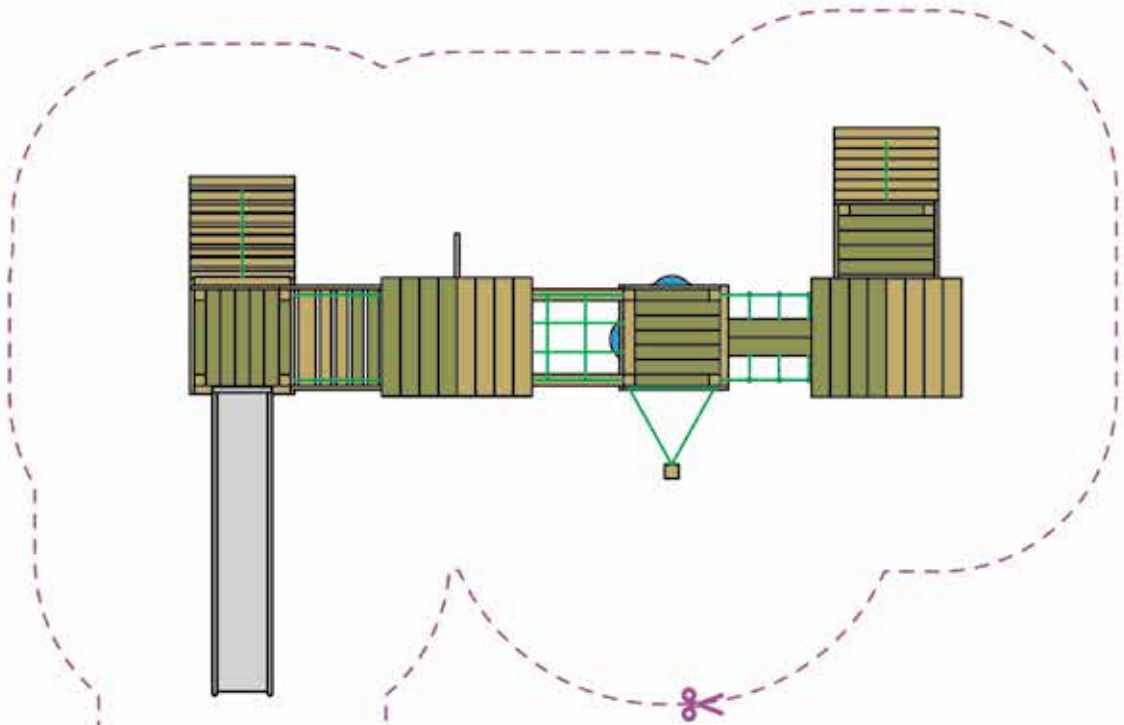

Manor Play Unit

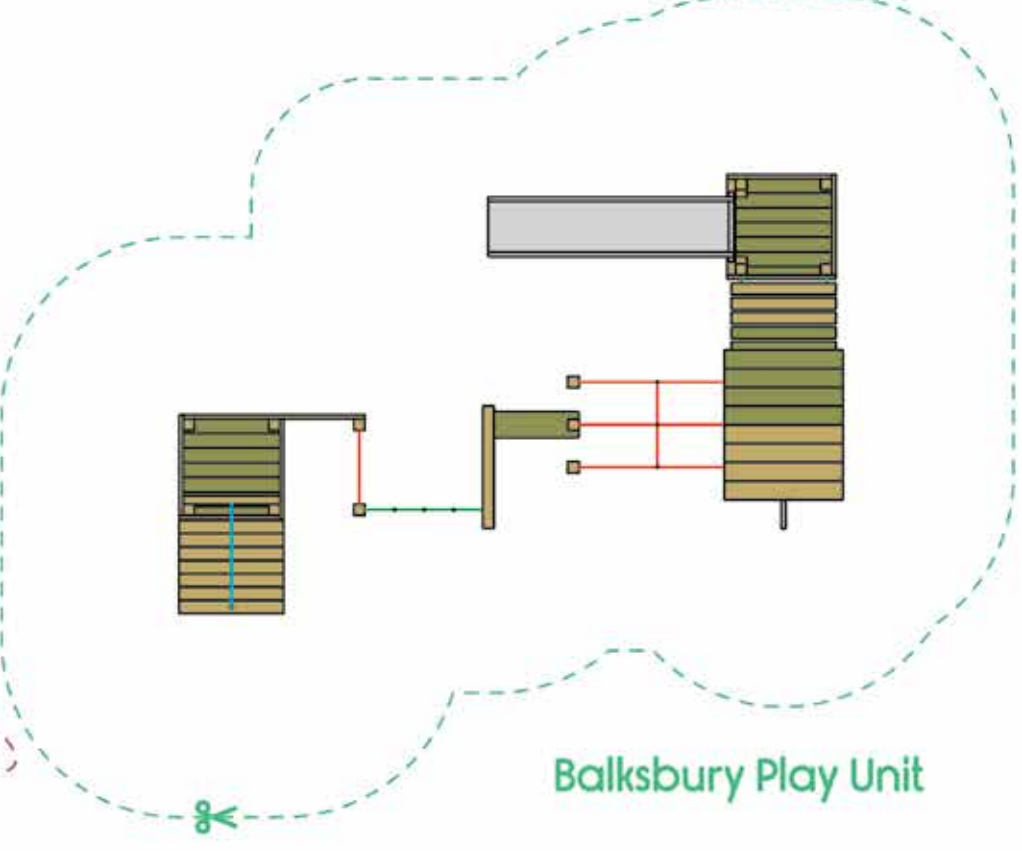
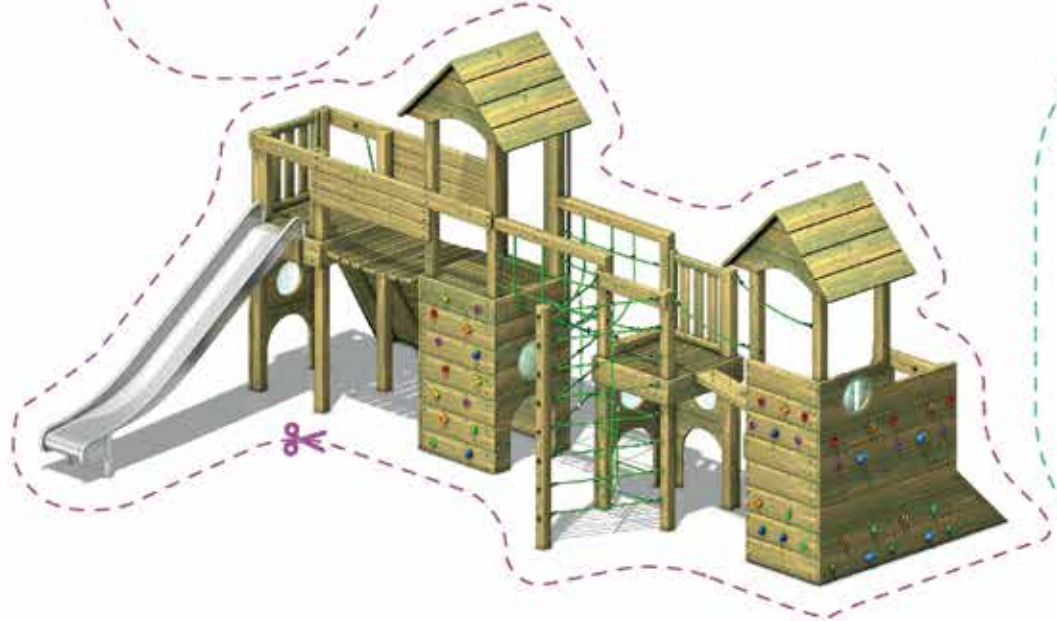
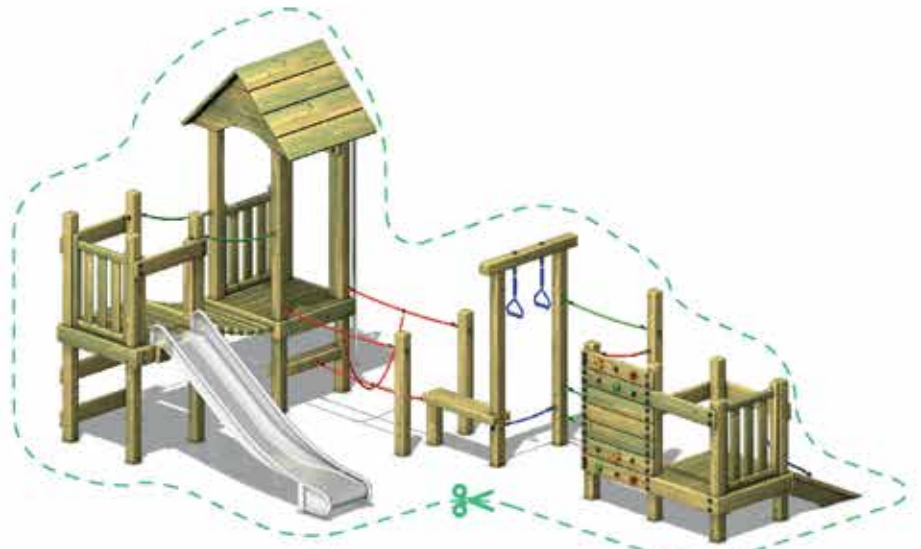

Balksbury Play Unit



# broxap

Broxap is a family owned business, founded 1946, specialising in the design and manufacture of high specification street furniture, all types of shelters, design & build projects plus sports and play equipment. Their factories and workshops are based across the UK manufacturing a range of products from Steel Shelters to Sports Netting. Broxap's purpose is to supply high specification products which will endure a long, safe life. Our goal is to supply these products to every city, town, village and rural area throughout the UK.



Brownedge St. Mary's Catholic High School, Lancashire

## Shelters

Canopies, Walkways, Fabric Structures, Kennels, Design & Build bespoke service

Marlowes Shopping Precinct,  
Hemel Hempstead



## Design & Build

Imagine, design & build... canopy, shelter and covered walkway architectural engineering solutions

Compass House,  
Cambridge



## Cycle Parking

Cycle Stands, Racks, Shelters and Hubs





Blyth Bus Station



Mary Stevens Park,  
Stourbridge



The Portsmouth School



Velodrome, Derby



K.C. Stadium, Hull City A.F.C.

## Street Furniture

Bollards, Seating, Post & Rail, Signage, Planters and Litter Bins

## Sports Equipment

Cloak & Changing Rooms, Netting, Athletics Equipment



THANKS FOR LOOKING

Remember to book your FREE playground consultation.  
Call us now on: **01420 474 111** or email: **info@handmadeplaces.co.uk**

We love wood! Our timber comes from managed forests and is all FSC certified, the majority of it being laminated European redwood. Using laminated timber increases the strength of our products as well as making them resilient and much less likely to crack, warp or deform as single piece timbers.

\*Further terms, conditions and other qualifications apply.  
Please visit [www.handmadeplaces.co.uk](http://www.handmadeplaces.co.uk) for details.

For more info, visit...  
[www.handmadeplaces.co.uk](http://www.handmadeplaces.co.uk)





# Hand Made Places

a division of **broxap**

Northern Sales Office  
Rowhurst Industrial Estate,  
Chesterton,  
Newcastle-under-Lyme, ST5 6BD  
tel: 01782 564411

Southern Sales Office  
Unit 1 Bordon Trading Estate  
Old Station Way, Bordon  
Hampshire, GU35 9HH  
tel: 01420 474 111

Welsh Sales Office  
Regus House, Malthouse Avenue,  
Cardiff Gate Business Park,  
Cardiff, Mid Glamorgan, CF23 8RU  
tel: 02920 118391

[www.handmadeplaces.co.uk](http://www.handmadeplaces.co.uk)

[info@handmadeplaces.co.uk](mailto:info@handmadeplaces.co.uk)

fax: 01420 474 222



 [facebook.com/handmadeplaces](https://facebook.com/handmadeplaces)

 [@Handmadeplaces](https://twitter.com/Handmadeplaces)



Please recycle me