



# INSPIRA

modular planting system



# INSPIRA

modular planting system

**Inspira** is a flexible, modular retaining wall system, perfect for creating raised planting schemes in any location.

The ease of installation makes **Inspira** a quick and cost-effective addition to street, courtyard and roof terrace developments.

**Inspira** is available in a wide variety of materials, finishes and sizes to meet the requirements of any site.

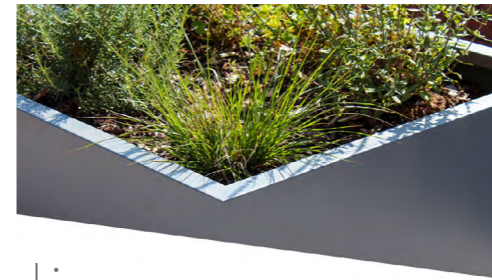

linear



form



bespoke

# INSPIRA<sub>linear</sub>

**Inspira Linear** is a collection of straight walls and angled corners, designed for geometrically-shaped installations (squares, rectangles, parallelograms, triangles etc.)



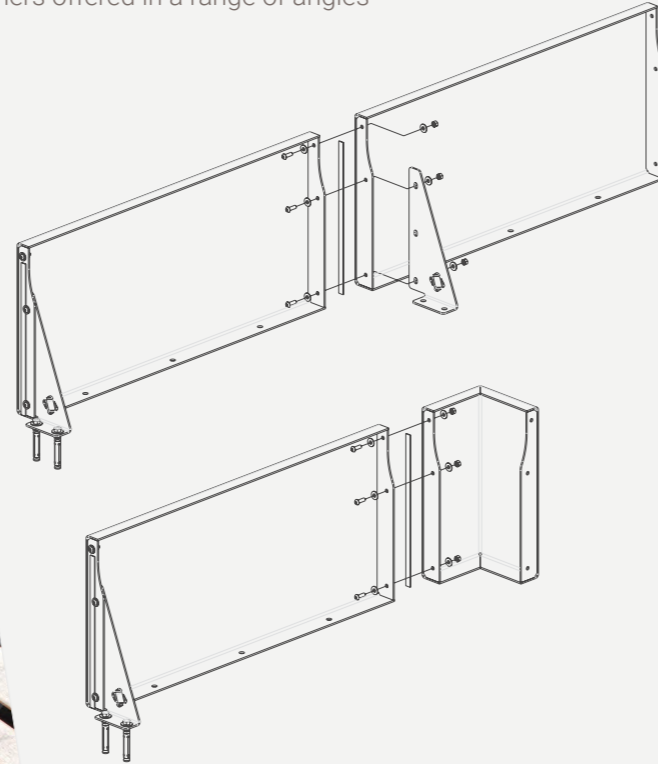

**Linear** can also function as a low-cost alternative to complex curved schemes, using its variety of angled connectors to match design intent.

Distinctive features of **Inspira Linear**:

- 4mm Corten weathering / powder coated / stainless steel construction throughout.
- Folded edge - 40mm return at top, visible face - 60mm return at base
- Corners offered in a range of angles

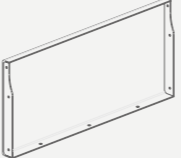

## INSPIRA COMPONENTS **Linear**

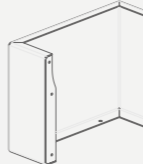
		Lengths (mm)	Heights (mm)	Angles (°)
Straight		1000, 1200, 2000	450, 600	
External Corner		1000, 1200, 2000	450, 600	45, 60, 90, 120, 135
Internal Corner		1000, 1200, 2000	450, 600	45, 60, 90, 120, 135
End Return		1000, 1200, 2000	450, 600	45, 60, 90, 120, 135

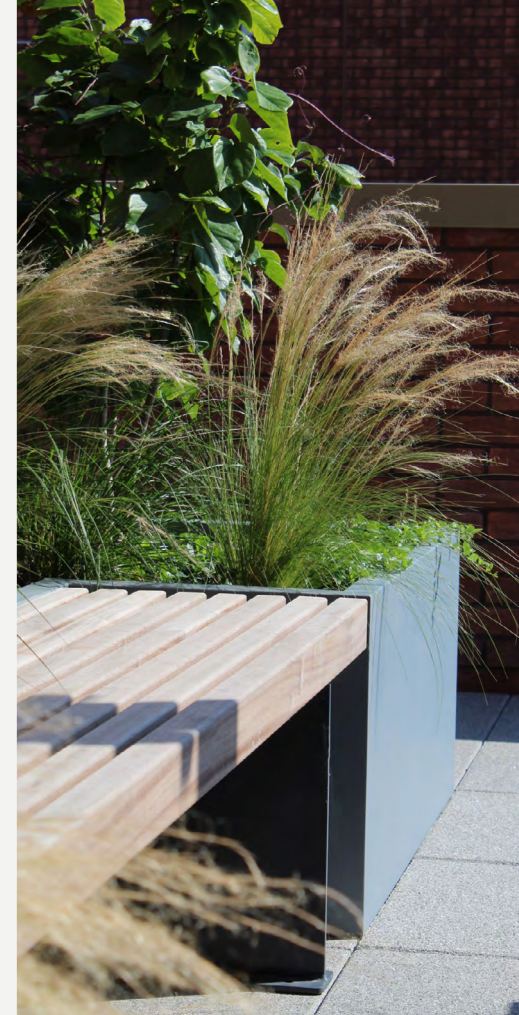

[Click here to view product page](#)

# INSPIRA<sub>form</sub>

**Form** includes all the rectilinear components of **Linear** with the addition of curved wall and corner sections, allowing more organically shaped installations (circles, lozenges, waves etc.)

Components of **Form** have a thicker wall to allow its slim profile and minimal visual impact at the top edge.



Distinctive features of **Inspira Form**:

- 6mm Corten weathering / powder coated / stainless steel construction throughout.
- Curved panels available in over 40 configurations.
- Visible 6mm edge for minimalist finish.
- Curved corners offered in a range of angles.

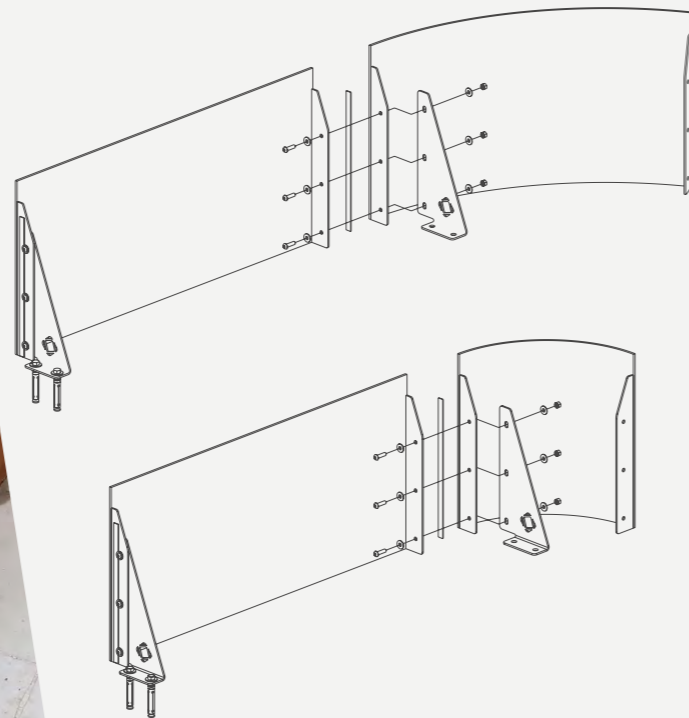

## INSPIRA COMPONENTS **Form**

		Lengths(l)/radii(r) (mm)	Heights (mm)	Angles (°)
Straight		1000, 1200, 2000 (l)	450, 600	
Curve		800,1200,1400, 1600,1800 (r)	450, 600	45, 60, 90, 120, 135
Curved Corner		300 (r)	450, 600	45, 60, 90, 120, 135
Straight Corner		200x200 (l)	450, 600	45, 60, 90, 120, 135
End Return		600x200x200 (l)	450, 600	45, 60, 90, 120, 135



[Click here to view product page](#)

# INSPIRA bespoke

Bailey Streetscene have completed a number of bespoke projects using the **Inspira** installation methodology.







These projects form a basis of knowledge and experience, from which to continually improve upon our bespoke offering.



## WHY BAILEY

For us, **Inspira** is a service, not just a product.

We'll support you during your initial design phase through to installation, handover and beyond.

-  **30 + years industry experience**
-  **Dedicated design team**
-  **Site consultation / survey**
-  **Delivery & logistics**
-  **Installation**
-  **Aftercare**
-  **Coordinated street furniture packages**

## INSPIRA

### **Integrated Products:**

*Connectivity & Charging, Waste Management, Privacy Screening, Lighting.*

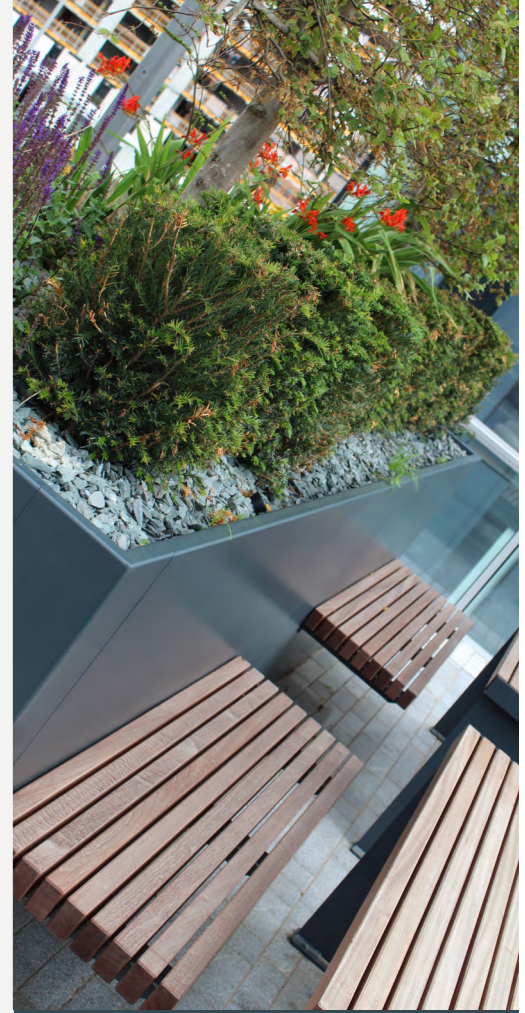
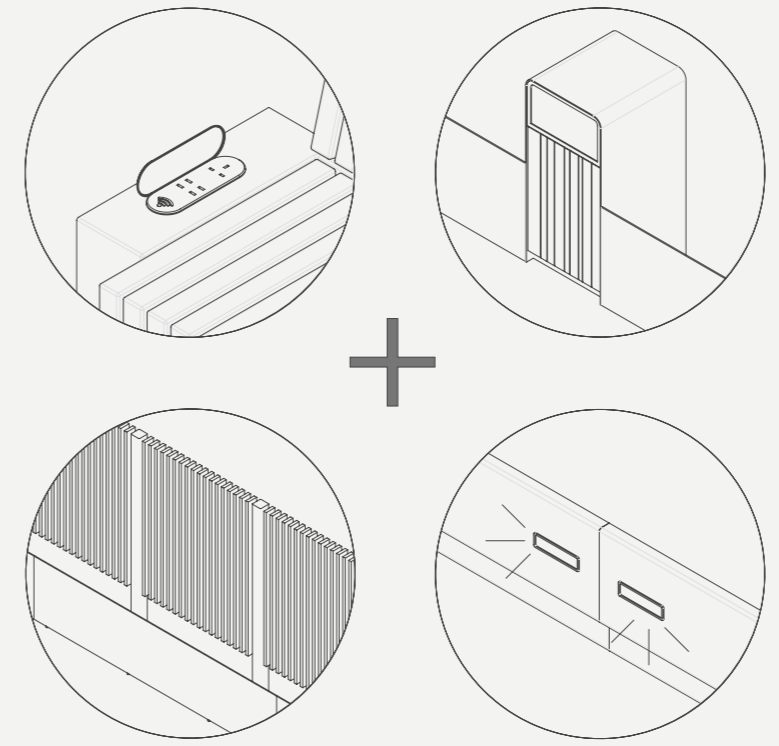

[Click here to view product page](#)

# INSPIRA projects

**Inspira** is a canvas on which to bring natural bursts of colour, public protection and a range of other environmental and social benefits to the built environment.

Whether on a roof terrace, an inner-city public space, a retail park or educational facility, the flexible nature of **Inspira** can contribute to a development's sustainability assessment, without compromising design intent.



**Biodiversity** - Increases the density of pollinator-friendly areas in the urban landscape.



**Pollution** - Uses planting to filter harmful airborne pollutants.



**Rainwater Management** - Absorbs rainwater, reducing runoff



**Climate Change** - Contributes to cooling of urban areas



**Acoustic Comfort** - Reduces reflection of soundwaves in cities.



**Mental Health** - Improves stress, respiratory & cardiovascular conditions and increases concentration

## Urban Safety



**Pedestrian protection** - The robust design of **Inspira** acts a protective barrier for pedestrians in built-up areas

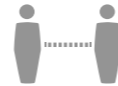

**Social distancing** - **Inspira's** Integrated seating can be dispersed to aid in meeting social distancing measures.

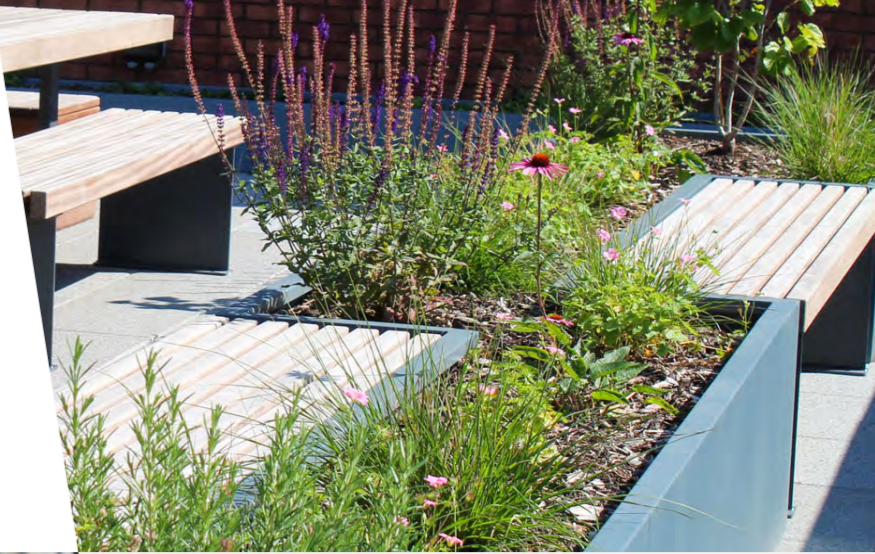

## The Value of Sustainability

By specifying **Inspira** during the design and planning phase, your development project will enjoy benefits including increased market value, higher rate of retention of residential and commercial tenants, and increased footfall in key commercial areas.



# INSPIRA seating

Add function to **Inspira** installations with a variety of seating options.

Seating provides social space and increases the accessibility of any public area. By interspersing seating modules throughout your **Inspira** installation, people have the opportunity to sit comfortably, enjoying a little bit of nature in the city.

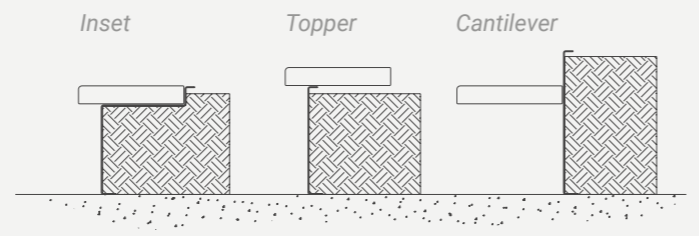

## Seating Options

### Front to Back

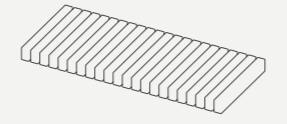

### Lengthways

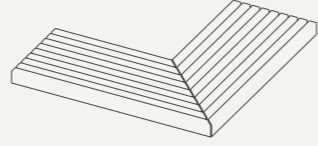
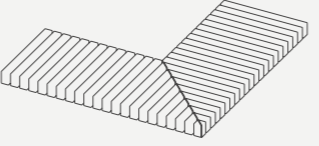
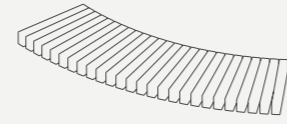
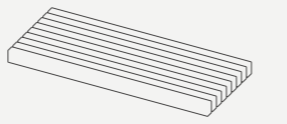

### Back & Arm Supports



## INSPIRA COMPONENTS Seating

		Lengths (mm)	Radius (mm)	Angles (°)
Linear	Inset	1000, 1200, 2000		
Linear	Cantilever	1000, 1200, 2000		
Linear	Topper	1000, 1200, 2000		
Form	Inset		800, 1200, 1400, 1600, 1800	45, 60, 90
Form	Cantilever		800, 1200, 1400, 1600, 1800	45, 60, 90
Form	Topper		800, 1200, 1400, 1600, 1800	45, 60, 90

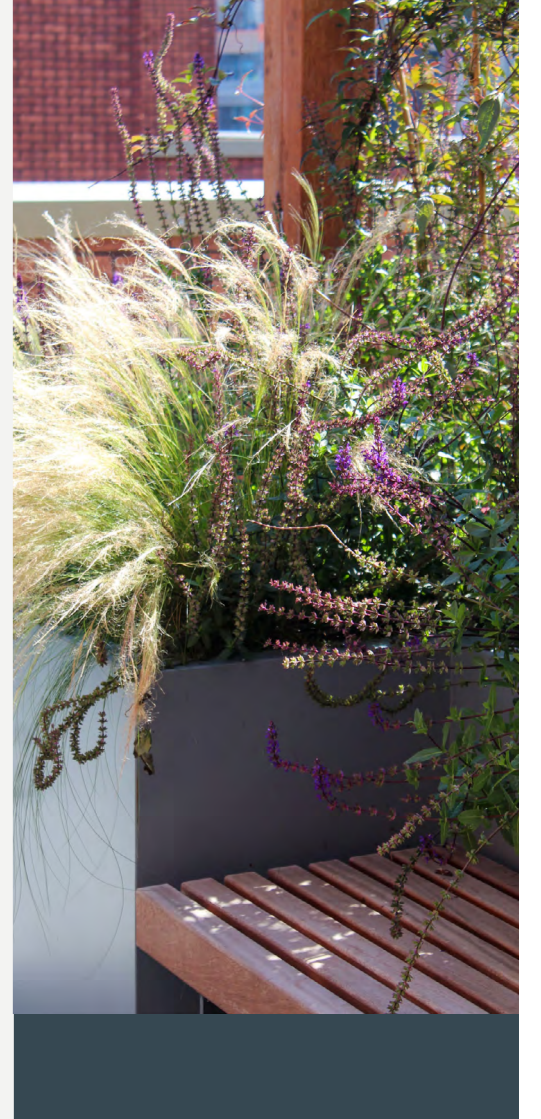

## MATERIALS

### ***Metal***

Metals are the obvious choice for constructing retaining walls. They withstand the forces of tons of stone and soil, but can also offer an elegance in the way they are formed and can provide myriad finishes and textures, blending seamlessly within the wider landscape.

We have chosen our base materials and finishes carefully to offer a robust and appealing product.



## MATERIALS

### ***Timber***

No material offers the natural warmth and unique tactility of timber.

It is the popular choice for seating and cladding to contrast and beautify the more industrial aesthetic of the supporting frame.

Our seating and accessories can be offered in a range of hardwoods for longevity and beauty, and softwoods for cost-effective and low-traffic installations.



**Corten Weathering Steel**



**Powder Coated Steel**



**Stainless Steel**

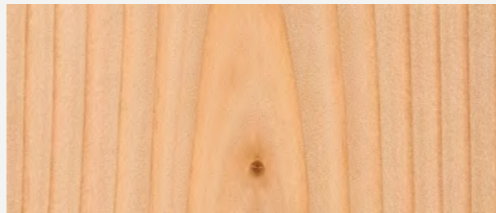

**Siberian Larch (Softwood)**

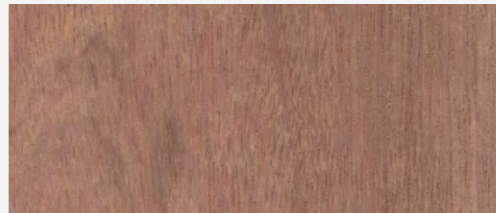

**Sapele (Hardwood)**



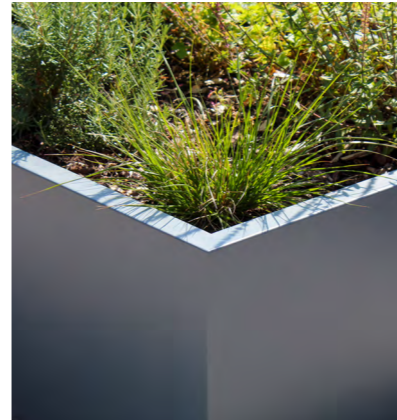
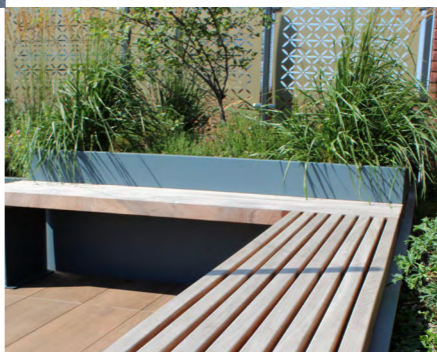

*Deansgate Square, Owens Street, Manchester*

*Inspira Planters featuring cantilever seating plus a coordinated street furniture package*

*Excelsior Works, Manchester*

*Inspira Planters featuring inset seating*

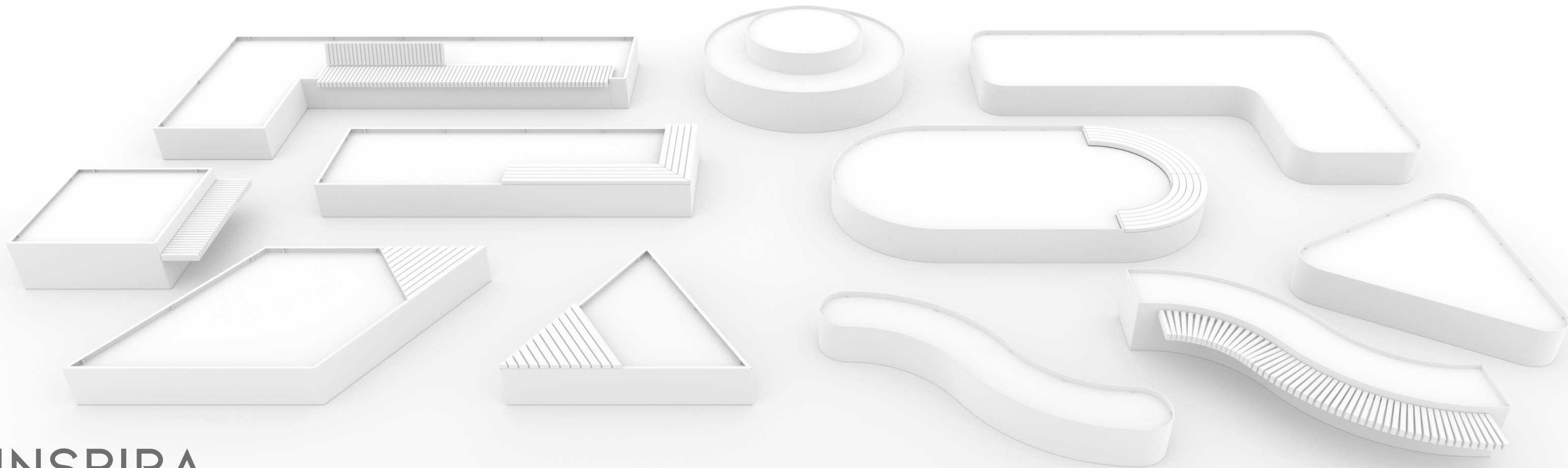

**INSPIRA**  
modular planting system



---

Bailey Street Furniture Group | Adlington Business Park | London Road | Adlington | Cheshire | SK10 4NL

t: 01625 855 900

e:enquiries@bsfg.co.uk