



CUPACLAD
by CUPA GROUP

NATURAL SLATE RAINSCREEN
CLADDING SYSTEMS



CONTENTS

CUPACLAD®, NATURAL SLATE RAINSCREEN CLADDING SYSTEMS.	03
NATURAL SLATE, A UNIQUE MATERIAL.	04
CUPACLAD®, THE SUSTAINABLE CLADDING.	05
THE EFFICIENCY OF A VENTILATED CLADDING.	06
CUPACLAD® SYSTEMS.	07
CUPACLAD® 101 Series. Invisible fixing.	08
<div style="display: flex; justify-content: space-around; margin-bottom: 10px;"> <div style="border: 1px solid white; padding: 5px; text-align: center;">101 <i>Logic</i></div> <div style="border: 1px solid white; padding: 5px; text-align: center;">101 <i>Random</i></div> <div style="border: 1px solid white; padding: 5px; text-align: center;">101 <i>Parallel</i></div> </div>	
CUPACLAD® 201 Series. Visible fixing.	18
<div style="border: 1px solid white; padding: 5px; text-align: center; margin-bottom: 10px;">201 <i>Vanguard</i></div>	
TECHNICAL GLOSSARY.	26
CUPACLAD® TECHNICAL ADVICE.	29
CUPACLAD® QUALITY.	30
CUPA PIZARRAS, THE WORLD LEADER IN NATURAL SLATE.	31

“Developed alongside Danish architects and contractors CUPACLAD® systems offer a revolution in cladding applications for natural slate. The systems offer a new durable, sustainable and easy to fix alternative with a unique character.”

★ Modern, contemporary design.

🍃 Lightweight and versatile.

The CUPACLAD® rainscreen cladding systems have been developed from the necessity of adapting natural slate to new architectural trends and styles that demand a more sustainable approach. The slate used in our systems is a natural product carefully selected for its durability and characteristics from our 16 quarries. The CUPACLAD® systems combine the efficiency of ventilated cladding and the properties of natural slate offering a competitive and sustainable alternative for all cladding requirements.

The CUPACLAD® range offers a number of alternatives guaranteeing a perfect adaptation for a variety of projects.

The fixings used for the CUPACLAD® systems have been developed following an in-depth design process to ensure a quick and easy installation.

CUPACLAD® offers a new world of design possibilities using natural slate.

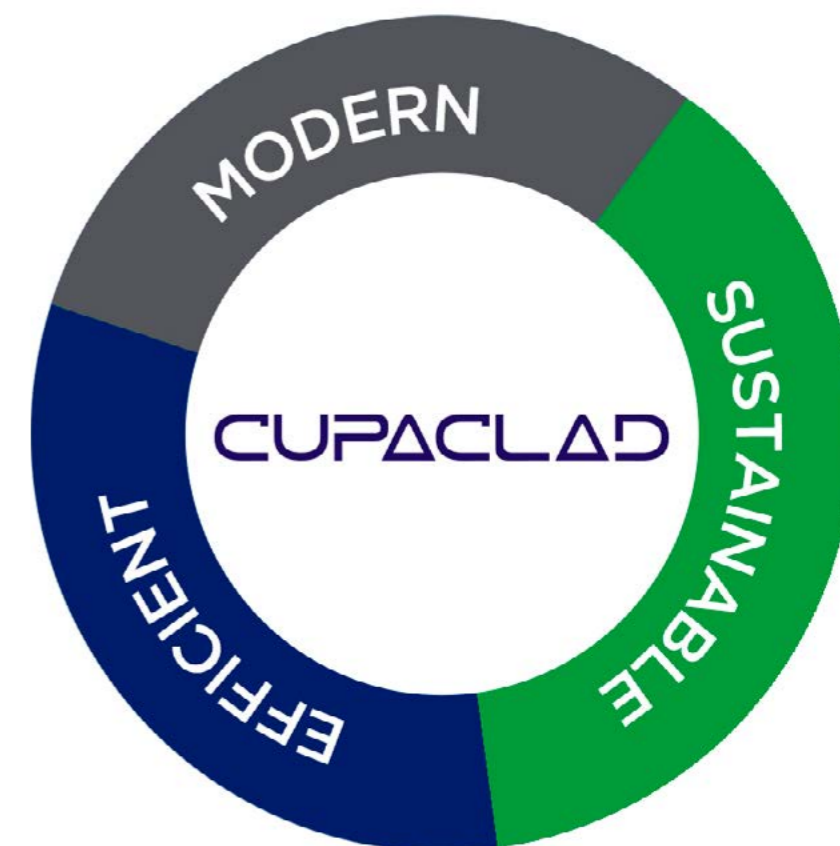

🕒 Highly durable.

🔧 Maintenance free.

🔩 Quick and easy to install.

🌿 Environmentally friendly and sustainable.

✅ Efficient as a rainscreen cladding.

⊕ Complementary to external insulation systems.

NATURAL SLATE, A UNIQUE MATERIAL

Slate is a natural product of unparalleled technical properties that adds value to any project.



Durability



Environmentally friendly



Character

Used since roman times, natural slate is long-lived, remarkably durable, fire resistant and naturally waterproof. Its aesthetic and technical properties remain unaltered, keeping the elegance and character for much longer than any man made alternatives.

Each slate is handcrafted by our skilled "splitters", with no additional treatment required. Natural slate is only subject to extraction and mechanical transformation; there are no chemical or heating processes involved as with alternative materials. This and its unparalleled durability result in natural slate being a material with an extremely low carbon footprint.

Characterised by its natural colour and individual texture, natural slate is a material that can enhance the value and beauty of any property. Every slate is unique giving an unparalleled character to any project remaining unaltered for many years.

CUPACLAD® SLATE CLADDING

CUPACLAD® natural slate is specially selected from among our 16 quarries for its technical properties and is subjected to specific quality controls to guarantee exceptional performance in any facade. CUPACLAD® ensures quick and easy installation thanks to the greater regu-

larity and flatness of the slates, which are delivered with the holes made to match the selected CUPACLAD® system. Even its packaging, which is smaller and lighter, has been designed to facilitate and shorten installation times. CUPA PIZARRAS have been quarrying natural slate for more than 120 years. Our quality control experts choose the perfect slate for each system based on wind load and impact criteria to guarantee its performance as a cladding

material. Our CUPACLAD® slate cladding meets and exceeds the highest European quality standards.



CUPACLAD®, THE SUSTAINABLE CLADDING

CUPACLAD® natural slate systems are the perfect alternative for an efficient and sustainable cladding.

Due to the nature of the slate production process, our CUPACLAD cladding has a lower environmental impact than other man made alternatives. 5 times less CO2 emissions than fibre cement, 324 times less water consumption than zinc cladding and 10 times less energy consumption than clay.



AIR POLLUTION



WATER CONSUMPTION

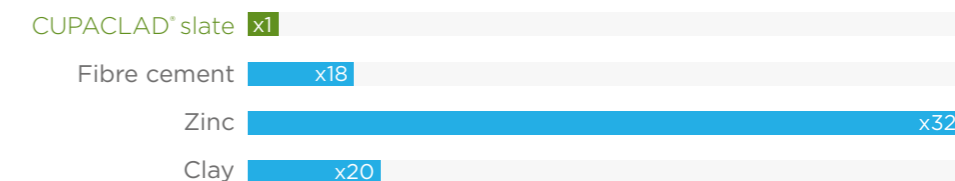

ENERGY CONSUMPTION



*Life-cycle assessment, studies all the stages of a product's life from production to recycling. Data calculated for 1 square meter in a year. Sources: CUPACLAD® slate (<http://goo.gl/K5Lx8>); Fibre cement (<http://goo.gl/OSjeV5>); Zinc (<http://goo.gl/EgWh6g>); Terracotta (<http://goo.gl/Y03c9U>).

LIFE-CYCLE ASSESSMENT

Life-cycle assessments allow measurement of the environmental footprint from a cradle to grave perspective. They confirm CUPACLAD® as a sustainable option for cladding due to the use of natural slate versus man-made products.

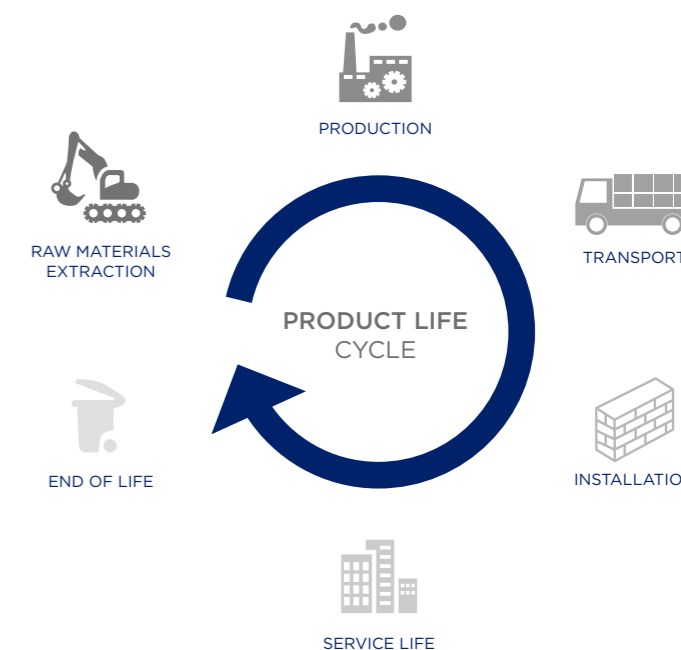

THE EFFICIENCY OF A RAINSCREEN CLADDING

“Rainscreen cladding is a construction solution widely used and popular amongst Architects and developers worldwide.”

Now considered the most efficient system for construction envelope purposes. The combination of a ventilated system together with an insulation system gives numerous advantages in terms of thermal and acoustic properties. It avoids thermal bridges and condensation issues.

The rainscreen cladding system consists of a load bearing wall, a layer of insulation and a covering material fixed to the building with the help of a supporting structure. This system

creates a gap between the insulation and covering material called an air cavity.

For optimum performance the system must allow constant air circulation through the cavity creating a natural convection process. Warm air inside the cavity is lifted and released to the exterior resulting in a continuous ventilation cycle. This so called “chimney effect” is one of the advantageous characteristics of a rainscreen cladding.

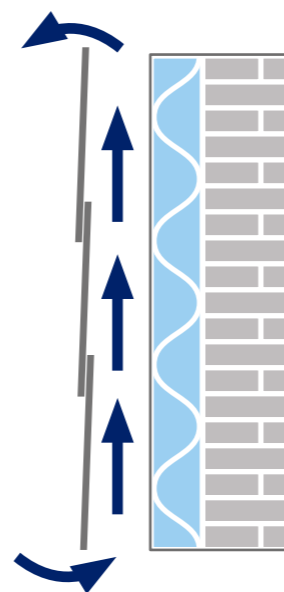

MAIN ADVANTAGES:



Elimination of Humidity

Rainwater penetration is greatly reduced and any moisture is removed through the constant ventilation, reducing the risk of any condensation.



Structural movement reduction

The air cavity avoids temperature variations resulting in less pronounced structural movements. This reduces the risk of cracks and other structural issues.



Energy savings

Thermal efficiency is increased due to the cooling effect in summer and greater heat retention in winter.



Durability

The cladding material is kept dry due to continuous ventilation. Many issues related to humidity (efflorescence etc...) are reduced resulting in a longer life span of the installation.

CUPACLAD® SYSTEMS

“CUPACLAD® systems have been developed to be able to adapt to any kind of project combining alternative fixing methods and slate formats.”

101 SERIES

Invisible fixing

101
Logic



Simple and balanced

101
Random



Dynamic and creative

101
Parallel



Uniform and regular

201 SERIES

Visible fixing

201
Vanguard



Modern and efficient



P.09



P.10



P.11



P.19



ACCURACY AND RELIABILITY OF INSTALLATION



MAXIMUM FIRE RESISTANCE



COMFORMITY WITH REQUIRED TECHNICAL STANDARDS

101 SERIES
FIXING
METHOD



Slates are fixed using our specially designed screws self-drilling to ensure optimal installation while remaining completely invisible to minimize design impact.

Screws are made of stainless steel with a large flat head that enables an easier and more secure fixing.

CUPACLAD® 101 *Logic*

SIMPLE AND BALANCED

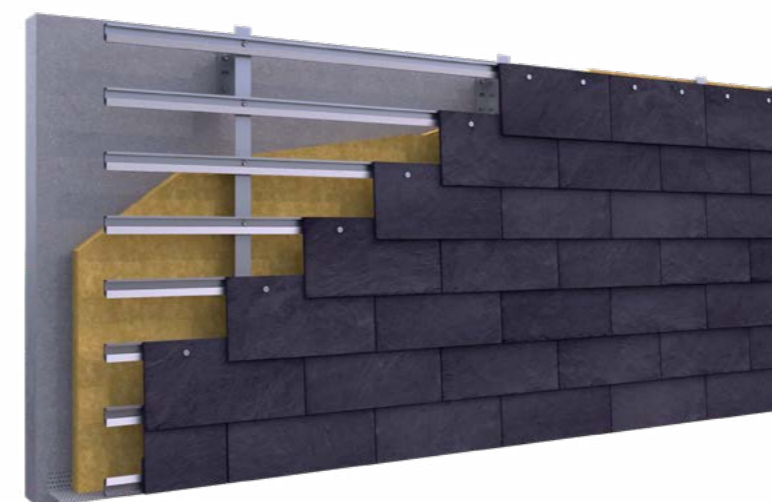

CUPACLAD® 101 *Logic* features a balanced design that highlights the unique texture and looks of the natural slate.

CUPACLAD® 101 *Logic* system utilizes 40x20cm slates fitted horizontally with invisible fixings.

Slate size	40x20 cm
Nominal thickness	7.65 mm
Slates per m ²	16.7
Weight per m ² (slate)	≤30 kg/m ²



INVISIBLE FIXING SYSTEMS

101
SERIES

CUPACLAD® serie 101 features invisible fixings, making the slate the main feature of the cladding.

CUPACLAD® 101 *Random*

DYNAMIC AND CREATIVE

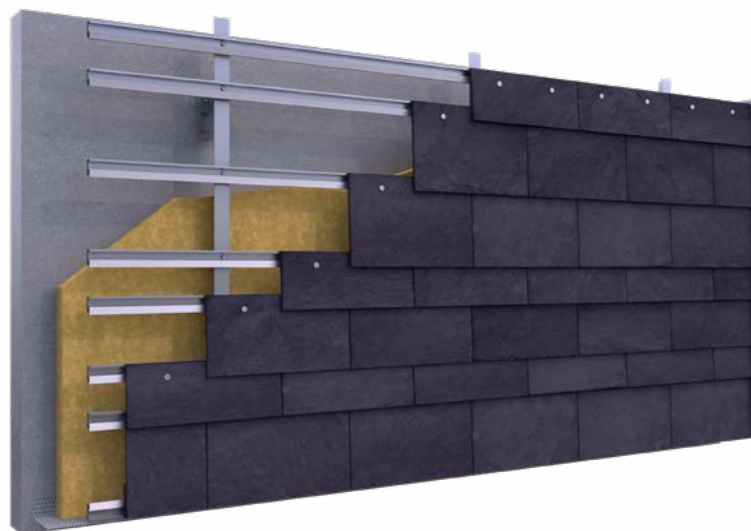

CUPACLAD® 101 *Random* combines different slate sizes, creating a dynamic and unique design.

CUPACLAD® 101 *Random* features 50x25, 50x20 and 50x15 slates fitted horizontally with invisible fixings.

Slate size	50x25 cm 50x20 cm 50x15 cm
Nominal thickness	7.65 mm
Slates per m ²	± 15
Weight per m ² (slate)	≤30 kg/m ²



CUPACLAD® 101 *Parallel*

UNIFORM AND REGULAR

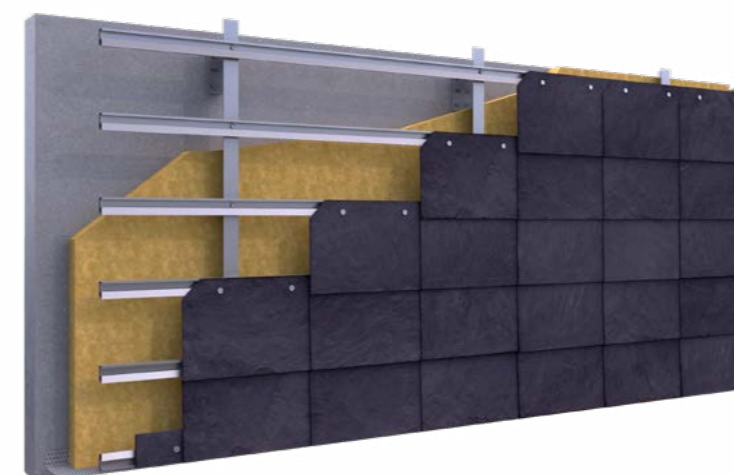

CUPACLAD® 101 *Parallel* features a regular design with even joints. This results in a uniform and consistent layout that highlights the character of natural slate.

CUPACLAD® 101 *Parallel* features 40x25 horizontally aligned slates fitted with invisible screws.

Slate size	40x25 cm
Nominal thickness	7.5 mm
Slates per m ²	14.3
Weight per m ² (slate)	≤30 kg/m ²



CUPACLAD® SERIES 101

FIXING METHOD

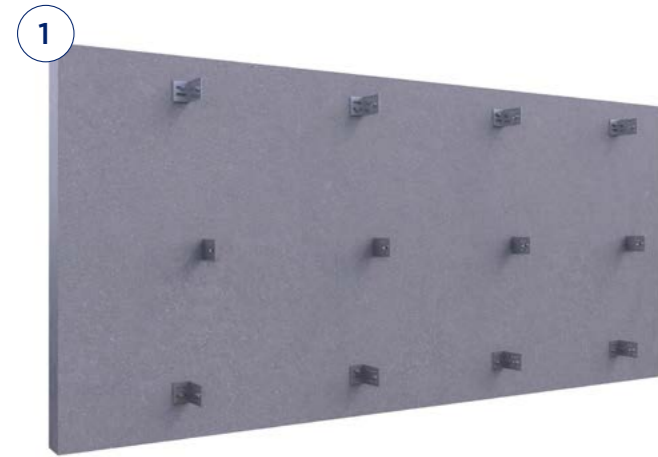

Fixing the metal brackets

The metal brackets are installed in alternate courses on each side of the vertical profile. It is required to use both fixed point metal brackets (on the upper end of each profile) and brackets with a sliding point to allow for expansion of the profile.

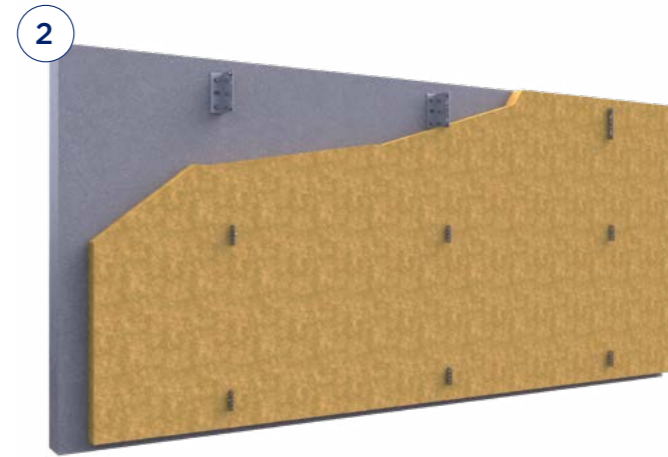

Fixing of insulation

Choose the most suitable insulation material based on the project requirements. Fixing in accordance with the manufacturers recommendations.

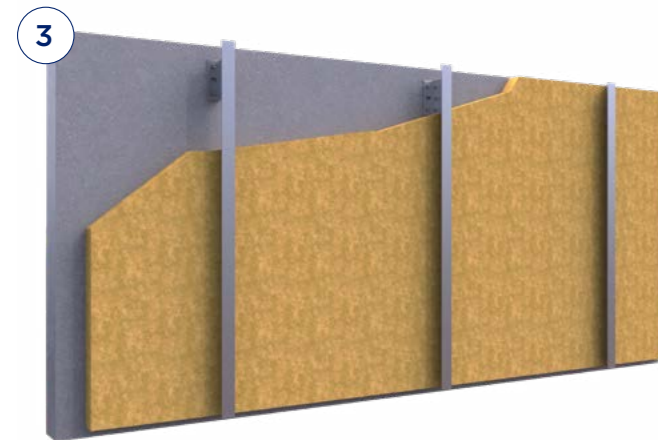

Fixing the "L" shaped profiles

Fix the vertical profiles to the metal brackets allowing at least 2 cm for an air cavity. The vertical profiles must be perfectly level before fitting the remainder of the system components.

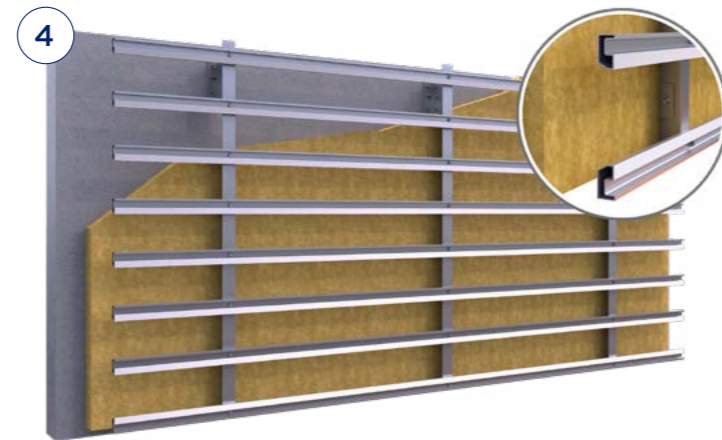

Fixing the CUPACLAD® 101 horizontal profiles

Fix the horizontal profiles with the vertical ones at each intersection. The horizontal profiles must be perfectly level as their position will dictate the final position of the slates. Fit also an inverted 101 horizontal profil at the first course of the cladding to allow fixing of the first course slate.

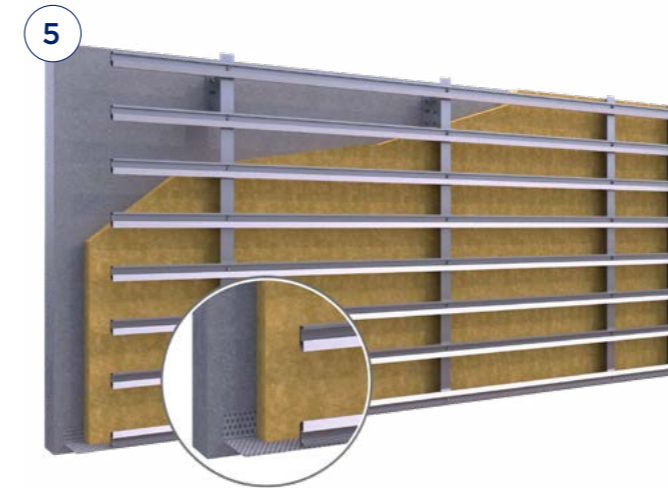

Fixing the flashings

Fix a ventilation flashing at the first course of the cladding and the metal flashings at single points (edges, window frames, etc...).

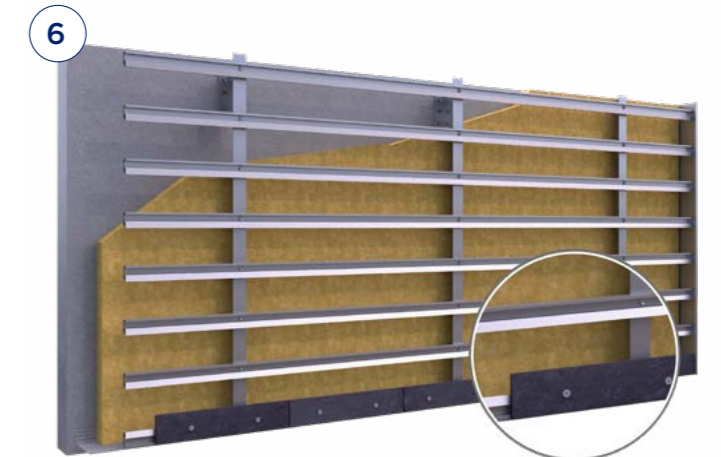

Fixing the first course slate

Cut a slate to a height of 80 mm approx. Fix it inverted matching the bottom edge of the slate with the first 101 horizontal profile.



Fixing the slates with the self-drilling CUPACLAD® 101 screw

Each slate must be aligned with the upper edge of the profile and fitted with two stainless steel. CUPACLAD® 101 self-drilling screws.

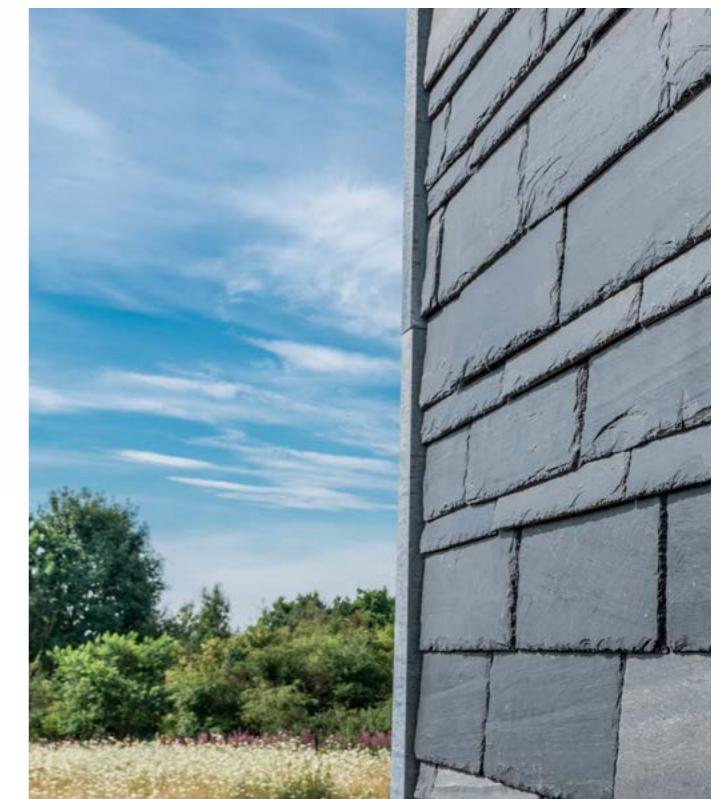

TECHNICAL DETAIL CUPACLAD® 101 *Logic*

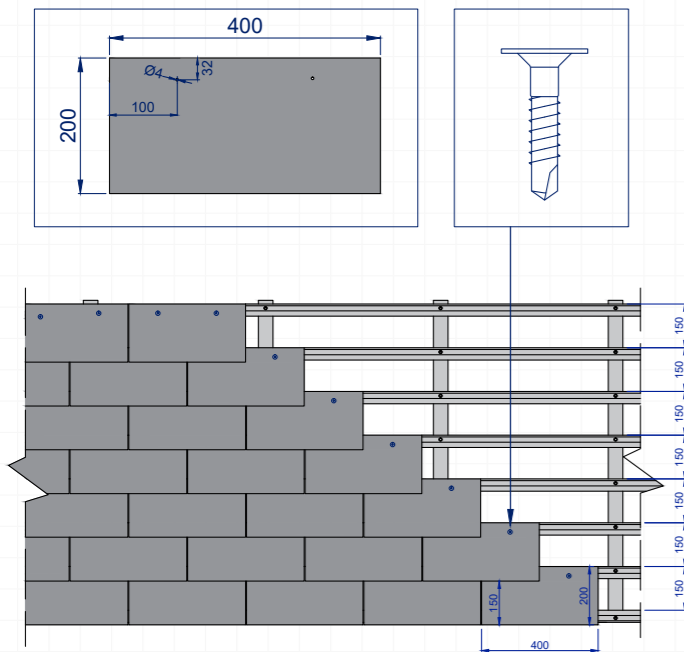

TECHNICAL DETAIL CUPACLAD® 101 *Random*

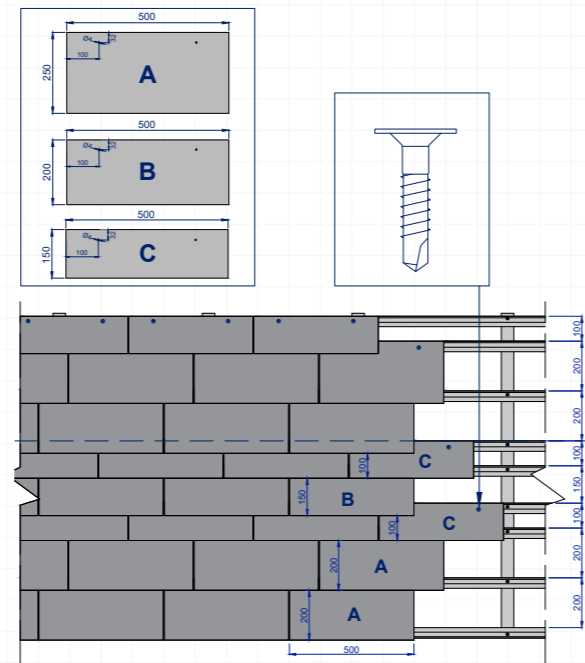

TECHNICAL DETAIL CUPACLAD® 101 *Parallel*

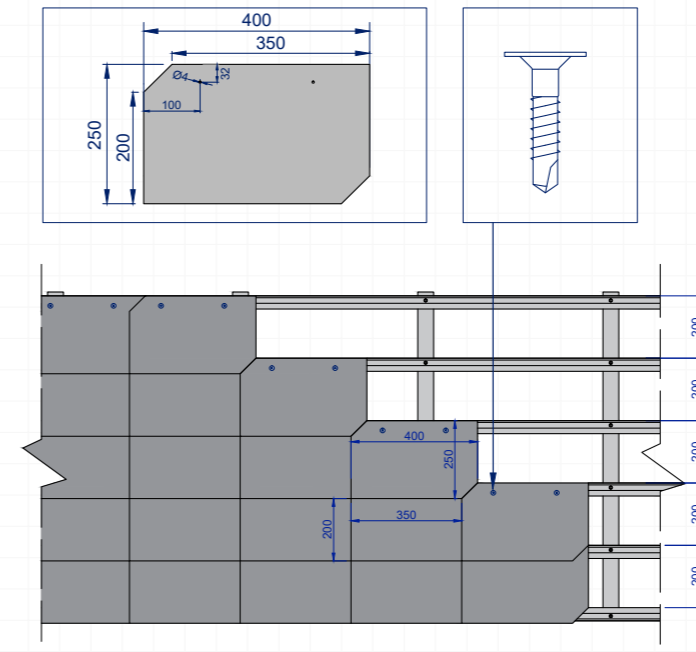

CONSTRUCTION DETAILS
CUPACLAD® 101 (*Logic, Random y Parallel*)

VENTILATED PROFILE AND TOP FLASHING

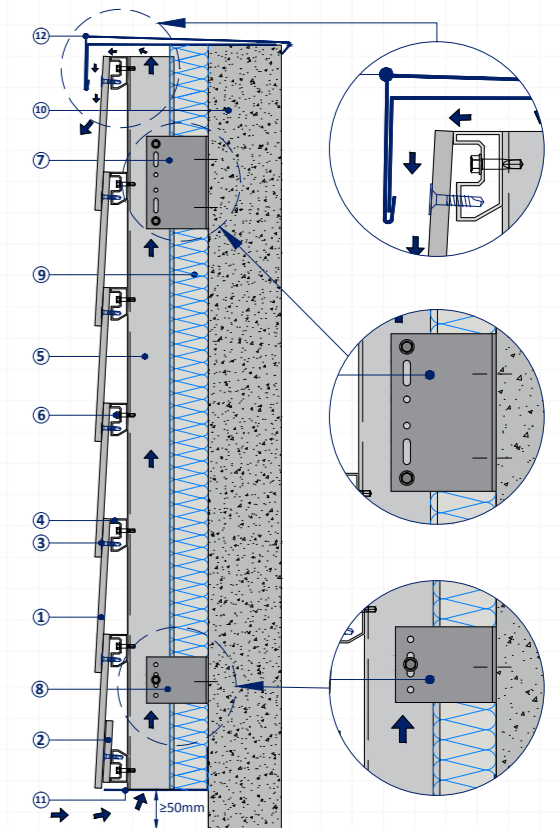

EXTERNAL WINDOW REVEAL

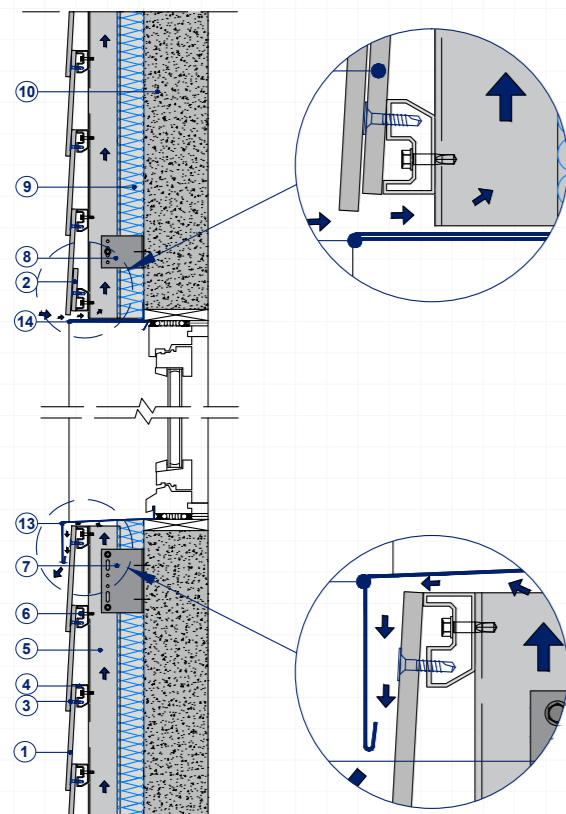

TOP FLASHING FOR PITCHED ROOF

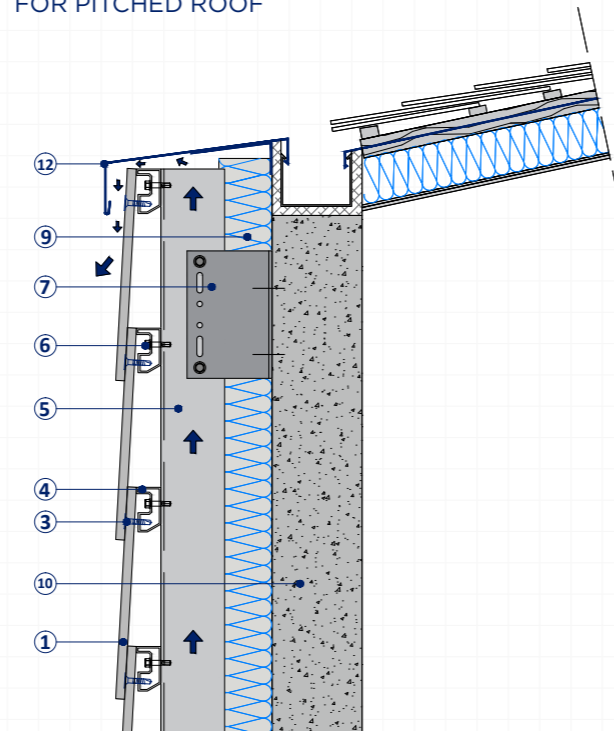

- | | |
|--|---------------------------|
| 1. CUPA PIZARRAS natural slate | 9. Insulation |
| 2. First course slate | 10. Load bearing wall |
| 3. Self-drilling CUPACLAD® 101 screw | 11. Ventilated flashing |
| 4. Horizontal CUPACLAD® 101 profile | 12. Top metal flashing |
| 5. "L" shaped vertical profile 50x60 | 13. Sill metal flashing |
| 6. Self-drilling stainless steel screw | 14. Metal lintel flashing |
| 7. "Fixed point" metal bracket | 15. Metal jambs flashing |
| 8. "Sliding point" metal bracket | 16. Metal flashing |

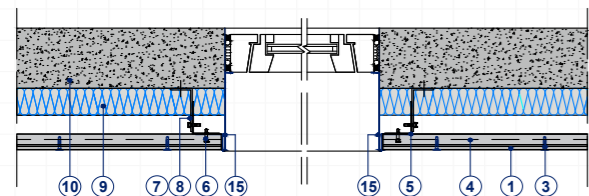

AIR CAVITY

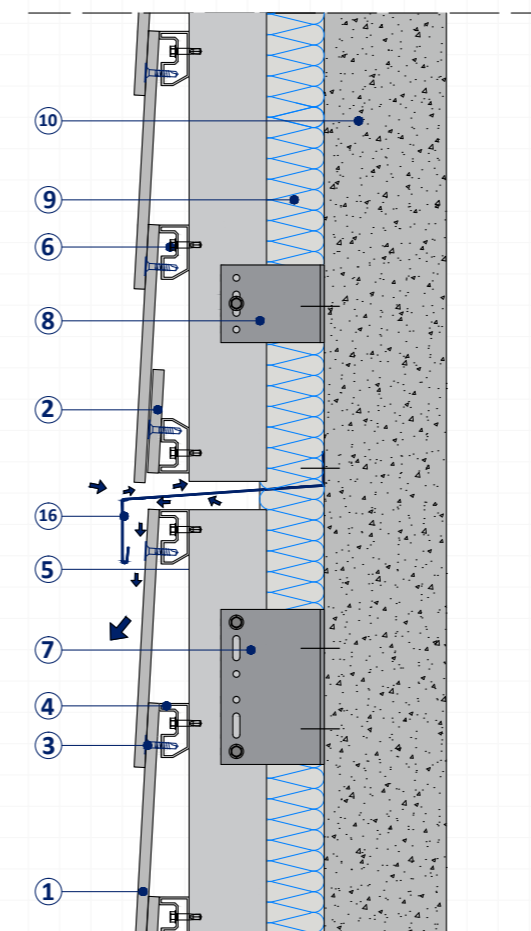

CORNER FLASHINGS

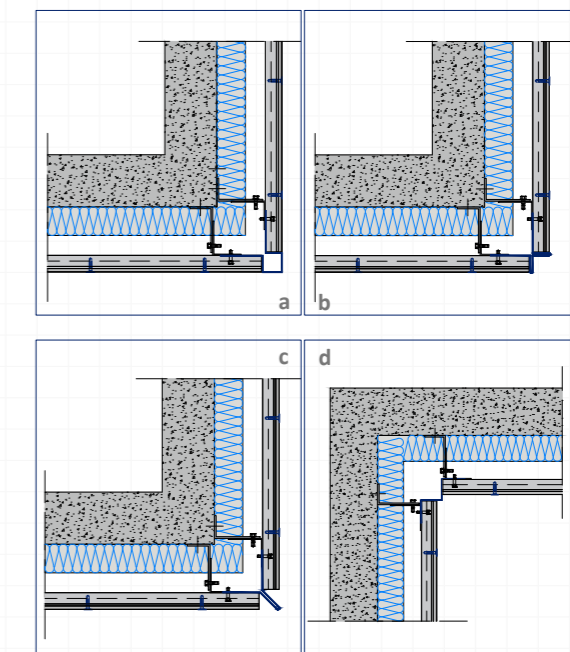

1. CUPA PIZARRAS natural slate
2. First course slate
3. Self-drilling CUPACLAD® 101 screw
4. Horizontal CUPACLAD® 101 profile
5. "L" shaped vertical profile 50x60
6. Self-drilling stainless steel screw
7. "Fixed point" metal bracket
8. "Sliding point" metal bracket
9. Insulation
10. Load bearing wall
11. Ventilated flashing
12. Top metal flashing
13. Sill metal flashing
14. Metal lintel flashing
15. Metal jambs flashing
16. Metal flashing

CUPACLAD[®]

SERIE 101

Logic, Random y Parallel

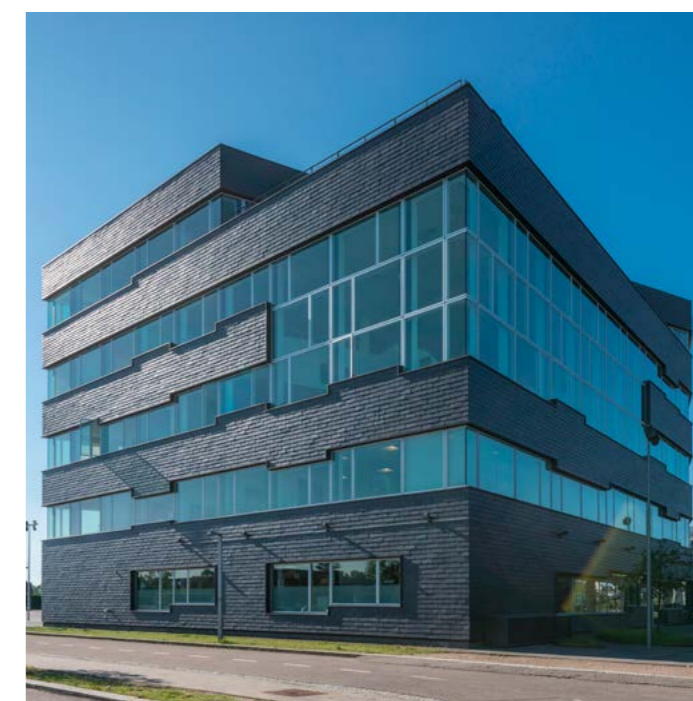
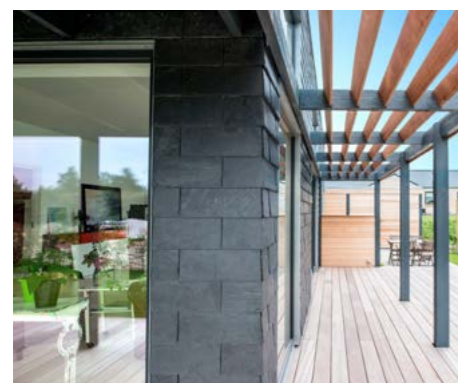
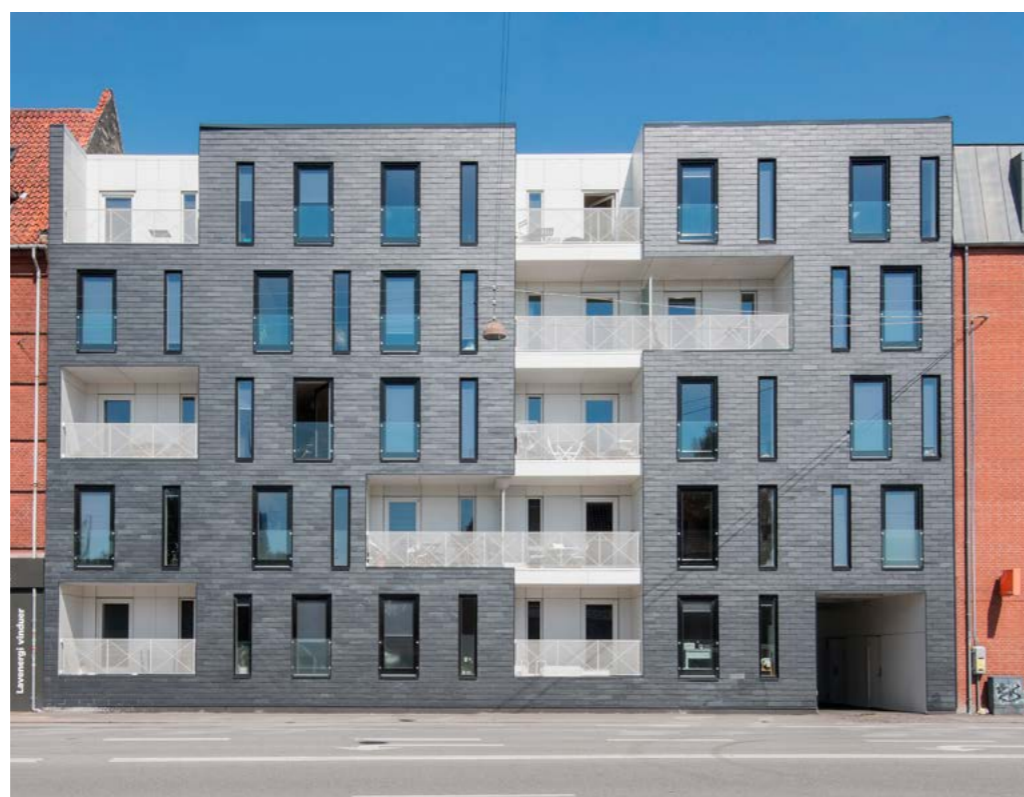
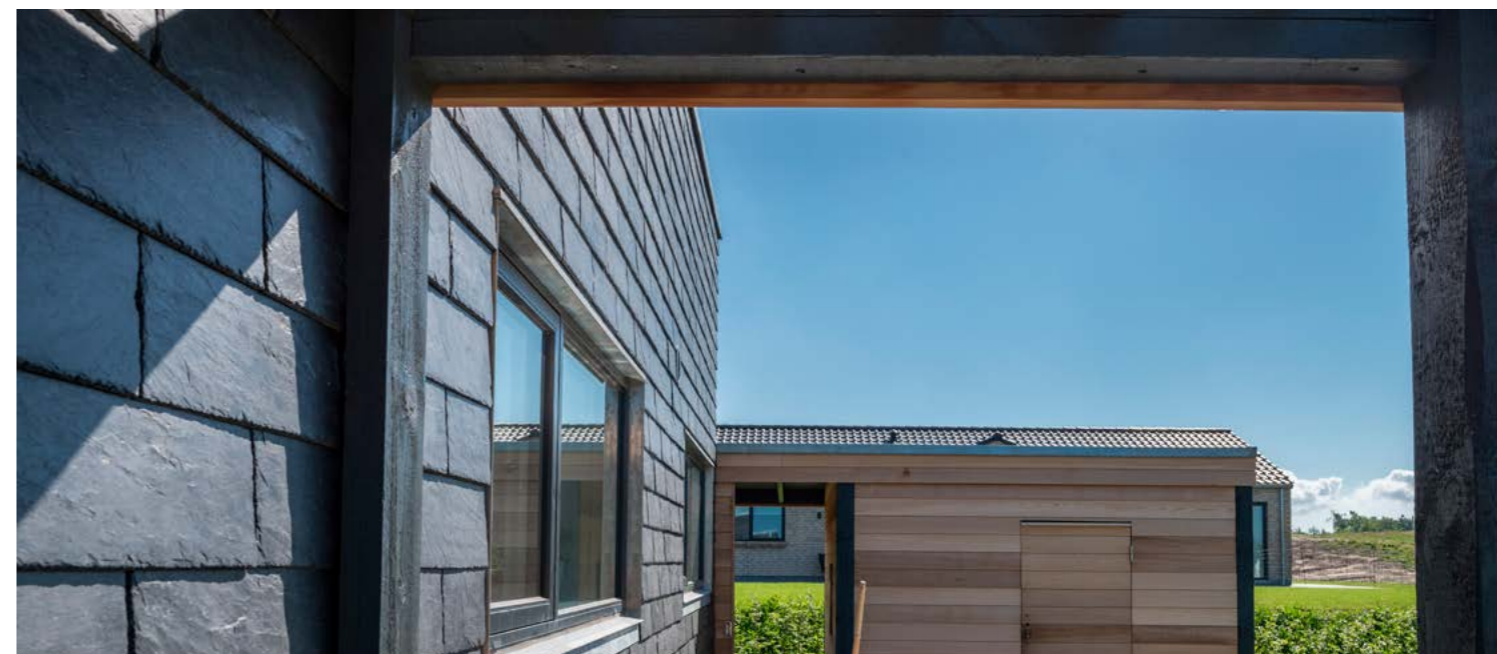

FIXING SYSTEM
201 Vanguard



CUPACLAD® 201 Vanguard stainless steel clips have been designed by our R&D department.

Every slate is fixed to the horizontal profile using two clips that remain partially visible once the system is installed.

CUPACLAD® 201 Vanguard

MODERN AND EFFICIENT

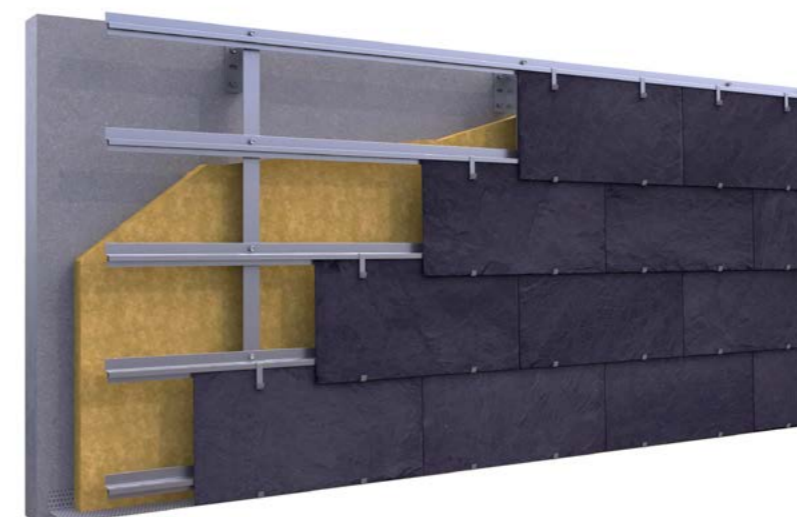

CUPACLAD® 201 Vanguard main feature is the combination of big slates and stainless steel brackets giving as a result a clean combination of contemporary appeal.

CUPACLAD® 201 Vanguard features 60x30 cm slates fitted horizontally with visible fixings.

Slate size	60x30 cm
Nominal thickness	7.5 mm
Slates per m ²	6.4
Weight per m ² (slate)	≤25 kg/m ²

VISIBLE FIXING SYSTEM

201 SERIES

CUPACLAD® 201 series is identified by the use of stainless steel visible fixings. **The contrast between natural slate and steel gives this cladding a unique modern appearance.**



PATENTED SYSTEM

CUPACLAD® 201 Vanguard is a patented system developed by our R&D department that is designed to meet the highest technical requirements of the construction industry.



EASE OF INSTALLATION

Our metal rails feature small holes in them to mark the exact position where the clips should be placed. This avoids the necessity of drawing vertical guidelines and individual fixings for the clips.



PERFECT RESULT

The stainless steel clips have flanges that work just like a spring absorbing differences in the thickness of the slates resulting in a perfect leveled cladding surface.

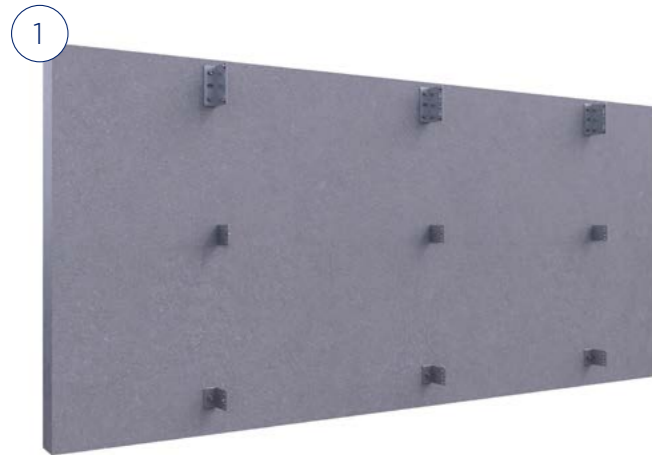

Fixing the metal brackets

The metal brackets are installed in alternate courses on each side of the vertical profile. It is required to use both fixed point metal brackets (on the upper end of each profile) and brackets with a sliding point to allow for the profile movement.

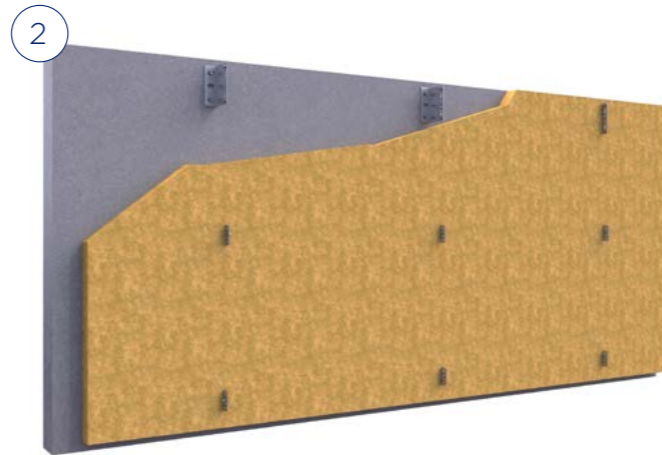

Fixing of insulation

Choose the most suitable insulation material based on the project requirements. Fixing in accordance with the manufacturers recommendations.

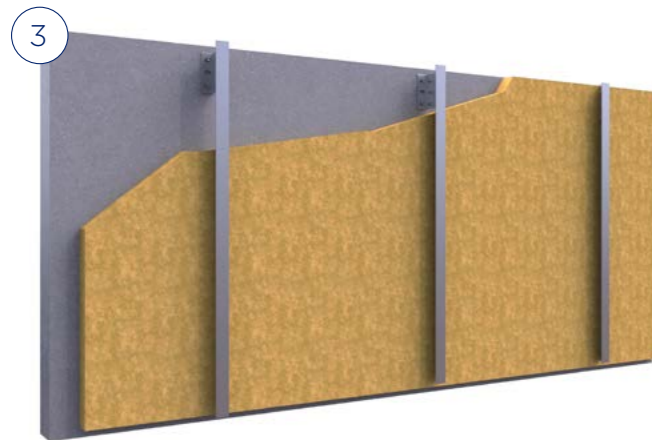

Fixing the "L" shaped vertical profiles

Fix the vertical profiles to the metal brackets allowing at least 2cm for an air cavity. The vertical profiles must be perfectly level before fitting the rest of the system components.

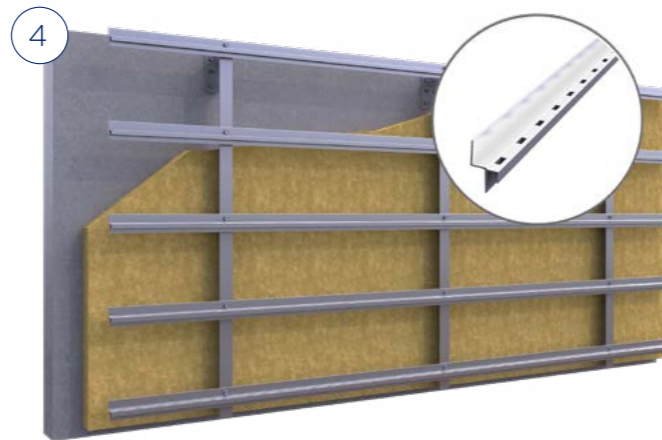

Fixing the CUPACLAD® 201 Vanguard horizontal profiles

Fix the horizontal profiles with the vertical ones at each intersection. The gap between horizontal profiles when fitting a 60x30 slate must be 260 mm. The horizontal profiles must be perfectly level as their position will dictate the final position of the slates.

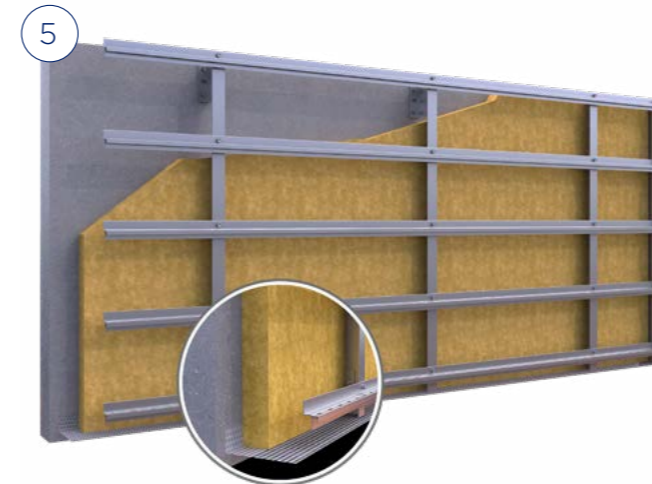

Fixing the flashings

Fix a ventilated flashing at the first course of the cladding and the metal flashings on "singular" points (edges, window frames, etc...).

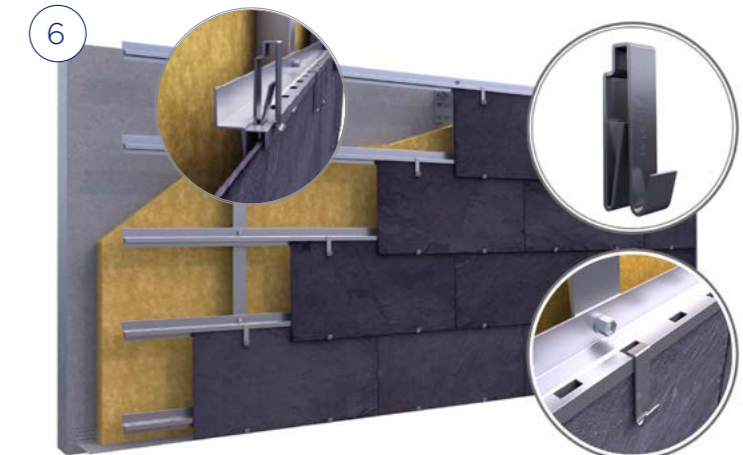

Fixing the slates with the special CUPACLAD® 201 Vanguard clips

The clips are fitted to the holes in the horizontal profiles. Each slate is supported by two clips on the lower edge while fitted with another two on the top.

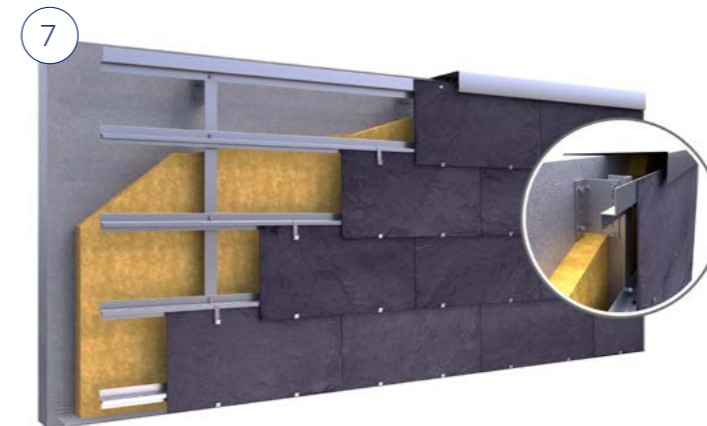

Fixing the slates to the top of the cladding

At the top of the cladding when joining the gutters or flashing it is necessary to use the 201-V top profile to which the slate must be fitted with two self-drilling screws or rivets.

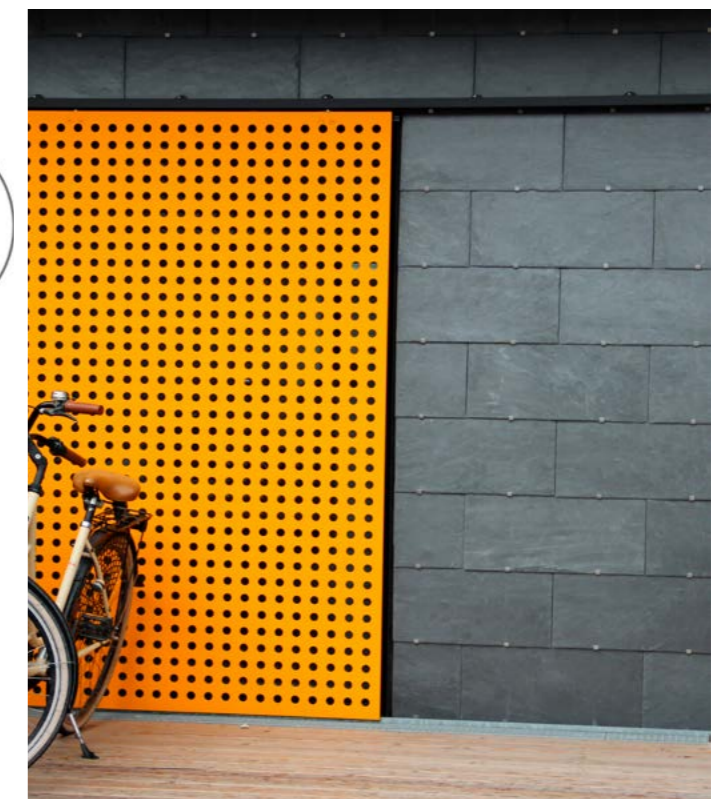

TECHNICAL DETAIL CUPACLAD® 201 Vanguard

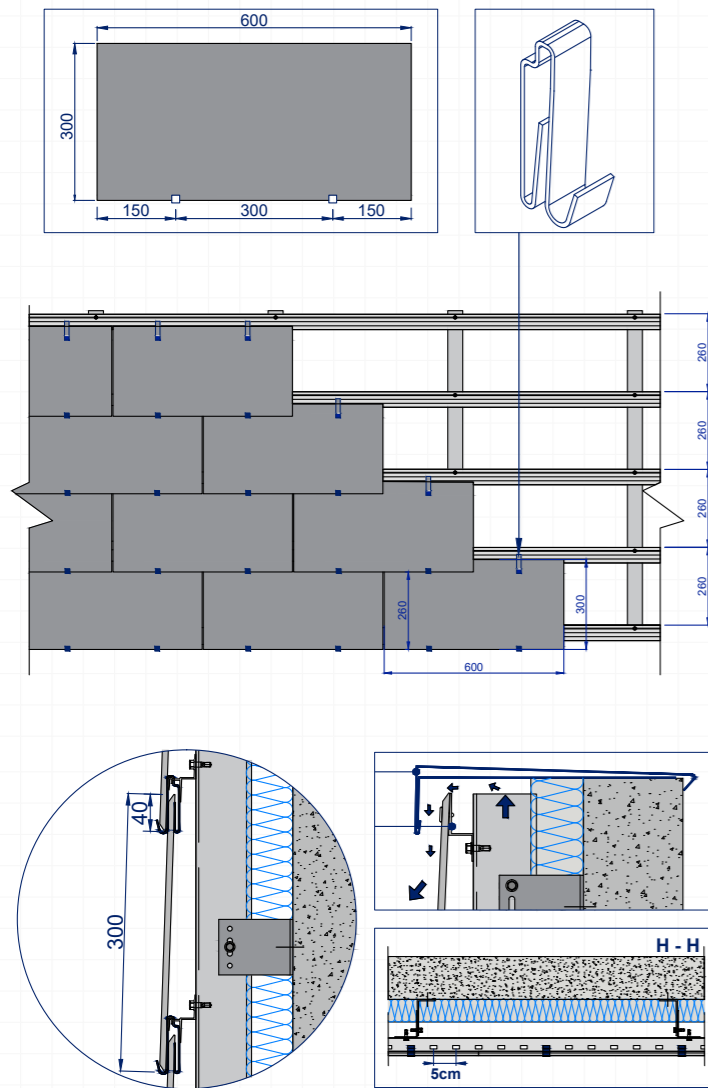

CONSTRUCTION DETAILS
CUPACLAD® 201 Vanguard

VENTILATED PROFILE AND TOP FLASHING

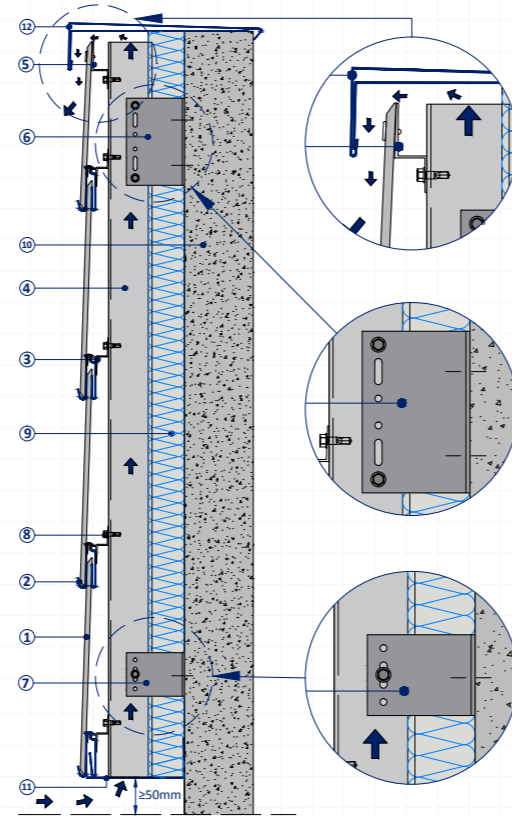

EXTERNAL WINDOW REVEAL

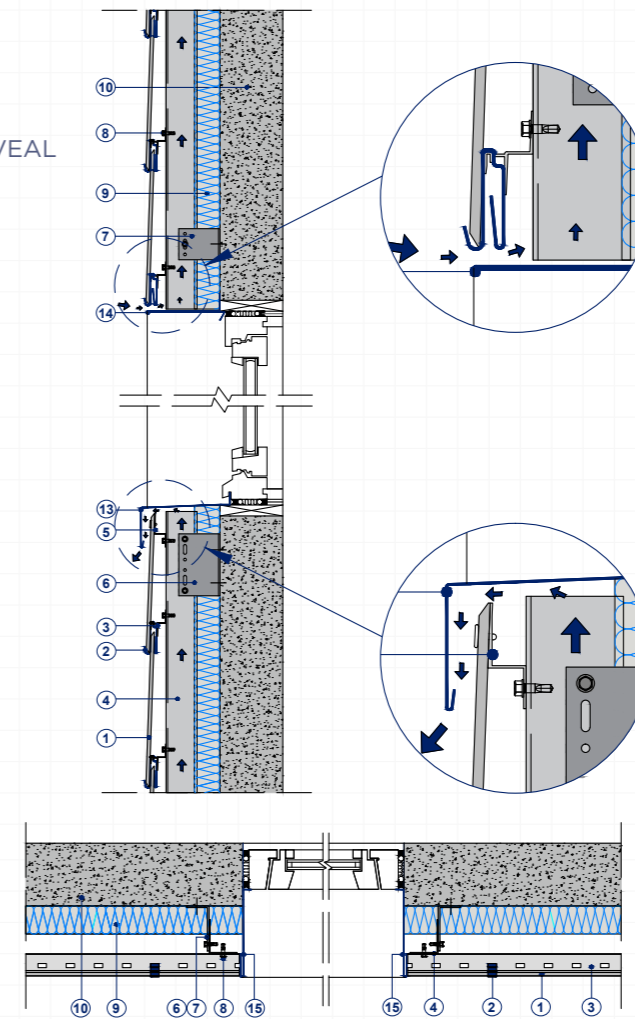

1. CUPA PIZARRAS natural slate
2. CUPACLAD® 201-V Clip
3. Horizontal CUPACLAD® 201-V profile
4. L shaped 50X60 vertical profile
5. CUPACLAD® 201-V top profile
6. Metal bracket, "fixed point"
7. Metal bracket "sliding point"
8. Self-drilling stainless steel screws
9. Insulation
10. Load bearing wall
11. Ventilated profile
12. Top metal flashing
13. Sill metal flashing
14. Metal lintel flashing
15. Metal jambs flashing
16. Metal flashing

AIR CAVITY

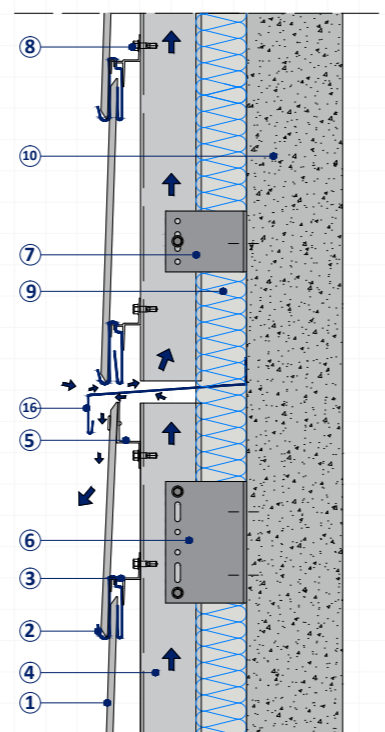

TOP FLASHING FOR PITCHED ROOF

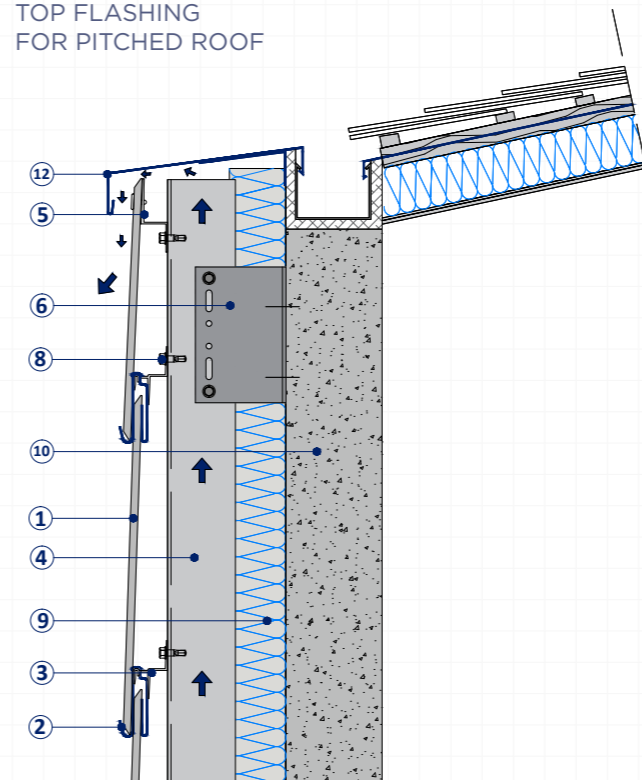

CORNER FLASHINGS

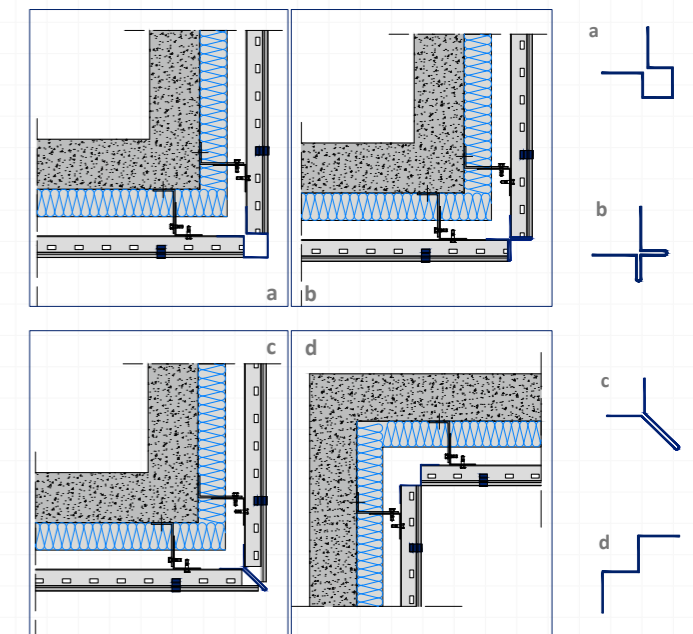

1. CUPA PIZARRAS natural slate
2. CUPACLAD® 201-V Clip
3. Horizontal CUPACLAD® 201-V profile
4. L shaped 50X60 vertical profile
5. CUPACLAD® 201-V top profile
6. Metal bracket, "fixed point"
7. Metal bracket "sliding point"
8. Self-drilling stainless steel screws
9. Insulation
10. Load bearing wall
11. Ventilated profile
12. Top metal flashing
13. Sill metal flashing
14. Metal lintel flashing
15. Metal jambs flashing
16. Metal flashing

CUPACLAD[®]

201 Vanguard

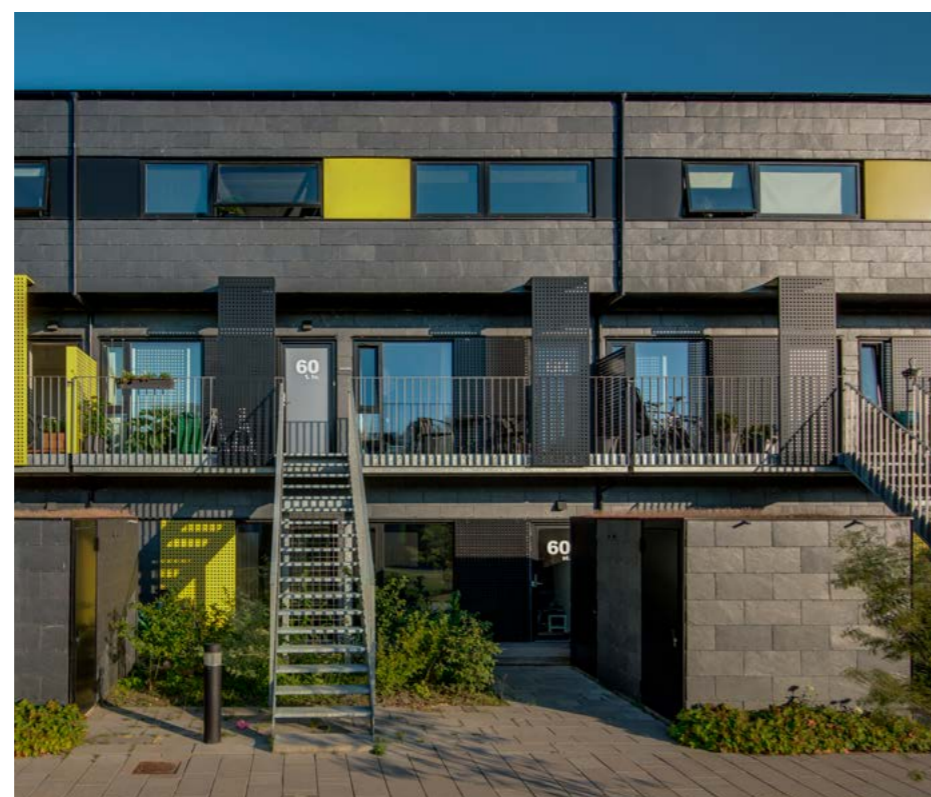
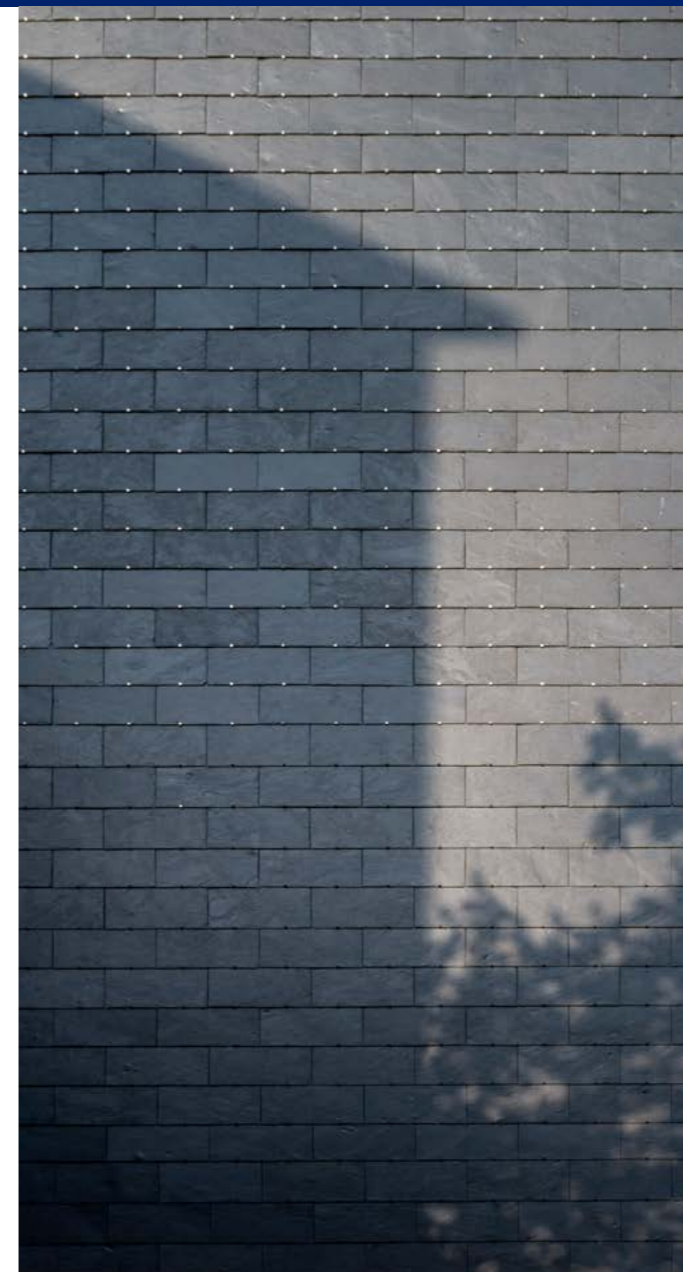

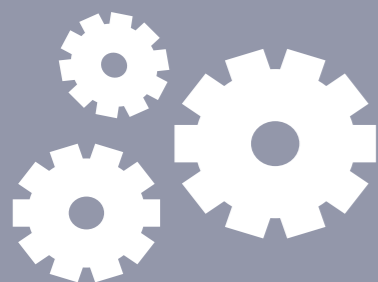

CUPACLAD® SYSTEMS COMPONENTS

a. Exclusive Cladding range, the slate for CUPACLAD® systems

b. Primary substructure

b.1. CUPACLAD® 101 systems
Logic, Random y Parallel

||| CUPACLAD® 101 screw

||| CUPACLAD® 101
horizontal profile

b.2. CUPACLAD® 201 system
Vanguard

||| 201 Vanguard special clip

||| 201 Vanguard horizontal
profile

||| 201 Vanguard flashings

c. Secondary substructure

||| Metal bracket

. Fixed point

. Sliding point

||| Vertical rail

d. Screws.

e. Air cavity.

f. Insulation material.

g. Waterproof membrane.

h. Flashings.

i. Load bearing wall.

a. Exclusive Cladding range, the slate for CUPACLAD® systems

The CUPA PIZARRAS slate used for the CUPACLAD® systems has a 7.5mm nominal thickness and a textured surface. It has been carefully selected for its technical properties to offer a flawless installation and performance.

The slate supplied for the invisible fixing systems is always pre-holed at the required position, making its installation quicker and problem free.

The amount of slate needed for a certain project must be always increased by 5% to allow for the waste generated by the finishing details on the cladding (corners, window sills...).

b. Primary substructure

b.1. CUPACLAD® 101 systems *Logic, Random and Parallel*

• CUPACLAD® 101 screw

CUPACLAD® 101 series screws self-drilling have been developed to ensure optimal installation to the metallic structure. Produced in AISI 316 (A4) stainless steel they feature a flat head that guarantees a flawless fixing.

• CUPACLAD® 101 horizontal profile

The CUPACLAD® 101 horizontal profile was designed by our R&D department to ease the installation of the slates with invisible fixings. It is made in 6060-T6 aluminium alloy.

The horizontal profiles must be perfectly level as their position defines the alignment of the slates. Taking the top edge of the profile as the reference.

The distance between profiles is defined for each system based on the slate size used (see page 14 and 15).

b.2. CUPACLAD® 201 System *Vanguard*

• 201 Vanguard Special clip

CUPACLAD® 201 metal clips are produced in AISI 316 (A4) stainless steel.

The stainless steel clips have flanges that work just like a spring absorbing differences in the thickness of the slates resulting in a perfect level surface.

• 201 Vanguard horizontal profile

The horizontal profile for CUPACLAD® 201 Vanguard is a patented system for ease of installation of our slates, manufactured from 6060-T6 aluminium alloy. The horizontal rails must be perfectly level as their positioning will define the final alignment of the slates.

The upper side of the profile features rectangular fixing slots positioned every 5cm to house the clips (screws are not required). With this method the use of chalk marks to position the clips is no longer required.

• CUPACLAD® 201-V top profile

For circumstances that require the use of a top section with concealed fixing, a special top profile is needed. Made of aluminium alloy 6060 -T6, natural slate is then fixed by a rivet or self-drilling screw.

c. Secondary substructure

• Metal brackets

Metal brackets are required for fixing the metal profile to the supporting wall. This allows adjustment of the distance between the substructure and the supporting wall to compensate for any irregularities and allowing the use of an insulation material behind the air cavity if specified.

Two different types of brackets must be used in order to achieve optimal installation:

- *Fixed point bracket*: Should be secured to the solid structure of the building in order to resist vertical weight and horizontal wind loads. The vertical profile is secured to the fixed-point bracket using the round holes.

- *Sliding point brackets*: Sliding point brackets secure the remaining length of the vertical profile to the wall using elongated holes, to allow movement due to the thermal expansion of aluminium.

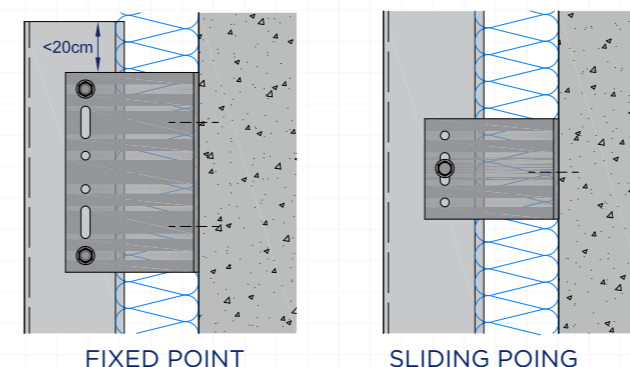

The metal brackets, made of aluminum alloy are installed in alternate courses on either side of the profile.

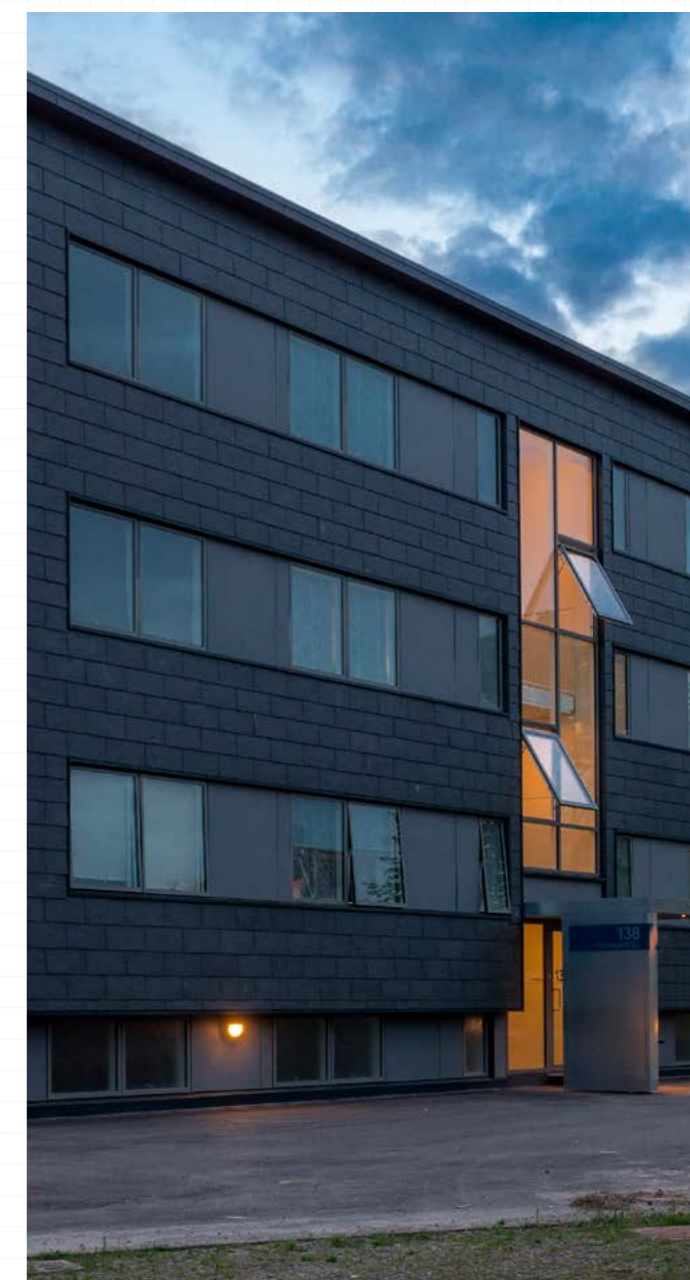
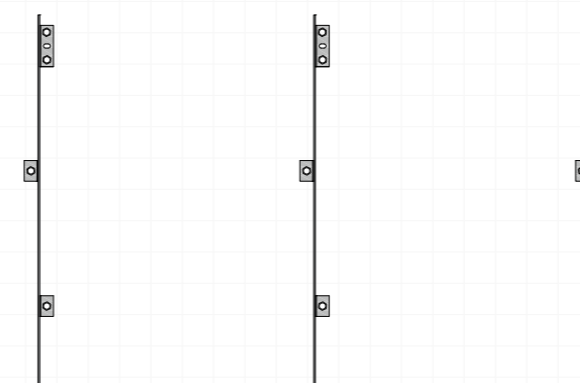

The dimension of the metal bracket will depend on the thickness of the insulating material to be installed in each case and the spacing between should be specified for each project.

The fixings used for the wall brackets must be specified on a project basis by the manufacturer who will take into consideration the characteristics and detail of the supporting wall and the exposure on site.

• Vertical L profile

The "L" shaped 60x50x2 vertical rails manufactured from 6060-T6 profile aluminium alloy supplied in 6m lengths. The gap between the vertical rails must be clarified on a project basis taking into account the following variables (the exposure of the site - height of the building, location, distance from the sea...).

The vertical rails must be perfectly level before they support all the other components of the system.

d. Screws

The joints between the vertical profiles, the metal brackets and between the horizontal and vertical profiles, will be secured with rivets or stainless steel screws A2 (Ø5,5 mm).

Horizontal profiles must be fixed to the vertical profiles in each intersection. In areas where two consecutive horizontal profiles meet, the following must be taken into consideration:

- The end of each batten must have its own fixing.
- Allow a gap of 3mm between both profiles.

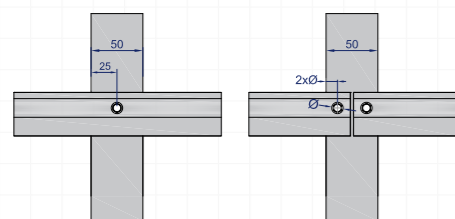

e. Air cavity

The substructure must allow for an air cavity between the insulation and cladding material. For optimal air circulation the cavity must:

- Allow minimum of 2cm width in the narrow areas.
- Both ventilation inlet and outlet must allow enough air circulation. In order to calculate it we must take into consideration the dimensions of the ventilation openings at the top and bottom of the cladding (measured in cm² per lineal meter of cladding). They should be at least:

Building height (m)	Minimum surface for ventilation(cm ² /ml)
≤ 3m	50
de 3 a 6m	65
de 6 a 10m	80
de 10 a 18m	100
de 18 a 24m	115

At the first course of the cladding, the opening at the inner channel must include a ventilated profile that also incorporates a mesh to prevent the entry of insects & small mammals.

f. Insulation material

There are various types of insulation on the market suitable for ventilated claddings. The nature and thickness of the insulation must be carefully calculated on an individual project basis taking into account the varying factors (type of building, location and exposure...).

g. Waterproof Membrane

For timber buildings it is advisable to cover the supporting wall with a waterproof membrane. It is important to ensure the membrane is perfectly fixed and will not cause any obstruction for correct ventilation.

h. Flashings

Flashings can be produced in galvanized steel, aluminum or zinc, and are used for edges, window frames and other sections of the cladding.

i. Load bearing wall

The supporting wall must ensure the stability of the building. The wall must be sufficiently stable to support not only the weight of the cladding but also take into account the wind loads transmitted through the substructure.

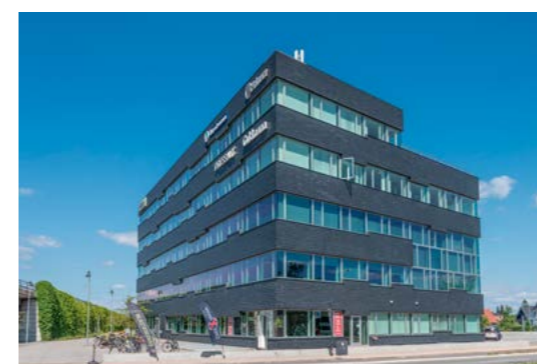
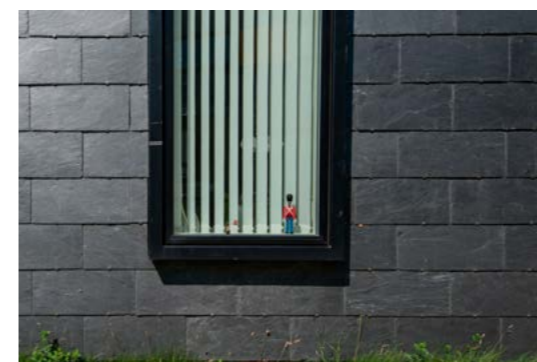

CUPACLAD®
TECHNICAL ADVICE

CUPA PIZARRAS has a technical department dedicated to CUPACLAD®, offering its customers a consultancy service to help specify the project, ensuring the highest quality and commitment to provide the most appropriate solutions for every requirement.

We inspect the plans to produce a detailed specification and recommend the most suitable system for any individual project. Not only that, we go one step further by offering tailor made solutions for every requirement a certain project may have.

Our technical department is also responsible for the coordination of the sales, marketing and production activities to ensure the maximum quality of the material to be supplied.



CUPACLAD® stands for personalised attention

You can contact our technical department on CUPACLAD.com or cupaclad@cupagroup.com





The quality of our product lies in our total control of the entire production process (from extraction to shipment) and by putting in place the highest quality and environmental policy requirements demanded by ISO 9001 Quality and ISO 14001 Environmental certifications.



Our strength of commitment to quality has earned us the confidence of thousands of architects, contractors and clients worldwide.



CUPA PIZARRAS

The world leader in natural slate

With more than a century of experience CUPA PIZARRAS has become the world leader in natural slate production sales and marketing . We strive to keep ourselves in this privileged position by focusing on quality, investing in innovation and our commitment to sustainable growth.

One in every three slates used throughout the world is a CUPA PIZARRAS natural slate. Our 16 quarries and 22 processing facilities combine the latest technology with our traditional know-how and craftsmanship.

Our thorough inspection during the entire production process, from extraction to processing prior to shipment, allows us to produce unique natural slates, recognized worldwide for their quality.

Today we export over 98% of our production to 60 countries on 5 continents.

CUPA PIZARRAS is part of the CUPA GROUP, 65 companies whose mission is to offer innovative building solutions with natural materials.

A modern building with a dark grey, textured facade and large windows. The building is partially obscured by a dark blue overlay containing text. The background shows a clear blue sky and some greenery in the foreground.

CUPACLAD

Ph. 866-421-1171
cupaclad@cupapizarras.com
www.cupaclad.com

DISTRIBUTED BY:

TAYLOR MAXWELL

Taylor Maxwell House
The Promenade
Clifton, Bristol, BS8 3NW
enquiries@taylor.maxwell.co.uk
Ph. 0203 794 9377
www.taylormaxwell.co.uk