



*Jaymart*

**Aluminium  
Entrance  
Matting  
Systems**





A nighttime photograph of a city skyline with several illuminated skyscrapers. The lights from the buildings are reflected in a body of water in the foreground. The sky is dark, and the overall scene is lit up by the city lights.

Jaymart Rubber & Plastics Ltd was founded in 1967 and has supplied mats throughout the UK, Europe and the world.

We have a vast range of products that can be customised for every application imaginable.

We provide expert analysis and advice in creating a safe, attractive and vibrant matting system to any entrance for any building.

Service, quality and reliability are the foundations of our business.

Jaymart Entrance Matting Systems offer up to date designs and colours to make an entrance of any building.

Our aluminium profiles are the heaviest on the market and can perform in the most demanding of applications, keeping dirt and moisture from entering the building, reducing cleaning costs, risk of slip/ trips and falls and protecting expensive internal floor finishes.

Jaymart have over 55 years experience of advising on the right entrance matting system for your building

# Make an entrance and the right first impression with Jaymart entrance mat systems



Healthcare



Commercial



Retail

The entrance to a building has to be pleasing aesthetically and functional - able to remove dirt and moisture from traffic entering a building, helping to reduce cleaning costs, reduce the use of harmful cleaning chemicals and increase the lifespan of the internal floorcoverings reducing the amount of damaged or worn flooring to landfill. The Jaymart entrance mat systems are suitable for every type of building able to compliment any entrance or make a feature whilst doing the important work of keeping dirt out.

We offer luxurious and prestigious systems that make a statement to more modest but effective sheet matting options used in the aluminium mat scraper rails so you can co-ordinate zonal matting or as standalone matting. There is a Jaymart mat for every entrance on every type of building.



Leisure



Education



Transport



Hotels



Shopping Centres





*Jaymart*

#### Key Features

- They trap up to 90% of dirt and moisture, therefore reducing cleaning costs and use of harmful cleaning chemicals
- They help to protect the expensive floor finishes reducing the amount sent to landfill..
- The panel construction, which allows for rib alignment between panels, renders them stronger than wired construction types which can snap or bend. This also facilitates replacement of insert strips in the unlikely event of damage or desire to change colour scheme. Leading to a useful lifespan of 30 years when refurbished.
- This also allows for more elaborate designs to be incorporated if required.
- The Insert materials can be customised to maximise performance of the product and if required to make a statement upon entering the building.
- Logos can easily be incorporated into the mat at very reasonable costs.
- They can be surface mounted or installed in a recessed matwell.
- The mats incorporate 100% Recycled Aluminium and are also easy to recycle after useful life, and so are an environmentally friendly product.
- Now can be anodised in colours including antique bronze and black.
- 10 year warranty.



# Why Use Entrance Matting ?

Entrance matting is an important component of building maintenance as it helps prevent soil and moisture from being tracked inside. This not only helps keep floors and carpets clean, but also improves indoor air quality, reduces slip and fall hazards, and extends the life of flooring materials.

There are a variety of types of entrance matting, including recessed matting, surface-mounted matting, and modular tile systems. Each type has its own advantages and is best suited for different applications.



## Increase in Public Safety

Nearly 90% of slip accidents happen when floors are wet or contaminated

An effective entrance matting system can reduce the risk of slips and falls whilst helping to stop the ingress of moisture and soil into a building by up to 90%



## Removes Dirt & Moisture - Reducing Cleaning Costs

For every 1kg of soil ingressed into a building it is estimated that it costs approx £720 per Kg to remove it.

An effective entrance matting system can reduce significant ingress of soil into a building reducing cleaning costs and potential use of cleaning chemicals - which could impact the environment.



## Protects Internal Floor Finishes

Every visitor to a building will ingress dirt and moisture - if it ingresses on to the expensive floor finishes inside the building it costs money to remove it and also could damage the floor finishes.

An effective entrance matting can provide an effective barrier matting to foot borne dirt and moisture - preventing premature damage, extending its lifespan and reducing the need to replace expensive internal floor finishes



## Creates The Right First Impression

Does the entrance/ reception area give the right first impression of your business and services?

The right entrance matting can help create the right first impression as it is the first point of contact visitors have with your building. This can help by making sure reception and public areas are safe clean and look attractive.



## Environmental Impact & Sustainability

Our Products Use 100% recycled aluminium and can be recycled after use making our aluminium mat products very environmentally friendly. This combined with the ability to replace the insert material rather than replacing the whole mat, means that although not directly eligible for BREEAM Credits selecting Jaymart will help in supporting your BREEAM certification.

We manufacture in the United Kingdom to precise specifications/ measurements. This means Jaymart can reduce waste and transport.

Our products are extremely Hard wearing and will reduce the need for frequent replacement to support BREEAM MAT 05 criteria and also minimise the use of harmful cleaning chemicals and cleaning/ maintenance costs for the end user.

BREEAM MAT 01 addresses the environmental impact through the life cycle of the product. The Jaymart aluminium entrance matting system have the ability to refurbish rather than replace means that our products can further support your aims. It will also help with meeting BREEAM MAT 06 requirements. We can also offer products made from natural inserts from sustainable sources to further meet environmental aims. The expected useful lifespan when refurbished is 30 years approximately dependent on wear and correct maintenance being carried out.



Manufactured in United Kingdom



100% Recycled Aluminium



100% Econyl Recycled Nylon Yarn

ECONYL® Regenerated Solution Dyed Nylon is produced using nylon waste which is recovered from oceans and from landfill. Waste such as fishing nets, fabric scraps, carpet and industrial plastic is recovered, sorted and cleaned. Through a regeneration and purification process, the nylon waste is recycled back into its original purity. ECONYL® Regenerated Solution Dyed Nylon is processed into carpet yarn and used to manufacture several of our matting ranges.









# Choosing The Correct Entrance Matting

Consider the Application, the volume and the type of traffic entering the building. Also give consideration to the internal floor finishes for example a ceramic or LVT tile will require a matting insert with a higher rate of absorption to help prevent slip trips and falls.

## Foot Traffic



Heavy

Approx 5000 crossings per day

Example Applications - Railway Stations, Stadiums, Airports, Shopping Centres, Large Hospitals, Department Stores and Supermarkets



Medium

Approx 500 crossings per day

Example Applications - Offices, Hospitals, Schools, High Street Shops & Hotels

## Examples of Wheeled Traffic



Extreme

250kg point load



Forklift Truck



Cherry Picker



Heavy

150kg point load



Pallet Truck



Retail Cage



Medium

100kg point load



Shopping Trolley



Sack Truck



Baggage Trolley



Light

50kg point load



Shopping Trolley



Suitcases



Wheelchair

Please Note:

Illustrations are for guide information only. See product information on individual products applications.



# Type & Performance Of Matting System

**Primary Barrier Matting** - This is first point of contact, used both externally and internally dependent on mat type and application. Available in a choice of gauge to suit matwell depth or for surface mounting. (See zones 1 & 2) Primary barrier matting is usually supplied as a made to measure solution, helping to reduce waste. Consideration should be given to insert material that is suitable for the application. For example use a non-absorbent material or suitable insert that will not become sodden in an external application. Can be customised for specific projects & applications. Please consult us for more advice.

**Secondary Barrier Matting** - is made from high performance textiles and is often used in conjunction with a primary matting solution to provide additional performance. Secondary barrier matting can be used as a stand-alone solution in some circumstances as well as in other areas of a building such as circulation areas. See Zones 3 & 4

**Open Construction** incorporates gaps between the aluminium scraper sections allowing dirt and moisture to fall through in to the matwell below which can be lifted intermittently to remove the debris as well as for deep cleaning the mat itself. Please note regular maintenance must be carried out to prevent mat becoming inefficient. Useful for external applications or for where drainage is necessary.

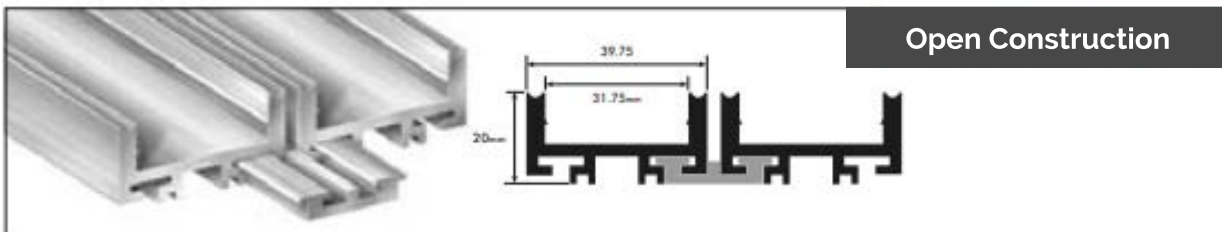

**Closed Construction** allows dirt and moisture remain on the surface of the mat and can be removed by regular cleaning in addition to periodic deep cleaning of the mat itself.

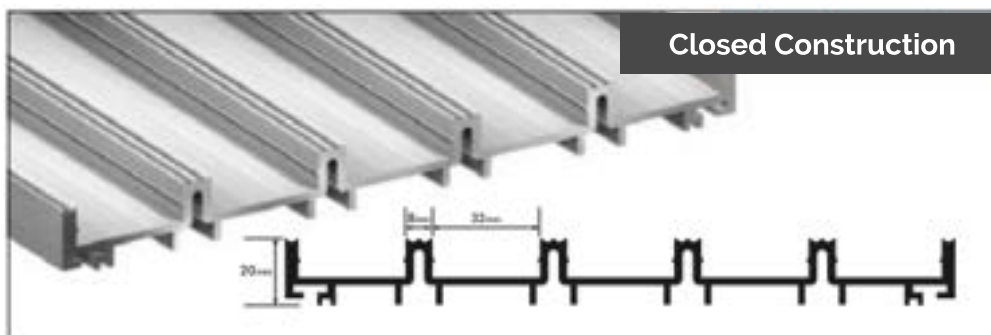

# How much matting is needed?

Consideration should be given to the amount of entrance matting required at the design stage as amending this after installation will be inconvenient and costly.

**Width** - matting should cover the entire entrance of a building, including side entrances so that traffic cannot enter without passing over the mat.

**Length (Front to Back)** - critical to the function of the mat the length will vary dependent on volume of traffic crossing the mat along with consideration to peak times of traffic flow.

HSL (Health & Safety Laboratory) and EFSA (Entrance Flooring Systems Association) have provided the following guidance based on peak flow rates per hour.

Volume Of Traffic (Application)	Number Of People Per Hour	Minimum Length (Front to Back)
Low	78	3 - 4 Metres
Medium	400	6 - 7 Metres
High	800	8 - 10 Metres

## Please note

It is not always possible to install the correct required amount of primary entrance matting. In these circumstances consider using a hybrid insert product to optimise performance or use a secondary barrier mat sheet material in conjunction with the primary entrance matting system. For more information please consult Jaymart.

# Matwell Sizing

Visitors hardly ever stop and wipe their feet in a commercial environment so getting the right size matting is critical. Getting as many steps as possible on the entrance matting helps to reduce the ingress of dirt and moisture into a building.

Every building has different types of traffic and volume. Once this is understood and the most appropriate entrance matting system selected for use, the next consideration is size of the entrance matting system.

The entrance to the building is also where first impressions of a business or organisation is created, an entrance mat can form part of this image statement. Jaymart's range of entrance matting systems allow you to make an incredible design statement as well as comply with BS8300 and BS7953.

**MINIMUM 2100 mm**

**BS 7953 minimum recommendation 2100 mm**

This will allow for a wheel chair full rotation on the matting (based on a standard 26" wheelchair wheel)

**Well Standard 3000mm**

**Well Standard minimum recommendation 3000mm**

The AIR concept states that, 'All regularly used entrances to the building that have pedestrian traffic to the exterior should use an entryway system composed of grilles, grates, slots or roll out mats that are at least the width of the entrance and extend 3 m [10 ft] in the primary direction of travel.

**Optimal recommendation 5500mm +**

**Optimal recommendation 5500mm +**

Depending on the application / factors involved in entrance area / volume of traffic/ type of traffic and flow (Please see other consideration section for more information on what to consider)



# Our 4 step process to a cleaner environment

1

The best way to keep your premises clean is to stop dirt from even getting through the front door. Effective exterior matting scrapes clean and wipes dry, leaving the worst dirt and grit outside, and allowing subsequent interior matting to clean even better.

2

Working in a similar way to exterior matting, this is similarly tough and durable matting that carries on the work to remove the last of the most damaging soil and grit, and continue the drying process.

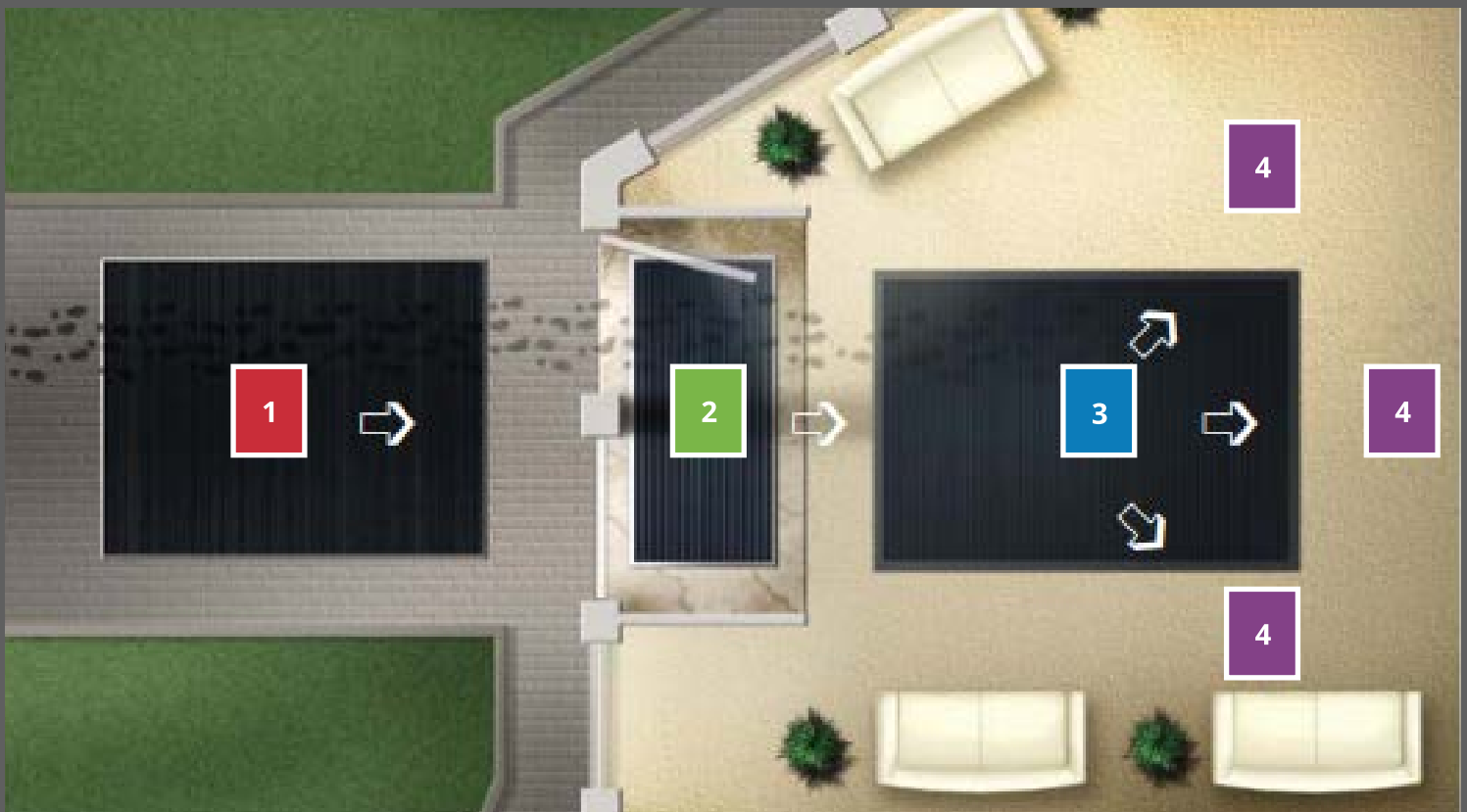

3

With the worst of the damp and debris now dealt with, secondary internal matting is a high-specification, high-performance product that finishes the dusting and drying

4

The foyer is one of the highest traffic areas in your building so, however effective your entrance matting, easy to clean, highly durable and attractive carpet that always looks its best will help you make a great first impression – every time.

System	External Stage 1	Internal Stage 2	Internal Stage 3	Internal Stage 4
Street King	✓	✓		
Street Beater	✓	✓		
Alligator Track	✓	✓		
Alligator Raincheck		✓		
Alligator New Raincheck		✓		
Alligator Raincheck Fleck		✓		
Alligator Forefront	✓	✓		
Alligator Trapper	✓	✓		
Alligator Interzone	✓	✓		
Alligator Warcord	✓	✓		
Alligator Dirtcheck		✓		
Grime Raincheck		✓		
Grime New Raincheck		✓		
Grime Raincheck Fleck		✓		
Grime Grabber	✓	✓		

Please see individual product information for more details

System	External Stage 1	Internal Stage 2	Internal Stage 3	Internal Stage 4
Grime Trapper	✓	✓		
Grime Stopper	✓	✓		
Grime Warcord	✓	✓		
Grime Dirtcheck		✓		
Grime Track	✓	✓		
Grime Design		✓		
Grime Capra		✓		
Raincheck		✓	✓	✓
New Raincheck			✓	✓
Raincheck Fleck			✓	✓
Ingenius			✓	✓
Contract King			✓	✓
Dirtcheck			✓	✓
Warcord			✓	✓
Textra			✓	✓

Please see individual product information for more details



System	External Stage 1	Internal Stage 2	Internal Stage 3	Internal Stage 4
Zigazaga			✓	✓
Brush Well			✓	✓
Polyrib			✓	✓
Symphony			✓	✓
Kum Kleen			✓	✓
Supertwist			✓	✓



Please see individual product information for more details



# CPD SEMINAR

## Entrance matting systems

How to create a safe and welcoming entrance area

### Learning Objectives

- ✔ Be aware of potential issues and hazards
- ✔ Understand how type of traffic, volume of traffic affects entrances
- ✔ Understand different floors need different types of matting
- ✔ Understand different construction/ types of entrance mats
- ✔ Understand regulations and impact on specification
- ✔ Understand how entrance matting can reduce costs, improve safety, help with sustainability and environmental credentials of a building



### Delivered in a convenient way

In Person or by online article

Jaymart can deliver your cpd in person at your premise, online live CPD or an online cpd article at your convenience.





A Lunch & Learn seminar is an informal opportunity for Jaymart to bring an exhibition of products directly to you.

Sessions are designed to be flexible and informative and they can be arranged at a time and date to suit you. They typically last around 2 hours and in this time people drop in as they wish.

Jaymart personnel are available to discuss our products generally or address specific requirements.

They are often booked over lunch time and we are happy to work with you to provide lunch or if you prefer a different time, a variety of snacks.

Call to book please call 01985 218994 or email [sales@jaymart.co.uk](mailto:sales@jaymart.co.uk)

**Jaymart have a number of free resources available from short but informative in person presentations available for practices with lunch; online CPD articles that can be completed with the minimum of fuss, at a time that suits; and our free specification guide on how to specify entrance matting.**



Jaymart also offer an online CPD Article via Barbour Product Search. Please click link to the left to access this non intrusive way of getting CPD points.



To download our specification guide for entrance matting please click the Jaymart logo to the left to download this resource.



# Product Ranges



# The STREET range

The STREET range of jaymart prestigious aluminium entrance matting systems has long been established as a high quality product for extremely heavy duty applications. The STREET range is specifically designed to withstand extremely heavy footfall and wheeled traffic. Ideal for applications where performance under the severest of traffic conditions is required. Airports, Shopping Centres, Department Stores, Exhibition Centres, Universities, Racecourses and hospitals

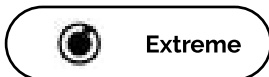
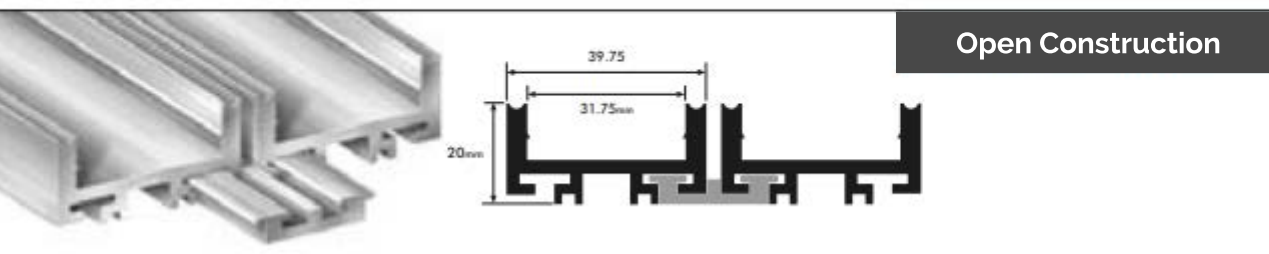
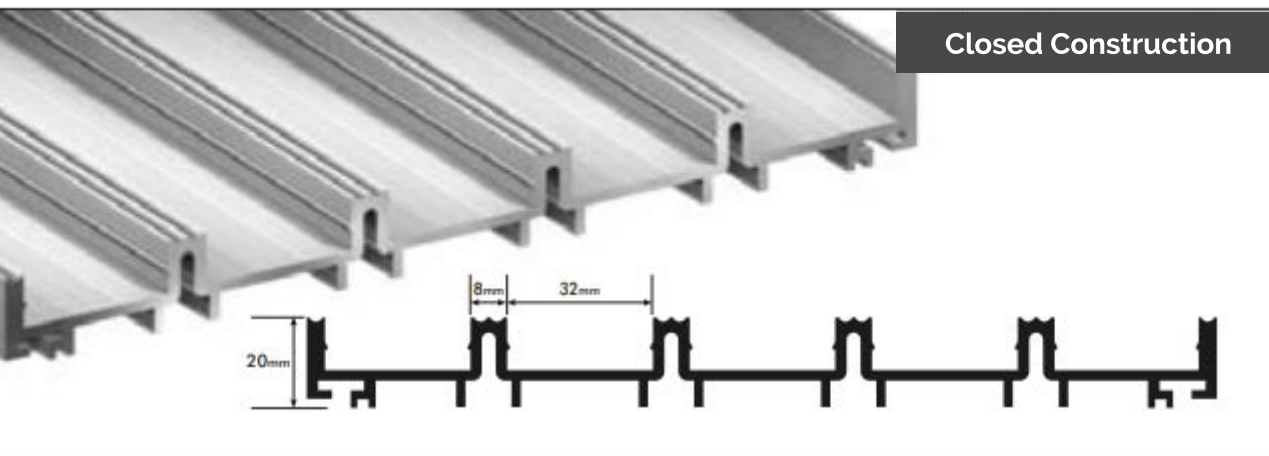

250kg point load

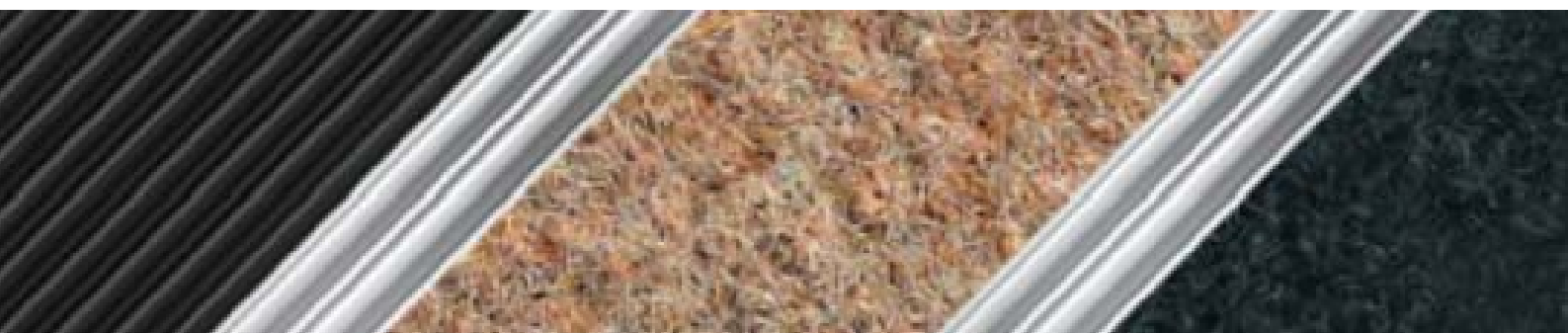
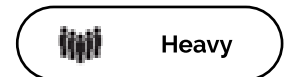





# STREET King

Street King is an extremely popular internal / external very heavy duty contract aluminium entrance matting. Street King combines alternating aluminium ridged scraper sections for optimal resistance and moisture draw off with channeled Contract King super heavyweight fibre bonded polypropylene specialist dirt barrier matting. Supplied in closed construction as standard, we recommend open construction for external or partially covered areas.

Street-King matting is designed for use in indoor and outdoor entrances such as airports, shopping centres, railway stations, shops, public buildings, schools, offices, hotels, leisure centres, banks and hospitals.

22mm Closed and Open Construction

Internal and External Sheltered applications



Purple



Royal Blue



Anthracite



Emerald Green

# STREET Beater

Street Beater comprises of strips of 12mm fine ribbed rubber inserted into alternating ridges aluminium scraper channel sections.

Street Beater can be used as either indoor or an outdoor entrance matting. Available in closed or in heelsafe open construction. Replacement strips are available should they be required.

Street-King matting is designed for use in indoor and outdoor entrances such as airports, shopping centres, railway stations, shops, public buildings, schools, offices, hotels, leisure centres, banks and hospitals.

21mm Closed and Open Construction

Internal and External Exposed / Sheltered applications



Black Only



Please click here to see technical information on STREET King



22mm  
CLOSED



Please click here to see technical information on STREET Beater



21mm  
CLOSED



Alligator Raincheck HSBC Birmingham

# The ALLIGATOR range

The ALLIGATOR aluminium entrance mat systems are a highly prestigious fine ribbed protection entrance matting. Alligator provides a more aesthetic approach to entrance matting, combining colourful, texturally decorative yet consistently effective insert materials with aluminium scraper sections.

The ALLIGATOR system entrance matting is designed to keep dirt and grime outside and will simultaneously enhance the appearance of the entrance to buildings they protect.

The ALLIGATOR range's applications include schools, offices, universities, theatres, surgeries, art galleries, museums, airports and shopping centres.

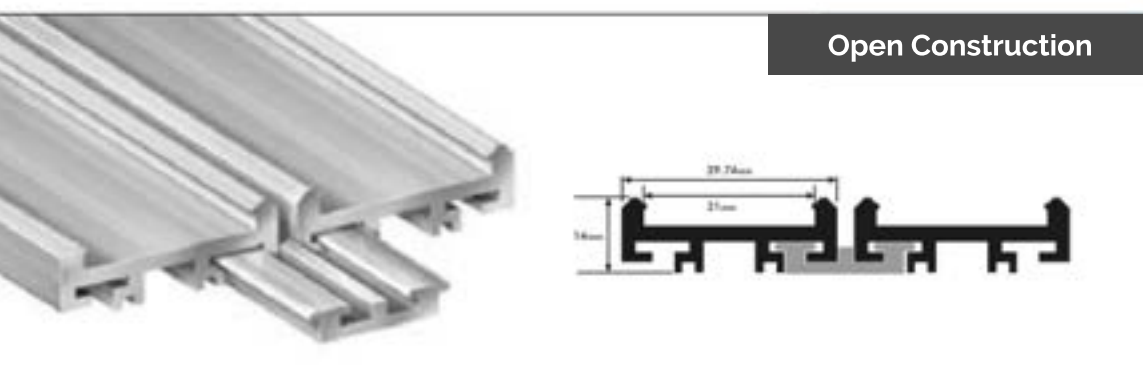
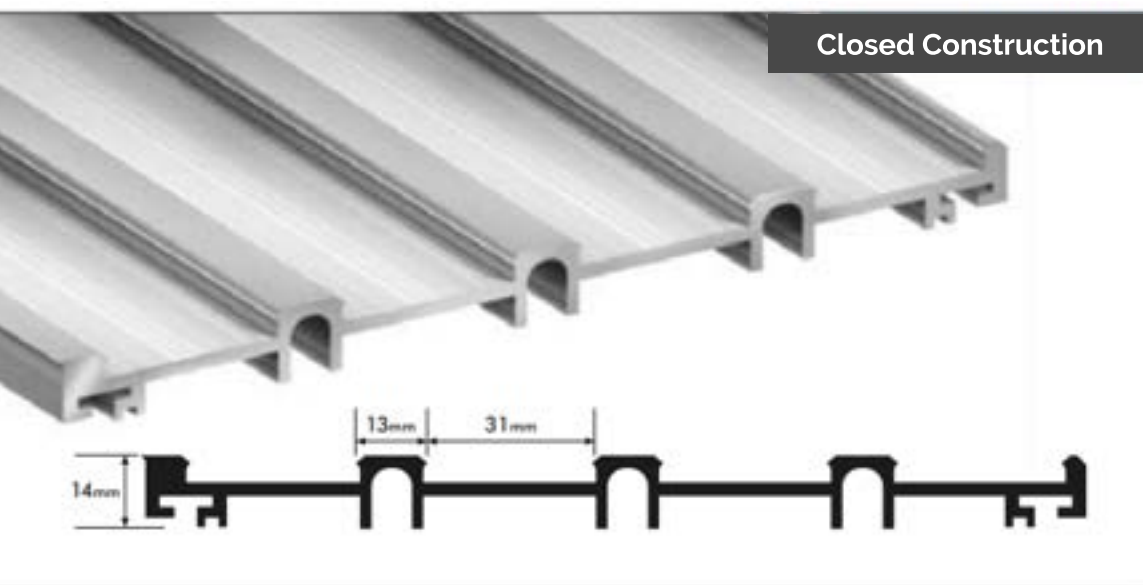

150kg point load



# ALLIGATOR Raincheck

Alligator Raincheck combines the many superior soil containment and colour option properties of Raincheck super heavy contract Econyl - regenerated Nylon on vinyl clean zone barrier matting with alternating prestigious elegant and extra hard wearing aluminium fine fluted scraper sections.

The Alligator Raincheck is available in heel safe choice of standard closed or open construction - suitable for wheeled traffic

Alligator Raincheck 17.5mm Open and Closed construction

Interior Applications

PLEASE NOTE WHILST STILL AVAILABLE - NOW BEING REPLACED WITH OUR NEW RAINCHECK INSERTS - WITH IMPROVED WEAR AND PERFORMANCE SEE ALLIGATOR NEW RAINCHECK



**ECONYL®**

# ALLIGATOR Raincheck

Alligator Raincheck combines the many superior soil containment and colour option properties of Raincheck super heavy contract Econyl - regenerated Nylon with monofilament micro brushes to improve performance on vinyl clean zone barrier matting with alternating prestigious elegant and extra hardwearing aluminium fine fluted scraper sections.

The Alligator Raincheck is available in heelsafe choice of standard closed or open construction - suitable for wheeled traffic

17.5mm Open and Closed Construction

Internal Applications

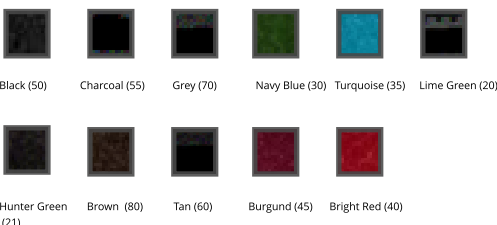

**ECONYL®**



Please click here to see technical information on ALLIGATOR Raincheck

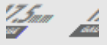

Please click here to see technical information on ALLIGATOR NEW Raincheck







# ALLIGATOR Raincheck Fleck

Alligator Raincheck Fleck combines the many superior soil containment and colour option properties of Raincheck with a subtle fleck design -super heavy contract Econyl - regenerated Nylon with monofilament micro brushes to improve performance on vinyl clean zone barrier matting with alternating prestigious elegant and extra hardwearing aluminium fine fluted scraper sections.

The Alligator Raincheck Fleck is available in heelsafe choice of standard closed or open construction - suitable for wheeled traffic

17.5mm Open/ Closed Construction

Internal Applications



Black /  
Charcoal  
(51)

Charcoal/  
Grey  
(56)

Grey  
Charcoal  
(71)

Brown  
Fleck  
(81)

Tan  
Fleck  
(60)

**ECONYL**<sup>®</sup>

# ALLIGATOR Dirtcheck

Alligator Dirtcheck combines superior abrasion for soil containment and high absorption of moisture with super heavy contract Econyl - regenerated Nylon on vinyl clean zone barrier matting utilising mono-filament brushes within the pile with alternating prestigious elegant and extra hard wearing aluminium fine fluted scraper sections.

The Alligator Dirtcheck is available in heel safe choice of standard closed or open construction - suitable for wheeled traffic

17.5mm Open / Closed Construction

Internal Applications



Black Stripe    Charcoal Stripe

**ECONYL**<sup>®</sup>



Please click here to see technical information on ALLIGATOR Raincheck Fleck



Please click here to see technical information on ALLIGATOR Dirtcheck





Merry Hill Shopping Centre, Dudley





# ALLIGATOR Interzone

Alligator Interzone is a multi directional chevron ribbed 100% polypropylene barrier matting with fine ribbed aluminium scraper channels/

Alligator Interzone is a made to measure supremely attractive, effective and very hard wearing entrance matting system. Combining replaceable strips of Zigazaga proven for 40 years multi-directional chevron ribbed polypropylene barrier matting and elegant aluminium scraper channels .

17mm open and closed construction

Internal/ External Sheltered Applications.



Nightshadow Goblin Grey Raw Umber Burnt Brick Ancient Red

# ALLIGATOR Forefront

Alligator Forefront is a made to measure superbly effective, and very hardwearing entrance matting suitable for all commercial and public buildings.

It combines the proven advantages of alternating aluminium scraper sections with replaceable exclusive extra heavy duty polypropylene brush/ dirt control matting.

Available in a choice of popular colourfast colours and both heelsafe "open" construction (recommended for outdoor or excessively wet areas) and standard "closed" construction.

Can incorporate logos and designs - please ask for technical assistance.

20mm Open / Closed Construction

Internal/ External Applications



Tan (05) Yellow (98) Orange (99) Bright Red (42) Bright Green (21) Brown (82)



Bright Blue (34) Navy Blue (36) Grey (71) Granite (27) Slate (77) Black (00)

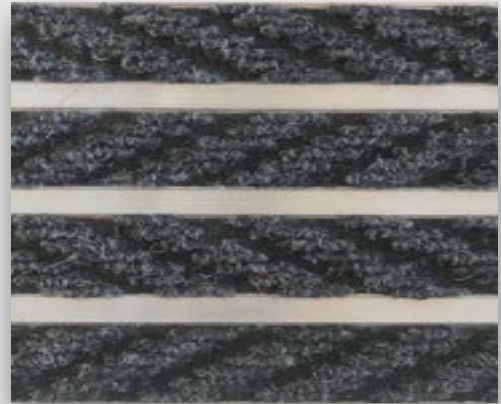

Please click here to see technical information on ALLIGATOR Interzone



Please click here to see technical information on ALLIGATOR NEW Raincheck







# ALLIGATOR Trapper

Alligator Trapper is a multi directional Studded Design 100% polypropylene barrier matting with fine ribbed aluminium scraper channels/

Alligator Trapper is a made to measure supremely attractive, effective and very hard wearing entrance matting system. Combining replaceable strips of Textra multi-directional studded design polypropylene barrier matting and elegant aluminium scraper channels .

17mm open and closed construction

Internal / External Sheltered Applications



Nightshadow Gobelin Grey Raw Jeans Raw Umber Mahogany Brown Ancient Red

# ALLIGATOR Warcord

Alligator Warcord is a heavy duty entrance matting system designed for internal and sheltered external high traffic applications. Combining micro ribbed polypropylene cord entrance matting with alternating aluminium scraper sections.

Alligator Warcord is ideal for schools, libraries, Shops, Stations and commercial buildings where optimal dirt and moisture removal is essential.

PLEASE NOTE RANGE IS BEING UPDATED - PLEASE CHECK ON COLOUR SELECTION TO ENSURE WE CAN MEET YOUR REQUIREMENTS

15mm open and closed construction

Internal/ External Sheltered Applications

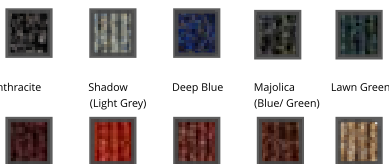

Anthracite Shadow (Light Grey) Deep Blue Majolica (Blue/ Green) Lawn Green Grape Scarlet Red Earth Earth Brown Beige



Please click here to see technical information on ALLIGATOR Trapper

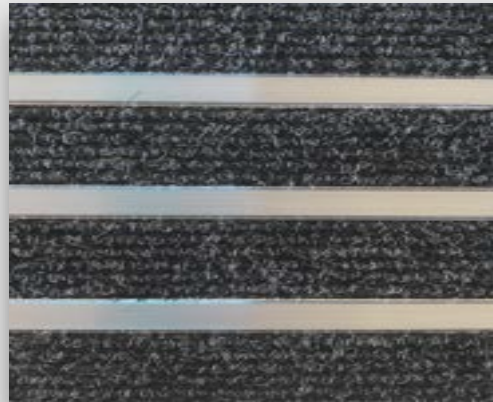

Please click here to see technical information on ALLIGATOR Warcord





# ALLIGATOR Track

Alligator Track combines micro-ribbed aluminium scraper sections with fine fluted rubber inserts for a primary entrance matting system to scrape dirt, mud, moisture and other debris to most public and commercial buildings. Typical applications are railways stations, bus stations, shopping centres and leisure centres

15mm open and closed construction

Internal / External Applications



Black Only

# ALLIGATOR Rib

Alligator Rib utilises a thick set ribbed 100% polypropylene barrier matting with fine ribbed aluminium scraper channels for optimal cleaning.

Alligator Rib is a made to measure supremely attractive, effective and very hard wearing entrance matting system. Combining replaceable strips of Jaymart Rib thick set ribbed polypropylene barrier matting and effective fine ribbed aluminium scraper sections.

17mm open and closed construction

Internal / External Sheltered Applications



Tan (05)



Anthracite  
(50)



Closed Construction



Open Construction



Please click here to see technical information on ALLIGATOR Track



Please click here to see technical information on ALLIGATOR rib





# The GRIME range

Jaymart's GRIME range of prestigious aluminium entrance matting systems has proved to be your matting of choice, not only to its smart appearance but also due to its effectiveness in removing dirt and moisture, reducing damage, cleaning and maintenance to internal floorcoverings. Form and Function

The Grime's low profile gauge makes it an ideal choice when using an existing show recess - for example on refurbishment projects, entrance lobbies or when surface mounting using ramped sections.

GRIME range application include commercial premises, office buildings, high street stores, sports and leisure centres, libraries, museums and schools.

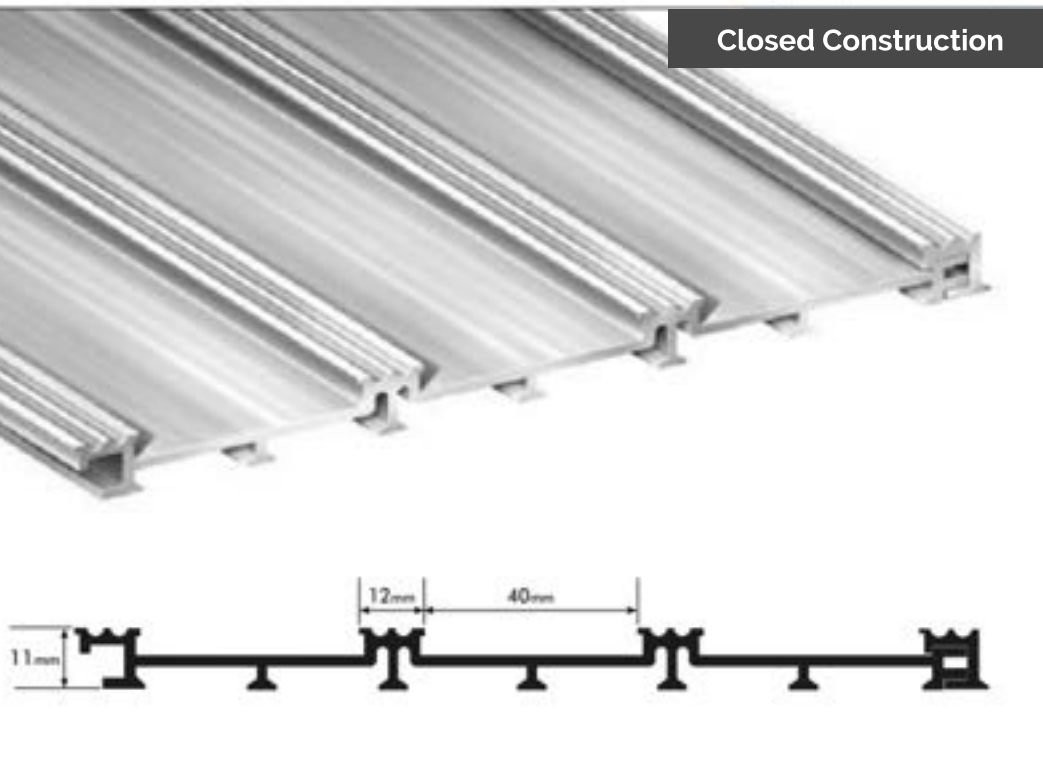

Medium

100kg point load



Medium



# GRIME Raincheck

Grime Raincheck combines the many superior soil containment and colour option properties of Raincheck super heavy contract Econyl - regenerated Nylon on vinyl clean zone barrier matting with alternating and extra hard wearing aluminium ridged scraper sections.

Grime Raincheck is available in heelsafe closed construction - suitable for wheeled traffic

15mm Closed Construction

Internal Applications

PLEASE NOTE WHILST STILL AVAILABLE - NOW BEING REPLACED WITH OUR NEW RAINCHECK INSERTS - WITH IMPROVED WEAR AND PERFORMANCE SEE ALLIGATOR NEW RAINCHECK

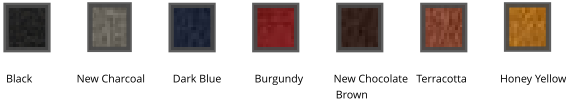

# GRIME NEW Raincheck

Grime NEW Raincheck combines the many superior soil containment and colour option properties of NEW Raincheck super heavy contract Econyl - regenerated Nylon with mono-filament micro brushes to improve performance on vinyl clean zone barrier matting with alternating extra hard wearing aluminium Ridged scraper sections.

The Grime Raincheck is available in heel safe closed construction - suitable for wheeled traffic

15mm Closed COnstruction

Internal Applications

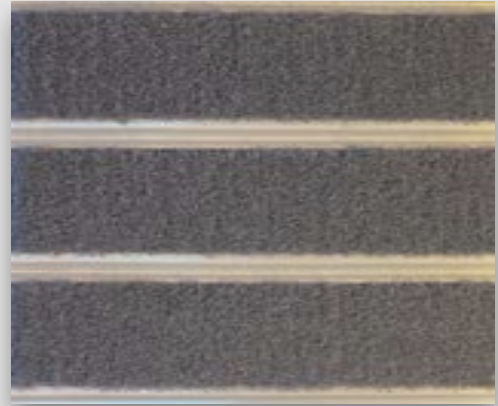
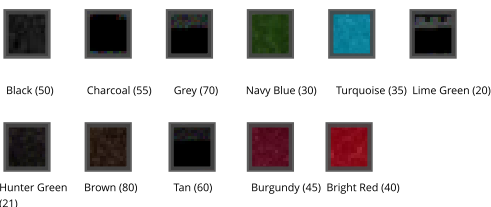

Please click here to see technical information on GRIME Raincheck



Closed Construction Only



Please click here to see technical information on GRIME NEW Raincheck



Closed Construction Only



AUT

Q



# GRIME Raincheck Fleck

Grime Raincheck FLECK combines the many superior soil containment and colour option properties of Raincheck with a subtle fleck design -super heavy contract Econyl - regenerated Nylon with mono filament micro brushes to improve performance on vinyl clean zone barrier matting with alternating extra hard wearing aluminium fine ridged scraper sections.

The Grime Raincheck FLECK is available in heel-safe closed construction - suitable for wheeled traffic

15mm Closed Construction

Internal Applications



Black /Charcoal (51) Charcoal /Grey Fleck (56) Grey /Charcoal (71) Brown Fleck (81) Tan Fleck (60)



# GRIME Dirtcheck

Grime Dirtcheck combines superior abrasion for soil containment and high absorption of moisture with super heavy contract Econyl - regenerated Nylon on vinyl clean zone barrier matting utilising mono-filament brushes within the pile with alternating extra hard wearing aluminium ridged scraper sections.

The Grime Dirtcheck is available in closed construction - suitable for wheeled traffic

15mm Closed Construction

Internal Applications



Black Stripe Charcoal Stripe

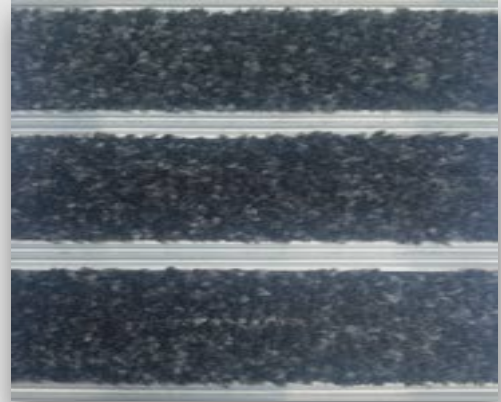

Please click here to see technical information on GRIME Raincheck Fleck



Closed Construction Only



Please click here to see technical information on GRIME Dirtcheck



Closed Construction Only





# GRIME Stopper

Grime Stopper combines the extremely hard wearing, effective drying and scraping properties along the attractive design of Polyrib polypropylene ribbed matting with the added benefits of the ridged aluminium scraper sections.

Can be refurbished with replaceable insert strips at a fraction of the original cost - Highly sustainable

Available in a choice of popular colourfast colours and closed heel safe construction.

**16mm Closed Construction**

Internal/ External Sheltered Applications

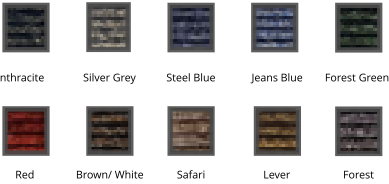

# GRIME Grabber

Grime Grabber is a made to measure superbly effective, and very hard wearing entrance matting suitable for all commercial and public buildings.

It combines the proven advantages of alternating aluminium scraper sections with replaceable exclusive extra heavy duty polypropylene brush/ dirt control matting.

Available in a choice of popular colourfast colours and closed heel safe construction.

Can incorporate logos and designs - please ask for technical assistance.

**17mm Closed Construction**

Internal/ External Applications

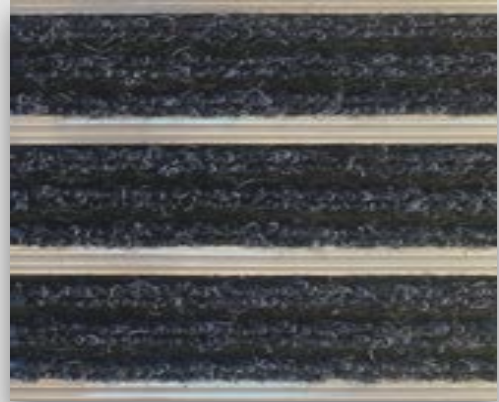

Please click here to see technical information on GRIME Stopper



Closed Construction Only

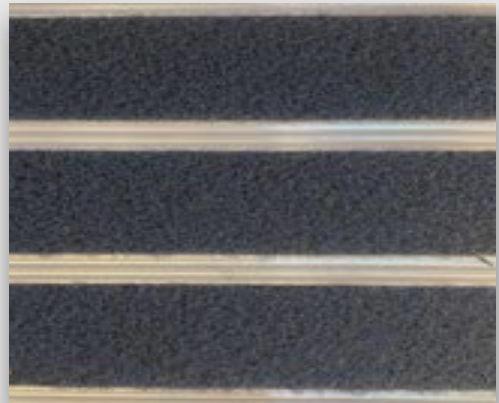

Please click here to see technical information on GRIME Grabber



Closed Construction Only







# GRIME Track

Grime Track is a heavy duty entrance matting system designed for internal and even exposed external high traffic applications. Combining Fine ribbed Rubber entrance matting with alternating aluminium scraper sections.

Grime Track is ideal for schools, libraries, Shops, Stations and commercial buildings where optimal dirt and moisture removal is essential.

Available in 12.5 mm heel safe closed construction

Internal/ External Applications



Black Only

# GRIME Warcord

Grime Warcord is a heavy duty entrance matting system designed for internal and sheltered external high traffic applications. Combining micro ribbed polypropylene cord entrance matting with alternating aluminium scraper sections.

Grime Warcord is ideal for schools, libraries, Shops, Stations and commercial buildings where optimal dirt and moisture removal is essential.

PLEASE NOTE RANGE IS BEING UPDATED - PLEASE CHECK ON COLOUR SELECTION TO ENSURE WE CAN MEET YOUR REQUIREMENTS

Available in 12.5 mm heel safe closed construction

Internal/ External Sheltered Applications



Anthracite Shadow(Light Grey) Deep Blue Majoica(Blue/ Green) Lawn Green



Grape Scarlet Red Earth Earth Brown Beige

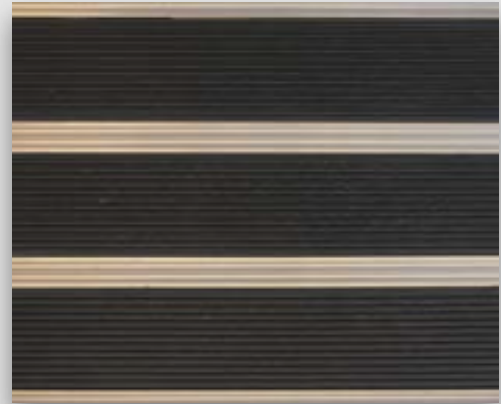

Please click here to see technical information on GRIME Track



Closed Construction Only



Please click here to see technical information on GRIME Warcord



Closed Construction Only



Symphony Hall

# GRIME Trapper

Grime Trapper is a multi directional Studded Design 100% polypropylene barrier matting with ribbed aluminium scraper channels

Grime Trapper is a made to measure supremely attractive, effective and very hard wearing entrance matting system. Combining replaceable strips of Textra multi-directional studded design polypropylene barrier matting and effective aluminium scraper sections.

16mm closed construction

Internal / External Sheltered Applications



Nightshadow Gobelin Grey Raw Jeans Raw Umber Mahogany Brown Ancient Red

# GRIME Rib

Grime Rib utilises a thick set ribbed 100% polypropylene barrier matting with ribbed aluminium scraper channels for optimal cleaning.

Grime Rib is a made to measure supremely attractive, effective and very hard wearing entrance matting system. Combining replaceable strips of Jaymart Rib thick set ribbed polypropylene barrier matting and effective aluminium scraper sections.

16mm closed construction

Internal / External Sheltered Applications



Tan (05) Anthracite (50)



Please click here to see technical information on GRIME Trapper



Closed Construction Only



Please click here to see technical information on GRIME Rib



Closed Construction Only



# Design A. Mats



Jaymarts range of aluminium mat systems can be customised to suit every application to optimise performance with a 2, 3 or 4 stage system or even logos and designs. The entrance mat system can help make a feature of the building, direct traffic through the entrance or just quietly sit there in the background helping to reduce cleaning costs and helping prevent slip, trips and falls whilst helping to create the right first impression to visitors to that building.

For more information and help please contact our technical department

# Design Mat Options

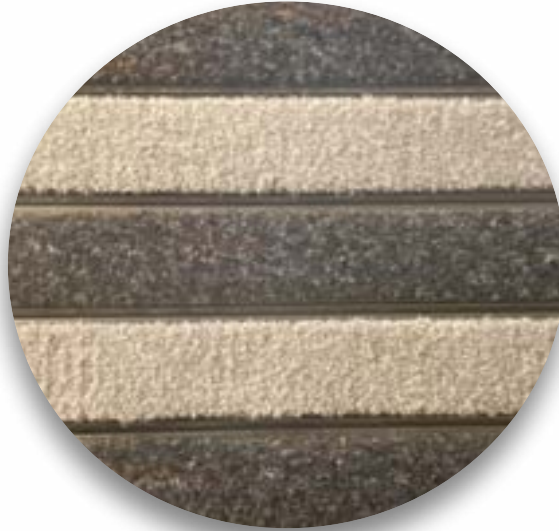

## Stripes

Dirtcheck and Raincheck

From Simple stripes to logos and design to very complicated features and designs, we have the capacity to cater for all design requirements

We can use different materials to offer simple stripes to chevrons

Using a design/ logo you can identify a building incorporate a company logo or even help to direct traffic through a building



Textra

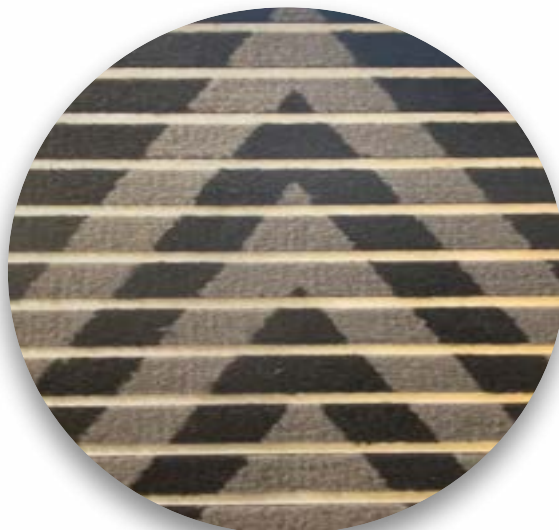

Raincheck

## Designs, Features and Borders



Chevron Design Layout



Border Design

Our aluminum entrance matting system is extruded so allows for designs and features to be incorporated to create a feature entrance mat where the ribs don't have to run left to right but could be laid as chevrons or with a border around the edge. The matting could even be installed to follow the contour of a building. We can work with you to help achieve an entrance that creates a magnificent feature for your entrance.



Aluminium mat following curve of building



Alternating inserts or in stages to optimise performance



## Examples of Designs/ Applications

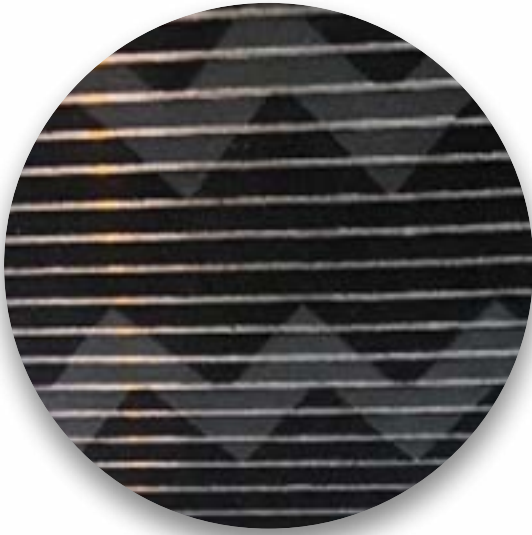

Grime Grabber with  
Ingenius Inserts - Nandos



Textra Sheet Matting - Nandos



Grime Warcord with Tretford  
Goat Hair Insert - Park Regis  
Birmingham

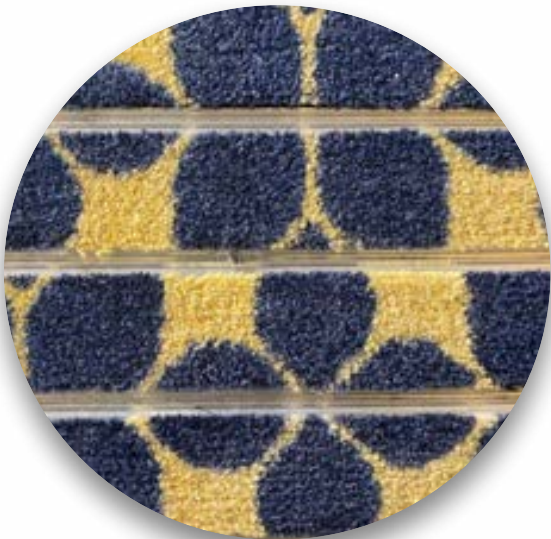

## **Symphony Nylon Twist Designs**

A Hardwearing super absorbent Nylon twist pile that allows us to print the most intricate of designs in a wide variety of colours . The depth and clarity of the designs and colours are breathtaking.

# Anodised Aluminium Profile Sections



Alligator Raincheck Bronze

Our aluminum entrance matting system allow for the aluminum profiles to be anodised. This can be useful where you are looking to match a colour in your design or you are working on a matting in an older building that needs a sympathetic approach to match existing features. Below are our most popular colours but **we can match to most colours required.**



Grime Dirtcheck Black



Bronze



Antique Bronze



Dark Bronze



Black



# GRIME Capra



GRIME Capra is a very sustainable entrance matting consisting of strips of very heavy duty Natural goat hair (Tretford Cord) available in 41 colours secured between rigid silver aluminium scraper bars. Designed for indoor use in shops, public buildings, schools, offices, hotels, leisure centres, train stations, bus stations and hospitals.

Made from the waste from cashmere wool so is a very sustainable option - consult Jaymart for product suitability

15mm closed construction

Internal Applications

Can incorporate logos and designs - please ask for technical assistance.

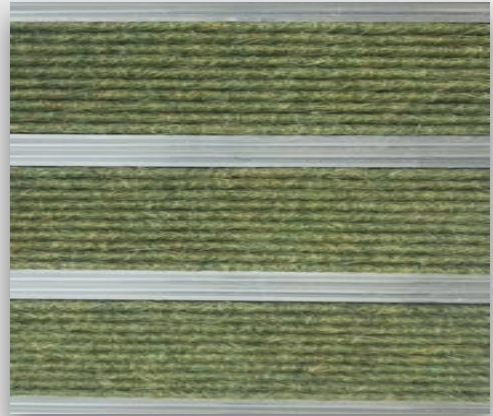

Please click here to see technical information on GRIME Capra

Closed Construction Only









515 Quartz



555 Wild Rice



571 Mushroom



538 Silver Birch



601 Truffle



532 Sisal



512 Dapple Grey



572 Milk Chocolate



573 Tobacco

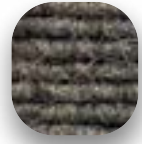

523 Zinc



520 Damson



534 Anthracite



590 Coffee Bean



714 Dark Chocolate



632 Granite



568 Jonquille



585 Orange Squash



570 Strawberry



591 Salmon



564 Amber



560 Curry



588 Rose



524 Russet



559 Burnt Orange



581 Deep Purple



633 Garnet



582 Grapefruit



584 Blackberry



592 Purple



514 Bilberry



517 Riviera

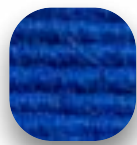

516 Brilliant Blue



575 Cornflower



567 Lagoon Blue



565 Evergreen



566 Lichen



569 Clover



556 Fern



580 Lettuce Leaf



558 Peacock



519 Sage



# GRIME Design

Grime Design is Heavy Duty 3 Ply Nylon Pile - Symphony Rubber backed foyer carpeting in alternating heavy duty ridged aluminium scrapers. Designs and features can be incorporated to almost any design. With the ability to refurbish rather than replace mat means this is very sustainable as well as eye catching.

Designed for indoor use in shops, public buildings, schools, offices, hotels, leisure centres, train stations, bus stations and hospitals.

14mm closed construction

Internal Applications

Can incorporate logos and designs - please ask for technical assistance.

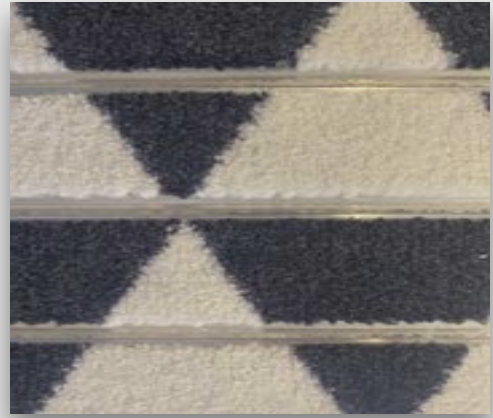

Please click here to see technical  
information on GRIME Design



Closed Construction Only





HD221



HD216



HD211



HD206



HD201



HD222



HD217



HD212



HD207



HD202



HD223



HD218



HD213



HD208



HD203



HD224



HD219



HD214



HD209



HD204



HD225



HD220



HD215



HD210



HD205



HD226



HD231



HD236



HD241



HD246



HD227



HD232



HD237



HD242



HD247



HD228



HD233



HD238



HD243



HD248



HD229



HD234



HD239



HD244



HD249



HD230



HD235



HD240



HD245



HD250



HD251



HD256



HD261



HD266



HD271



HD252



HD257



HD262



HD267



HD272



HD253



HD258



HD263



HD270



HD273



HD254



HD259



HD264



HD268



HD274



HD255



HD260



HD265



HD269



HD275



HD276



HD281



HD286



HD291



HD296



HD277



HD282



HD287



HD292



HD297



HD278



HD283



HD288



HD293



HD298





HD279



HD284



HD289



HD294



HD299



HD280



HD285



HD290



HD295



HD300

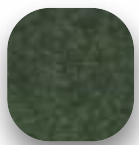

HD301



HD306



HD311



HD316

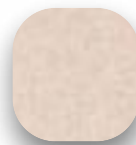

HD321



HD302



HD307



HD312



HD317



HD322



HD303



HD308



HD313



HD318



HD323



HD304



HD309



HD314



HD319



HD324



HD305



HD310



HD315



HD320



HD325



HD326



HD331



HD336



HD341



HD346



HD327



HD332



HD337



HD3412



HD347



HD328



HD333



HD338



HD343



HD348



HD329



HD334



HD314



HD344



HD349



HD330



HD335



HD340



HD345



HD350



Example Designs - showing how intricate designs/  
logos can be





**Accessories  
(Frames & Ramps)**



# Aluminium Matwell Frames

The Jaymart matwell frames are tailor made to your exact requirements. Frames are supplied in kit form with mitred corners, corner brackets and pre - drilled holes for screw fixing or with lugs for screed fixing. We will be pleased to quote for specially shaped frames e.g. circular, semi-circular, irregular dimensioned etc.

## Example Of Matwell Construction

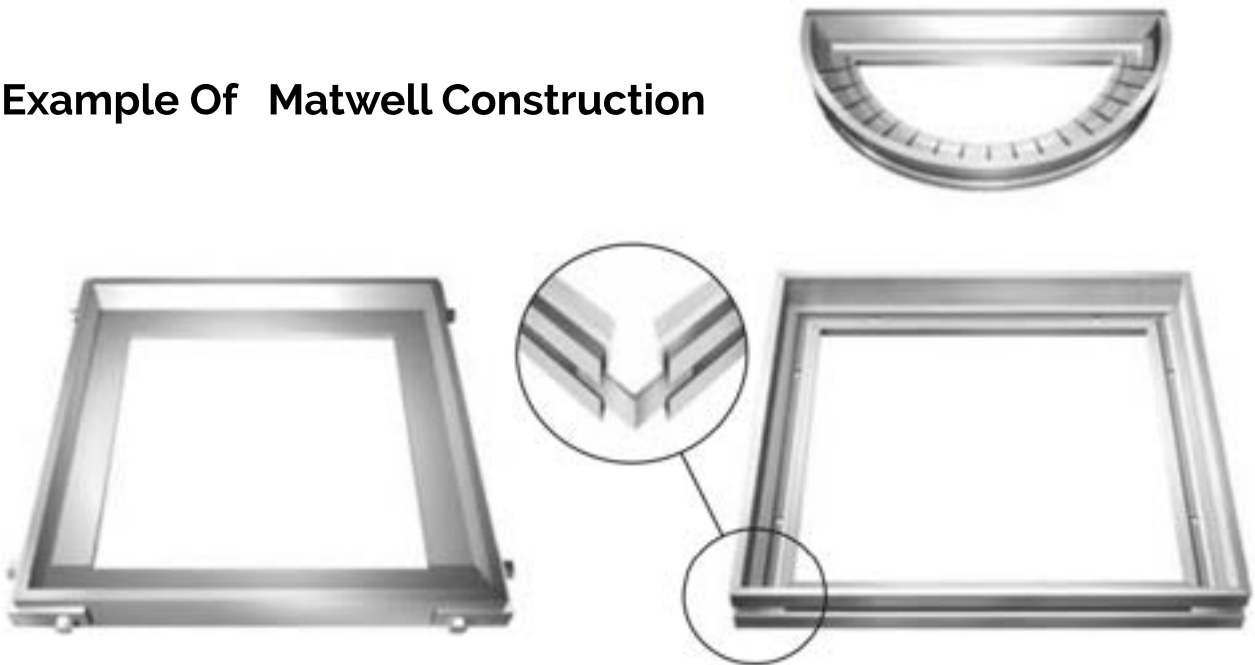

### Brass and Anodised Matwell Frames

for that extra prestigious look to the entrance foyer a brass or anodised matwell frame is the ideal answer



50mm x 50mm x 6mm Angle  
25mm x 25mm x 3mm Angle

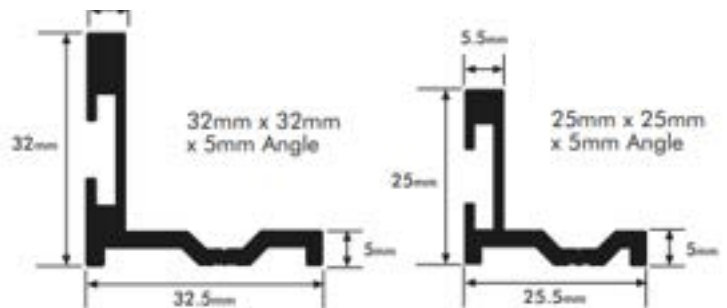

# Aluminium Ramp Frames for surface mounting

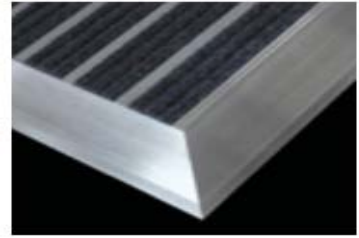

## Bevalu Aluminium Ramping

Bevalu is a surface mounted aluminium matwell frame with anti-trip bevelled edging for those situations where sunken recesses are impossible or impractical. Bevalu is supplied either in lengths or in mitred or drilled format for floor fixing with countersunk screws. Fixing is through the flange which is hidden when the mat is in place.

Bevalu is suitable for a wide range of entrance mats eg. PVC backed coir, Bigfoot, Street Range, Picador etc.

### Profile Size

20mm deep x 65mm wide (plus flange)

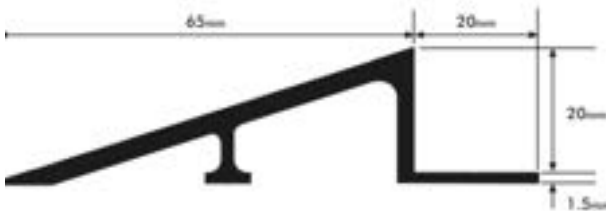

## Alu-Ramp Aluminium Ramping

Alu-Ramp is similar to Bevalu, but made specially for mats of lesser gauge eg Grime Range, Matkandu, Ingenius etc

Again this can be supplied either in lengths or in mitred and drilled formats for screw fixing.

### Profile Size

11mm deep x 60mm wide plus flange

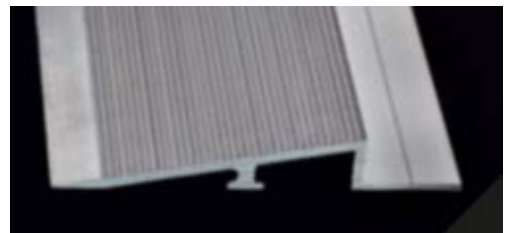

## Safe- T - Edge

Similar in Design to Bevalu and Alu- Ramp but to suit our low profile Street Range of mats together with 17mm PVC backed Coir and Alligator Aluminium mat systems.

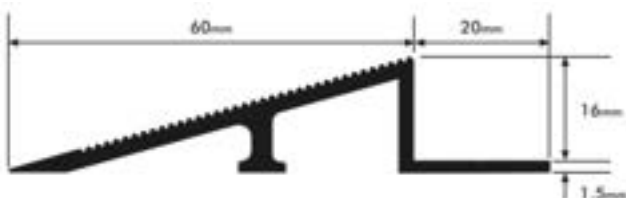

# Current Regulations, Installation & Cleaning/ Maintenance





**When specifying Entrance Matting there are several pieces of legislation that should be considered, as outlined briefly below. None of them dictate the exact type of matting to be used or the dimensions of the perfect matting system, simply because every building is different, and each requires an individual solution.**

**BS 7953:1999 Entrance Floor Systems. Selection, Installation and Maintenance** This standard outlines the key attributes of using Entrance Matting and the physical qualities a matting system needs to comply.

- Reduce the ingress of soiling and moisture into a building or to reduce the transfer of soil from one part of a building to another.
- Reduce slipping incidents by reducing the amount of soil and moisture tracked onto hard and resilient floors.
- Prolong the life of interior floor finishes by reducing the ingress of abrasive soil.
- Reduce the cleaning requirements of internal floors by reducing the ingress of soil onto internal floor finishes. To fulfil these functions an entrance flooring system should have the following qualities:
- Removal and retention of soil.
- Ease of cleaning and maintenance.
- Retention of physical characteristics.

All of Jaymart's Range of Entrance matting systems fully comply with BS7953:1999.

### **BS 8300-2:2018 Design of an accessible and inclusive built environment**

Together with BS 8300-1:2018 (External), this standard supersedes the original 2009+A1 2010 code, and explains 'how buildings, their approaches and immediate surroundings can be designed, build and managed to achieve an inclusive environment'.

The elements particularly relevant to the design and specification of Entrance Matting systems are as follows:

- Accessible Entrances: 'Type of threshold needed to allow safe and stepfree access; the ease of operation of the entrance door; the minimum effective clear width through the doorway; the provisions for effective drainage whilst retaining level access.'
- Entrance Flooring Systems: 'At entrances to commercial buildings and buildings used by the general public, a suitable entrance flooring system to remove water and debris from the soles of shoes and wheelchair wheels should be provided, taking account of the volume of pedestrian flow and the distance required to accommodate the circumference of a large wheelchair wheel (a minimum of 2000mm)'. Refer to BS 7953 for specific guidance.
- Floor Surfaces:
- The ingress of soil and surface moisture to buildings, or their transfer between adjacent internal areas, should be reduced to the lowest practicable level, e.g. through the use of appropriate entrance flooring systems conforming to BS 7953.'
- Any matting should either have its surface level with the adjacent floor finish or, if surface laid, be of a type that has a rubber backing and chamfered edges. If, in exceptional circumstances, other types of surface laid mats are used, they should be securely fixed to the floor at their edges and at any joints to avoid the risk of tripping or slipping.'
- Deep pile carpets and coir matting on the surface of the floor or within a mat well should not be used.'

### **WELL Standard**

The WELL Standard is made up of 10 Concepts, each covering features with distinct health intents, including advice on how to create a healthy entrance (AIR08):

- All regularly used entrances to the building that have pedestrian traffic to the exterior use an entryway system composed of grilles, grates, slots or rollout mats that are at least the width of the entrance and 3 m [10 ft] long in the primary direction of travel (sum of indoor and outdoor length).

Information taken from the above sources has been interpreted and summarised by Jaymart Rubber & Plastics Ltd to aid specifiers; however, we can take no responsibility for incorrect interpretation.

For specific project guidance please contact us.

### **How we contribute towards your BREEAM points, LEED credits and WELL certification**

With a commitment to reduce our environmental impact, our ranges include options of 100% Econyl regenerated nylon and natural fibres from goats hair (a very sustainable source) contributing to green building practices. ECONYL® carpet fibres are eligible for LEED® points, so you can specify high performance entrance matting without compromising the environment. All the fibres used in Jaymart matting systems are produced in modern factories reducing waste and energy/ resources and the impact on the environment.

Our Aluminium rails are made from 100% recycled aluminium, which can be recycled to infinity without any loss of quality. Further more all the inserts are replaceable reducing the need for total replacement of the entrance matting system

The aluminium extrusion process uses a closed loop cooling system that reduces energy and waste by recycling water to further minimise our environmental impact.

**For specific project guidance please contact us.**

# Cleaning & Maintenance

## Cleaning and Maintenance

Jaymart entrance mats are designed to prevent the foot borne ingress of dirt and moisture into a building.

The aluminum ribs of the mat scrape dirt from shoe soles, whilst the heavy duty polypropylene brush inserts actively draw off dirt and moisture. The inserts are quick drying thus making a more effective entrance matting system.

## Daily Cleaning

Regular maintenance is vital to ensure that the Jaymart Aluminium mat systems remains effective.

Normal daily soiling can be dealt with using a suction vacuum cleaner. A 2000-Watt model will give better results than a lower powered model. The use of rubber bladed wet floor tool attachment should increase the effectiveness of the cleaning.

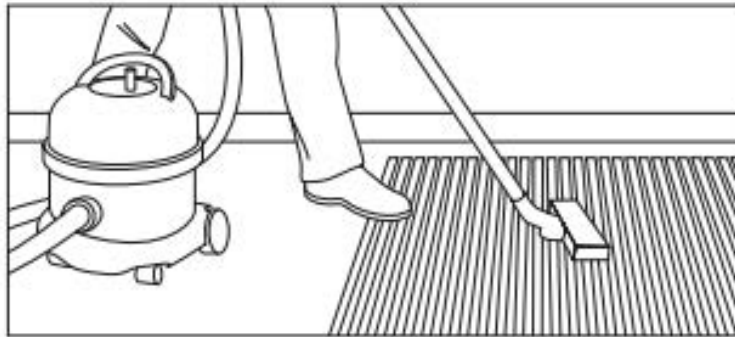

## Periodic maintenance

Best results can be achieved by the periodic use of a spray extraction carpet cleaning machine.

The use of a mild detergent (neutral pH) cleaning solution in the carpet cleaning machine should loosen ingrained soiling and aid the removal of oils and grease. More stubborn stains should be treated a solvent-based spot remover prior to re-cleaning with the detergent solution.

Chewing Gum can be removed by freeze spraying or with a proprietary chewing gum remover and then scraped or combed out of the matting carpet pile. This should be done before the full cleaning process is started.

Jaymart mats have replaceable heavy duty inserts

Depending on the regularity of maintenance and the volume of foot traffic, the strips may require replacement at infrequent intervals.

Replacement heavy duty Inserts may be obtained from Jaymart Rubber & Plastics Ltd.

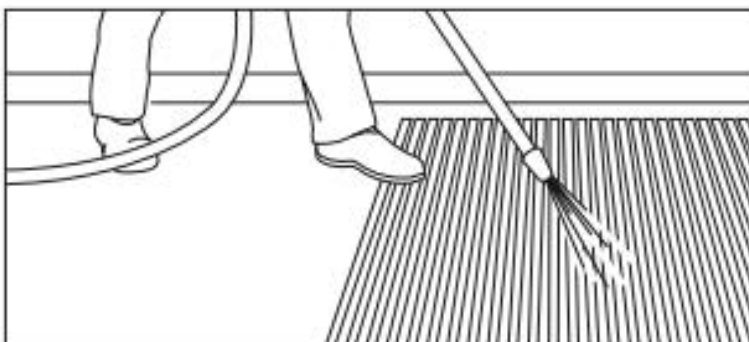

## Fitting Instructions - Recessed Matwell Frame & Entrance Matting

1. The matwell should be dug out to the depth of the frame allowing sufficient space for the matwell frame corner brackets.
2. The matwell frame should be assembled using the external corner bracket (plus nuts and bolts supplied where necessary)
3. The precise position of the matwell frame should be placed in position and the location of the fixing holes marked on the subfloor. using a chalk string line. 90 degree angles should be marked and checked using a set square,
4. The matwell frame should be placed in position and the location of the fixing holes marked on the subfloor.
5. The frame should be moved aside and the subfloor drilled and plugged where it has been marked.
6. The frame should be put back in position taking care to ensure that no distortion occurs. It may be necessary to pack underneath the frame in places where the matwell depth exceeds that of the frame.
7. Screwing the frame to the subfloor should commence in the centre of one side, working towards the corners. At all times care must be taken to ensure that the upright part of the angle section remains vertical, that the frame does not become bowed either horizontally or vertically and that the right angled corners remain at 90 degrees. It may be necessary to brace the frame with temporary battens to reduce the risk of bowing, The number of screws will vary depending on the size and nature of the installation.
8. Once the frame is fully screwed down, build-up and leveling screed be applied to the base of the matwell to reduce its depth to suit the entrance matting. The accuracy of this finish should be checked with a straight edge. No departure greater than 3mm from the bottom of a 3m straight edge is acceptable.
9. The screed should be allowed to fully cure and harden.
10. The entrance mat should then be laid loose in the finished matwell in accordance with the panel layout drawings provided with each matting system.
11. Any gaps between the outer edge of the outer edge of the matwell frame and surrounding subfloor and finish should be grouted.

**Recessed matwell sample**



LEVEL SCREED

Aluminium/brass matwell frame

Matting Type	Recommended Frame Section (Y)	Finished Recess Depth (X) (Dependent on gauge of your choice of insert material.)	Surface Mounted Ramping
Street Range Low Profile	32 x 32 x 5mm	16-20mm	Safe-T-Edge
Street Range Standard	32 x 32 x 5mm	20-22mm	Bevalu II
Buffer Zone Range	32 x 32 x 5mm	16-20mm	Safe-T-Edge
Alligator Range	32 x 32 x 5mm	14-20mm	Safe-T-Edge
Grime Range	25 x 25 x 5mm	11-17mm	Alu-Ramp
Grime Rail Firefighter	38 x 38 x 6mm (special section)	14-15mm	Safe-T-Edge

**Ramped sample**



SOLID BASE

Aluminium ramp

Aluminium ramp



## Template Production Guide

Hardboard or plywood templates are often required to manufacture non-rectangular, aluminium based entrance matting systems. It is the responsibility of the purchaser to provide these templates. Jaymart aluminium based entrance matting systems are manufactured to extremely close tolerances and it is therefore essential that templates are produced to the same degree of accuracy in relation to the size and shape requirements of the site. The following guidelines are provided to assist the purchasers template maker in producing accurate templates with which we can work.

1. Mat templates should be produced following the installation of the matwell frame.
2. Templates must be dimensionally stable. Hardboard and plywood are ideal. Vinyl and paper are not acceptable as they can bend, crease, stretch or shrink out of shape
3. Templates may be provided in one or more sections. Where more than one section is provided, abutment marks should be made to ensure proper alignment of the template sections. Templates should be marked "TOP", as appropriate.
4. The position of all doors relative to the mat should be marked on the template
5. The direction of traffic flow should be marked on the template. Bear in mind that foot traffic flow may occasionally change direction after stepping onto a mat. This may require special design features.
6. Templates should be a precise fit within an installed matwell frame. We will slightly reduce the mat size in relation to the template in order to facilitate fitting and removal. Templates made to "actual mat size" are perfectly acceptable but should be marked accordingly. We will then reproduce exactly the size and shape of the template. We do not recommend that previously fitted mats should be used to produce templates.
7. Mat panels will be made to similar size, as appropriate to the overall size and shape of mat required. In the event of particular panel size requirements, we must be informed accordingly. Attention should be paid to such considerations as ease of fitting beneath fixed door leaves, avoiding joints in major traffic paths, aligning mat panel joints in surrounding tile areas etc.
8. Where two mats are installed in close proximity, a datum line running through both templates should be marked and identified accordingly. This line will establish the precise relationship between the mats and enable us to ensure that the ribs align.
9. Templates should be kept dry during making and transportation to our manufacturing facilities.
10. It is the customers responsibility to deliver templates to our premises.
11. Jaymart retain ownership of the template following manufacture of the mat.

Please remember, the template you provide is our only information regarding your requirements. Any External factor which may have a bearing on the mat layout should be indicated on the template.

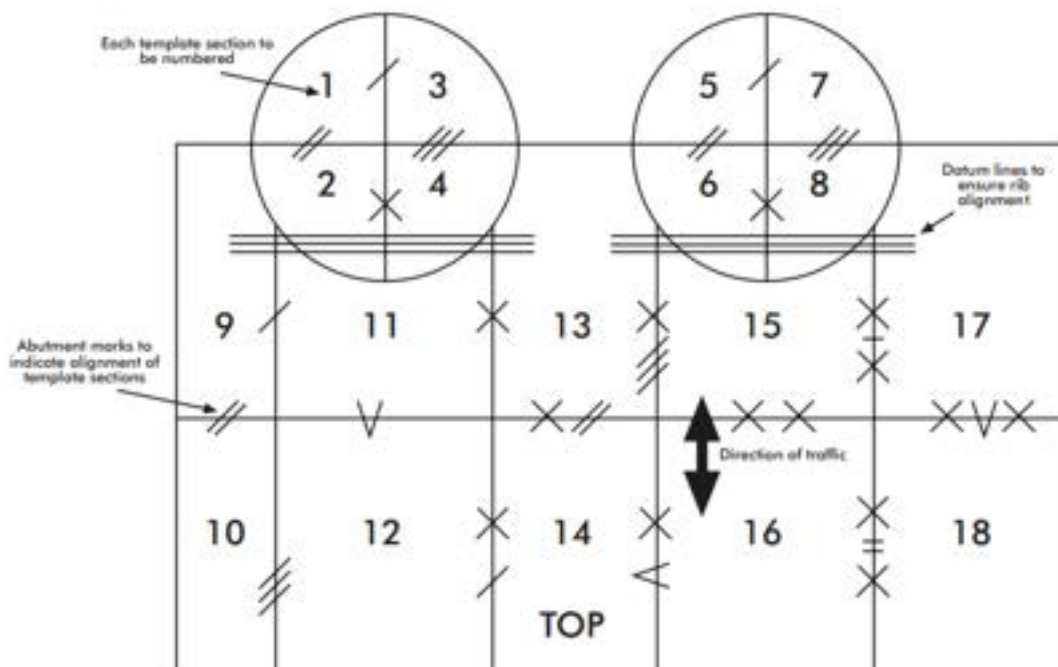

We are happy to recommend and work with experienced matting installation contractors who would be able to shape on site or produce accurate templates on request. Please contact our customer service team for further details.

# All mats look the same from the top.....

Jaymarts range of matting systems compared with others on the market are significantly thicker gauge and heavier - meaning you can be assured of years of use and can replace the inserts rather than the whole matting section which with thinner sections is unlikely. Refurbishment rather than replacement - more environmentally friendly and sustainable.

## Jaymart Alligator



## Competitors Equivilent





*Jaymart*

**Jaymart Rubber &  
Plastics Limited**

**Roman Way, Crusader  
Park,**

**Warminster**

**BA12 8SP**

**Tel 01985 218994**

**Email:  
sales@jaymart.co.uk**

**www.jaymart.co.uk**