

DELTA®

DELTA® protects property. Saves energy. Creates comfort.

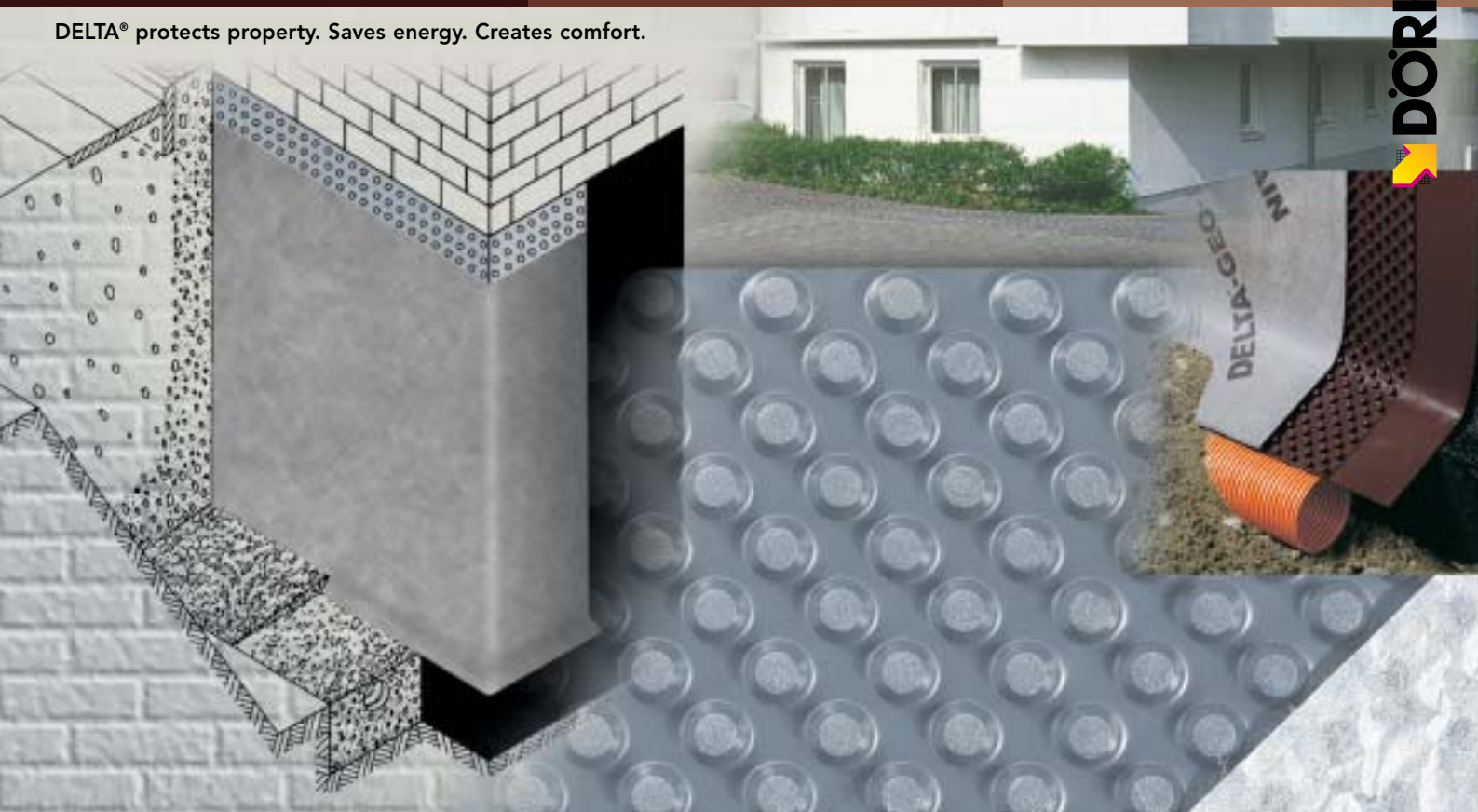

DÖRKEN

Technical Planning

DELTA® systems for foundation-wall protection,
drainage, and waterproofing.

Dörken – Leading by technical competence. For more than 100 years.

Two comprehensive programmes. Based on innovative ideas and state of the art production lines: High-quality products made by Dörken GmbH & Co. KG for roof applications as well as for foundation-wall protection, drainage, and waterproofing, set standards for reliability, durability, and energy saving. Located in the Westphalian town of Herdecke, it is the company's goal to provide to its customers day to day with customised solutions and products of outstanding quality. Having met these ambitious standards for more than 100 years, Dörken is and will always be a highly respected partner for planners, architects, distributors and installers.

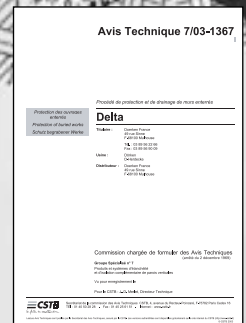
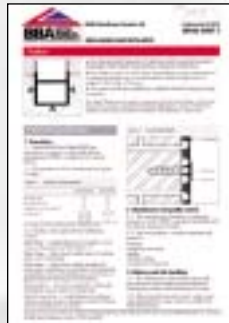

Table of Contents.

■ Efficient Protection from Damp and Water for Buildings, Cellars, Underground Parking Lots, and Tunnels	4
■ Important Codes Regulating Waterproofing and Drainage	5
■ The DELTA® Range of Products	6
■ Protection and Drainage Systems for Compression-resistant Vertical Waterproofing	8
■ Protection and Drainage System for Compression-sensitive Vertical Waterproofing	10
■ Protection System for Compression-resistant Vertical Waterproofing	11
■ Protection and Drainage Systems for Compression-resistant and Compression-sensitive Horizontal Waterproofing	12
■ Alternative Sub-base Course for Floor Slabs Free from Static Loading	14
■ Surface Gas Drainage Systems	15
■ Vertical and Horizontal Waterproofing	16
■ Damp Proof Course (DPC) at the building's basement	18
■ DPC for Wooden Beam Constructions and as L-shaped Barrier	19
■ System for Rehabilitating Damp Walls from the Inside	20
■ DELTA® – A Complete Range of Products for Cellars	21
■ Excavation Sheet piling and Lining Systems for Civil-engineering Applications	22
■ Civil-engineering Construction in Areas Exposed to Underground Water	24
■ Systems for Underground Tunnel Construction	26
■ Systems for Open Tunnel Construction	28
■ System for Tunnel Rehabilitation	29
■ Technical Data Table	30
■ List of Accessories for Foundation-wall Protection, Drainage, and Waterproofing	34
■ Performance Characteristics of DELTA® Dimpled Sheets	36
■ What DELTA® System Fits which Application?	38

Efficient Protection from Damp and Water for Buildings, Cellars, Underground Parking Lots, and Tunnels.

Water – A “Pressing” Problem

According to scientific studies, damage to subgrade building structures ranks third in the damage statistics of buildings. To a large extent, the – sometimes extensive – damages caused by moisture penetration in cellars, for instance, occurs due to previously wrong assessment of underground water pressure, resulting in the selection of unsuitable protection measures.

Having reached the ground in the form of precipitation, water finds its own way. If it infiltrates the soil swiftly and without delay, a building will not be exposed to water pressure. If precipitating water seeps away only slowly, however, water pressure will continue to act on a building as long as precipitation continues. An equivalent situation occurs whenever

underground water infiltrates permeable subsoil layers until it reaches a building. The two last-described situations occur fairly frequently.

Things get tough whenever the soil is impermeable, so that any rainwater is effectively prevented from seeping away. In this case, building walls will be permanently exposed to water pressure.

The planning of waterproofing, drainage, and protection systems depends largely on which of these three situations of water exposure is present. A careful investigation of the structure of the soil as well as all other relevant factors, such as the characteristics of the landscape is therefore absolutely vital and important.

Choosing the correct waterproofing system depends on hydrostatic pressure

conditions, always remembering that less complex waterproofing systems are less failure-prone and, therefore, considerably safer. Efficient drainage can be a great help in many of these cases. It highly simplifies the construction of the waterproofing layer by relieving the load caused by dammed-up seepage water.

Finally, no waterproofing system can exist without effective protection from mechanical impacts. Even the best protection layer cannot fulfill its duty if, for instance, it is injured by sharp-edged rocks during backfilling.

Damp control in buildings is a complex problem which, however, is easy to be solved for planners and installers who decide to go for a system solution which provides for all relevant requirements and details. A system solution called DELTA®.

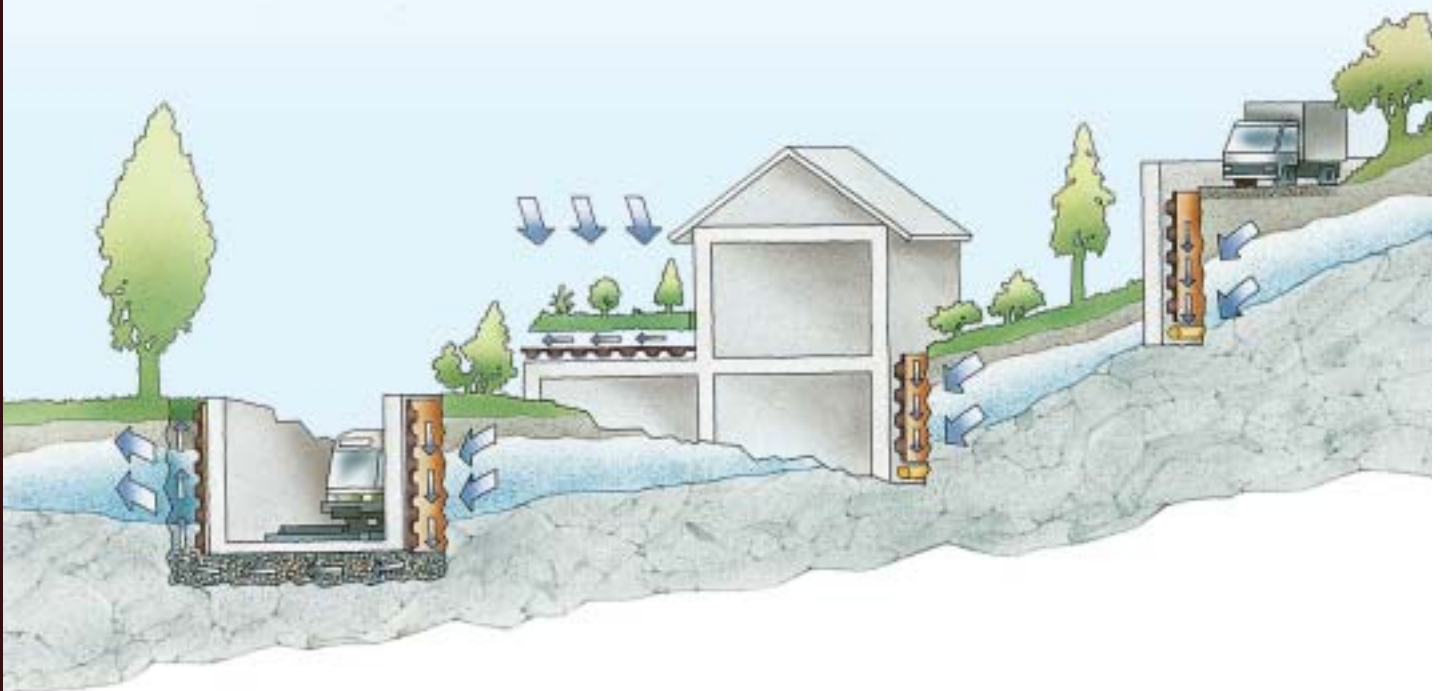

Important Codes Regulating Waterproofing and Drainage.

Basic European Standards

■ EN 13252, EU-wide.

EN 13252 is a standard of great importance for protection and drainage systems: It specifies the mandatory properties of geotextiles and geotextile-related products that are essentially used in drainage systems to perform the functions of filtering, separating, and draining. These properties include tensile strength, dynamic perforation resistance, characteristic opening size, water permeability, water-flow capacity in the plane, and material durability.

EN 13252 does not describe minimum requirements; instead, it specifies the methods to be used in verifying these properties in regulations that apply uniformly in all EU member countries. Its quality seal is considered a mark of outstanding quality even in many coun-

tries that do not belong to the EU.

EN 13252 specifies that no recycled material shall be used whenever polypropylene and polyethylene are used as raw materials. DELTA® geotextiles and DELTA® drainage sheets comply with these demands, which is why they have been awarded a CE sign (0799-CPD-13).

■ DIN 18195, Germany.

This standard regulates damp-control methods for buildings, the materials that can be used, and their protection.

■ DIN 4095, Germany.

This standard regulates the design and dimensioning of drainage systems.

■ Avis Technique, France.

This certificate is based on DTU 20.1, determining the properties and applications of building products.

■ BBA, Great Britain.

It certifies the products application, properties, and processability.

■ BS. 8102: 1990

This is the code of practice for "Protection of structures against water from the ground". This standard provides guidance on methods of dealing with, and preventing the entry of water from surrounding ground, into a building below ground level. The main methods described are the use of applied waterproofing finishes, watertight construction and drained cavity construction.

Products made by Dörken have all been tested under these standards. In addition, they comply with the requirements of numerous other European test standards.

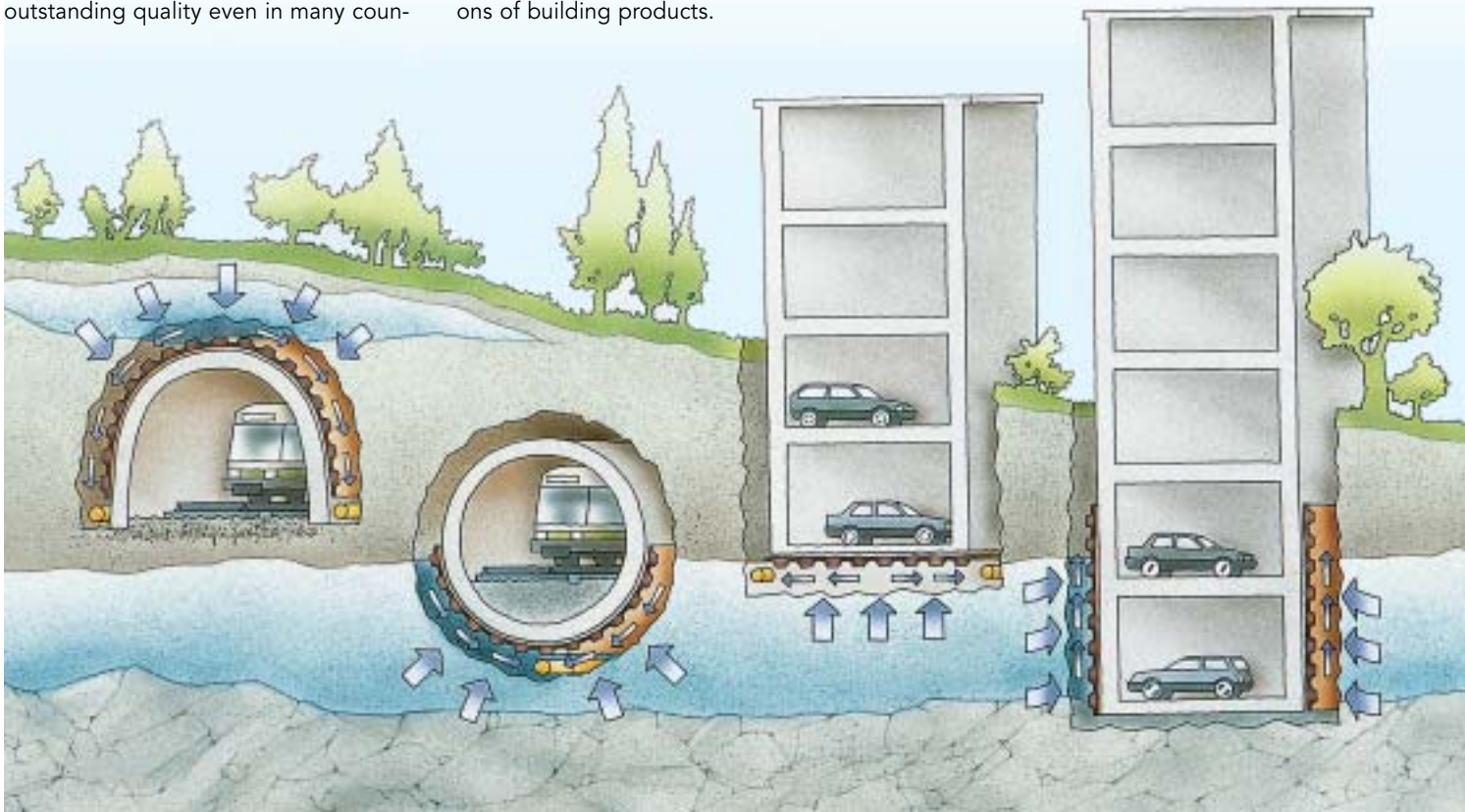

The DELTA®-Range of Products.



DELTA® products for foundation-wall protection, drainage, and waterproofing are best suited for a wide range of building and rehabilitation applications. Including a variety of dimpled sheets and dampproof courses, the DELTA®-THENE waterproofing system, and accessories for any and every application, DELTA®-products offer a tailor-made solution for every problem. Our method of combining precisely-matched products into complete DELTA® systems provides added value easily to be reached.

Made of a special type of polyethylene, DELTA® dimpled sheets form highly efficient seepage and drainage layers. They are compression-resistant, maintaining their outstanding hydraulic properties even under heavy and permanent loads. The fused-on geotextile layer of the multi-layered DELTA® dimpled sheets filters soil particles out of the seepage water, thus preventing the air gap from becoming clogged up. With a welded-on

plaster mesh, dimpled sheets may be used as backing for shotcrete and mortar.

DELTA® dimpled sheets are rot-proof, resisting saline solutions, inorganic acids, alkalines, and polar liquids. They are proof against attack or modification by any of the minerals, humic acids, and bacterial catabolic products that naturally occur in the soil, as well as by bacteria, fungi, and micro-organisms. The response



DELTA®-MAUERWERKSSPERRE

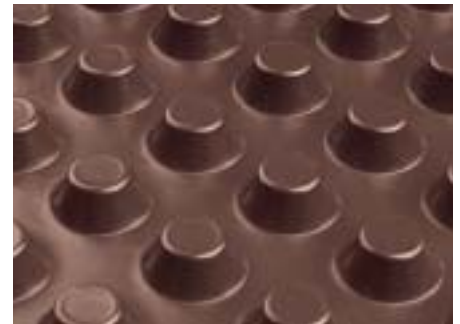

DELTA®-MS



DELTA®-PROTEKT



DELTA®-MS 20



DELTA®-THENE



DELTA®-PT

of all sheet types to soil or underground water is completely neutral, nor will they leach any harmful and/or ecologically doubtful substances. Care should be taken to ensure that they are not permanently exposed to UV radiation.

DELTA®dampproof courses can be laid quickly, providing reliable insulation against rising damp: Even high pressure will not lower their resistance.

DELTA®-THENE, a waterproofing system for horizontal and vertical applications, consists of a cross-laminated special HDPE sheet and a waterproofing and adhesive layer made of bitumen rubber. This waterproofing system may be used in a wide variety of applications.



Like all our drainage products, DELTA®-NP DRAIN, DELTA®-DRAIN, DELTA®-TERRAXX, DELTA®-GEO-DRAIN Quattro, and DELTA®-GEO-DRAIN 800 TP conform to the requirements of the CE sign and/or those of the EN 13252 standard (Certificate No. 0799-CPD-13).



DELTA®-NP DRAIN



DELTA®-GEO-DRAIN TP 800



DELTA®-DRAIN



DELTA®-GEO-DRAIN Quattro



DELTA®-TERRAXX

Protection and Drainage Systems for Concrete

DELTA®-TERRAXX/DELTA®-DRAIN/DELTA®-NP DRAIN.

The Situation:

Compression-resistant structures or waterproof coatings that transmit forces such as, for instance, rigid or flexible sealing slurries, perimeter insulation boards, water-proof concrete, or cold-setting self-adhesive waterproofing sheets such as DELTA®-THENE always require reliable protection and drainage systems to retain their functions permanently.

DELTA®-TERRAXX: Ideal Dimensions for Cost-efficient Laying.

Universally applicable, DELTA®-TERRAXX provides a maximum of safety for cellar walls from hydrostatic water pressure, seepage, and artesian water. The dimples facing the soil form a drainage layer that extends over the entire surface, exceeding in its performance the requirements of DIN 4095. The fused-on geotextile layer keeps the dimple structure from being clogged up. Offering outstanding drainage performance at 3.1 l/s · m when

exposed to a load of 20 kN/m² (plus a certain safety reserve), DELTA®-TERRAXX can be simply wrapped around the walls of most cellars thanks to its width of 2.40 m, making the sheet very easy to lay. When applied to perimeter insulation boards, DELTA®-TERRAXX provides the necessary insulation from contact with the surrounding soil thanks to its plane reverse face. Its high compressive strength of about 400 kN/m² permits installation at depths of up to 10 m. In addition, its silver surface gives DELTA®-TERRAXX low emissivity as well as enhancing its heat transition resistance.

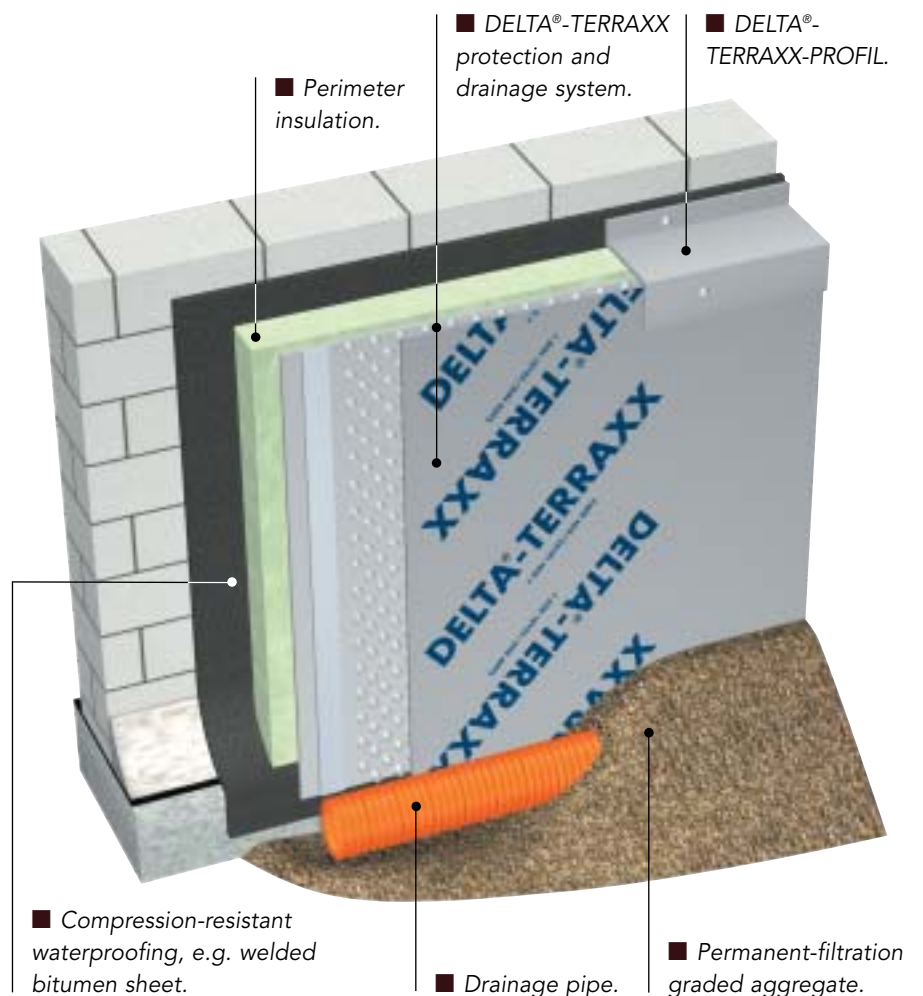

Compression-resistant Vertical Waterproofing.

DELTA®-DRAIN measurable: An Air Gap of measurable benefit.

In addition to providing outstanding drainage and protection, DELTA®-DRAIN creates an air gap on the side facing the foundation wall which serves to conduct water and may, whenever required in special circumstances, form a vapour-pressure levelling layer. The flow capacity of DELTA®-DRAIN amounts to 1.5 l/s · m under a load of 20 kN/m². The material may be installed at depths of up to 5 m.

DELTA®-NP DRAIN: Cost-efficient and Highly Reliable.

With its special filtration cloth, this dimpled sheet features an outstanding compressive strength of about 150 kN/m², acting as a reliable drainage system in civil engineering, supporting walls of all types, open tunnels, and underground parking lots. Filtering out fine-grained soil particles, the filtration cloth ensures that the water flow down towards the drainage pipe remains intact. DELTA®-NP

DRAIN ensures a notable hydrostatic water pressure relieve on waterproofing systems. Its special structure with its relatively closely-spaced dimples enhances its drainage capacity. Its flat edges enable a relatively cheap and easy installation. DELTA®-NP DRAIN complies with the requirements of EN ISO 9001.

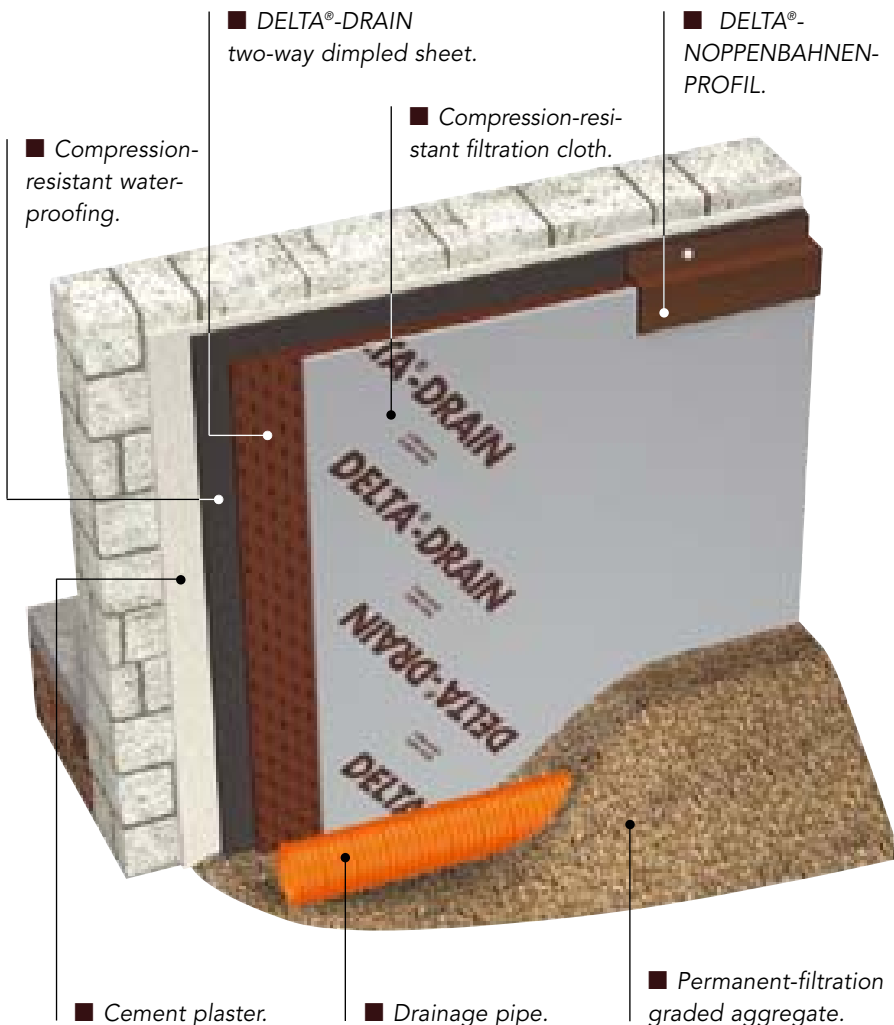

Common dimpled sheets get clogged up with soil and lose their drainage function.



Drainage sheets with a welded-on geotextile form a seepage layer which ensures that any water influx drains away safely.

Protection and Drainage System for Compression-sensitive Vertical Waterproofing.

DELTA®-GEO-DRAIN Quattro.

The Situation:

Subgrade vertical surfaces will be exposed to hydrostatic pressure whenever seepage water is prevented from draining away immediately. By avoiding pressure build-up, a drainage system conforming to DIN 4095 permits the installation of low-priced waterproofing and eliminates the need for expensive tanking structures.

The drainage system consists of two levels. A vertical drainage sheet gathers the water that comes in from the surrounding soil and guides it downward, where it is carried away in a drain pipe installed at foundation level. The upper edge of the drainage system may prove vulnerable if the moulding cap that protects it is not installed properly. In that case, water may collect between the waterproofing and the drainage surface. Water running down the facade constitutes a similar risk if the upper sealing strip has not been expertly applied.

While synthetically-modified bitumen coatings bridge cracks and form permanently elastic waterproofing systems, they are always compression-sensitive. In such cases, point and line loads must be avoided.

DELTA®-GEO-DRAIN Quattro: Reliable Water Drainage.

Because of its special dimple design, this 4-ply sheet is highly compression-resistant, so that any structural waterproofing coats are dependably protected from damage. With its disproportionately large drainage capacity it may be used in situations where great volumes of water need to be handled. The micro-perforation of the slip film allows any water penetrating between it, and the dimpled sheet proper, to drain away through a fused-on nonwoven cloth. Any water will drain away safely through this additional layer, even if the moulding

cap has not been properly fixed in place. This permanently prevents water from gathering between the bitumen coating and the slip film. In addition, the slip film ensures that soil movements are not transmitted to the waterproofing.

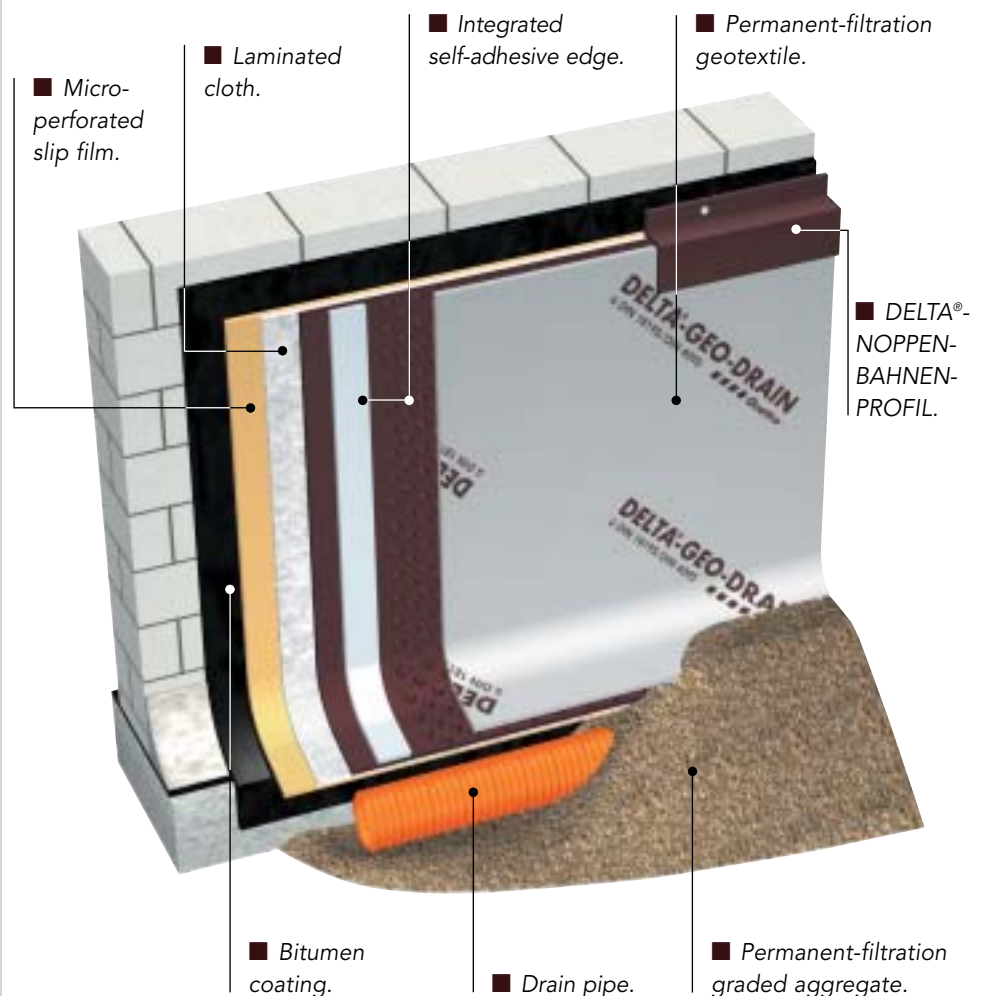
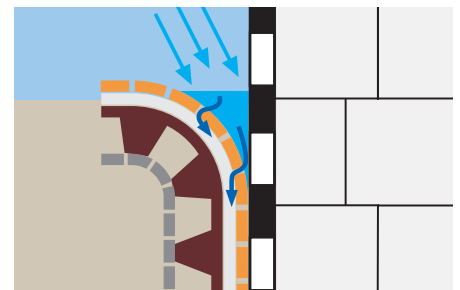

Protection System for Compression-resistant Vertical Waterproofing.

DELTA®-MS.

The Situation:

To ensure that compression-resistant surfaces and waterproofing systems which transmit forces (e.g. perimeter insulation boards) remain intact for a long time, they must be reliably protected from moisture and damage.

DELTA®-MS: Optimum Safety Right from the Start.

The protection of DELTA®-MS is highly effective on the foundation wall. This dimpled sheet made from special high-density PE safely insulates foundation walls from the moisture of the soil. It achieves complete protection of any compression-resistant waterproofing and/or perimeter insulation. More than 1,800 dimples per square metre ensure that pressure is evenly distributed and point loads, including those on perimeter insulation boards, are kept to a minimum. At about 250 kN/m², the compressive strength of the sheet is outstanding.

It is safe for drinking water, will not rot in soil, and gives additional heat insulation. The necessary drainage capacity may be provided either by a permeable soil or by a heaped-up seepage layer with a minimum thickness of 50 cm consisting of some mineral material, such as gravelly sand (grain size B32). If required, DELTA®-MS may also be used as a vapour-pressure levelling layer. Its flat overlapping edges ensure precisely-fitting waterproof seams, while the diagonal layout of its dimples enables the sheet to be bent along a straight line and fitted precisely around edges.

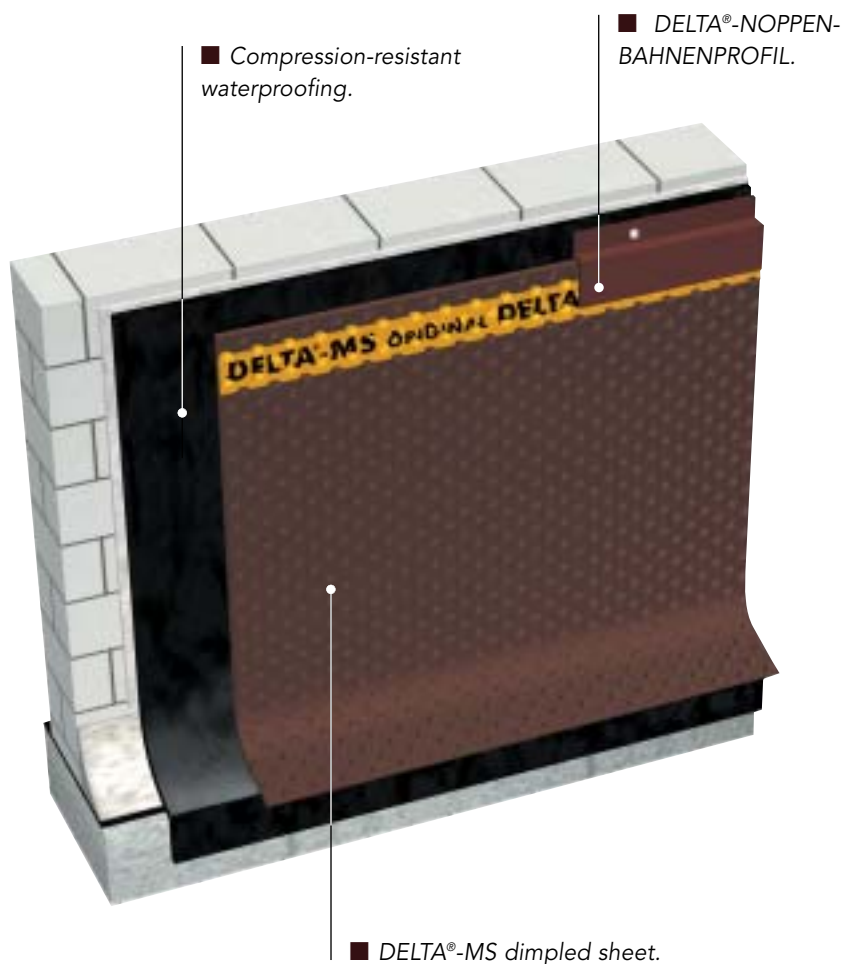

Protection and Drainage Systems for Cost-sensitive Horizontal Waterproofing.

DELTA®-TERRAXX/DELTA®-NP DRAIN.

The Situation:

Horizontal ceilings covered with granular material need to be waterproofed for their protection. At the same time, soil moisture must be drained away safely.

Protection from seepage water is needed for horizontal surfaces such as, for instance, the covered roofs of underground parking lots, terraces, and flat garden roofs, as well as underneath the surface course of parking decks.

DELTA®-TERRAXX: Extreme Water Flow Is No Problem.

When applied to pressure-resistant structures or waterproof coatings that transmit forces such as, for instance, rigid or flexible sealing slurries or cold-setting self-adhesive waterproofing sheets such as DELTA®-THENE, DELTA®-TERRAXX offers a maximum of safety. The 2-ply material reliably protects the masonry and provides drainage for the entire surface.

Permanent soil pressure is distributed, and any moisture penetrating the upward-facing filtration cloth is drained away between the dimples. At about 400 kN/m², the outstanding compressive strength of the dimples ensures unimpeded drainage. When installed under a layer of soil, the permanent-filtration geotextile prevents the air gap from being clogged up by sludge. Because of their large drainage capacity, DELTA®-TERRAXX high-performance sheets may be used even in appli-

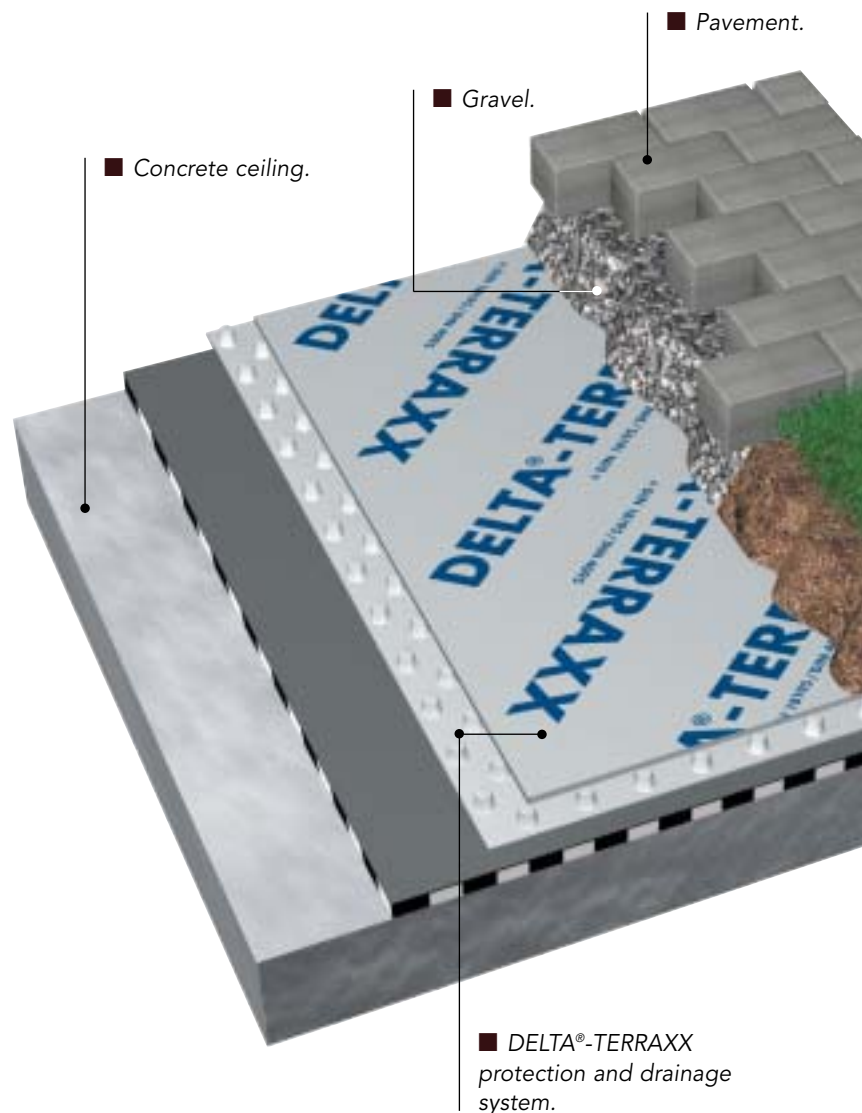

ompression-resistant and Compression-

cations where the flow of water is extreme. Their self-adhesive overlapping edges as well as their ideal width of 2.40 m make them economical to lay. Installed as a second waterproof shell in front of the waterproofing layer, DELTA®-TERRAXX represents a universal solution conforming to DIN 18195. The material is ideal for protecting the covered ceilings of underground parking lots, terraces, and flat garden roofs from seepage water, as well as for installation under the surface of parking decks.

DELTA®-NP DRAIN: Safety from Waterlogging and Root Penetration.

DELTA®-NP DRAIN is simply laid straight from the roll on top of a building structure or waterproofing layer. It may be easily cut to length with a knife. To facilitate overlap sealing, each sheet features an undimpled edge strip that is about 10 cm wide. DELTA®-NP DRAIN reliably and permanently protects green underground-garage roofs and parking decks from

moisture penetration. Equipped with a special filtration cloth, this dimpled sheet reliably prevents waterlogging and root penetration. Installed in earth-covered ceilings, it will bear the weight of a wheelbarrow without problems. When covered by a layer of soil or gravel of 20 cm or more, it will support a wheeled loader. Thanks to its special structure and its relatively closely-spaced dimples, its drainage rate ranges around 2.25 l/s · m. DELTA®-NP DRAIN conforms to EN ISO 9001.

Gradient	DELTA®-NP DRAIN	DELTA®-TERRAXX
2 %	0.20 l/s · m	0.32 l/s · m
3 %	0.26 l/s · m	0.42 l/s · m

Drainage capacity.

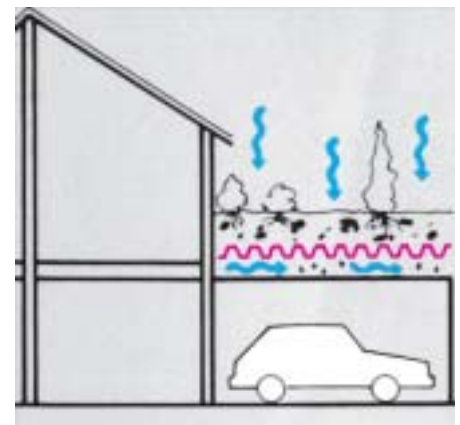
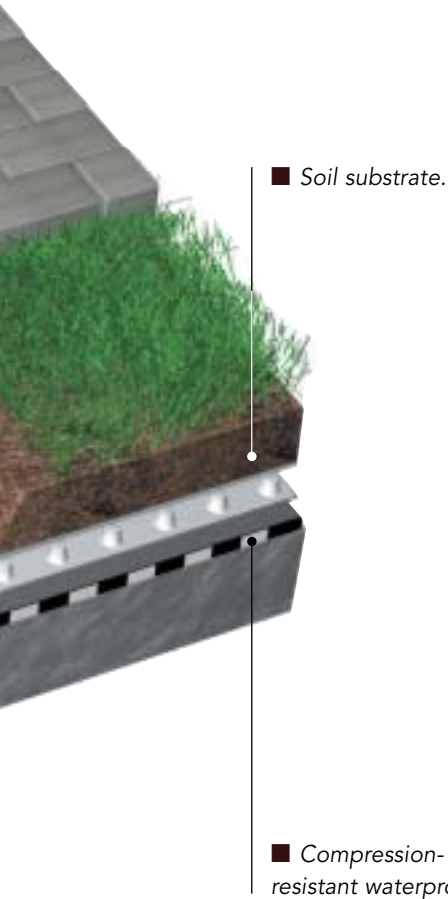

Installed under roof terraces and parking lots, DELTA®-TERRAXX and DELTA®-NP DRAIN make sure that any precipitation is drained away safely.

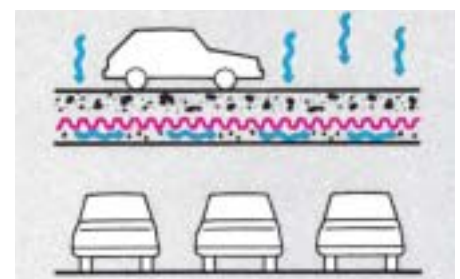

Alternative Sub-base Course for Floor Slabs Free from Static Loading.

DELTA®-MS Sub-base Course

The Situation:

Reinforced floor slabs must be placed on a foundation that will support the spacers bearing the welded wire mesh. Lean concrete as a sub-base course demands an extra excavation depth of 5 cm. In addition, the cost of installation is high, extra equipment is needed, and there is a waiting period. All in all, this means that, particularly where relatively large surfaces are concerned, construction is expensive, and progress is slow.

DELTA®-MS Sub-base Course: Less Cost and a faster job.

When using DELTA®-MS as a sub-base course, you apply crucial advantages straight from the roll: high compressive strength, minimum installation time, no equipment cost, no additional excavation, no waiting period, additional protection of the floor slab from rising damp, and grout loss is effectively prevented from leaching downward. DELTA®-MS resists acids, alkalines, oils, and solvents. Its toughness and stiffness enables the

dimpled sheet to bear the weight of people and wheelbarrows, and it will safely carry the strip-shaped reinforcement mesh spacers.

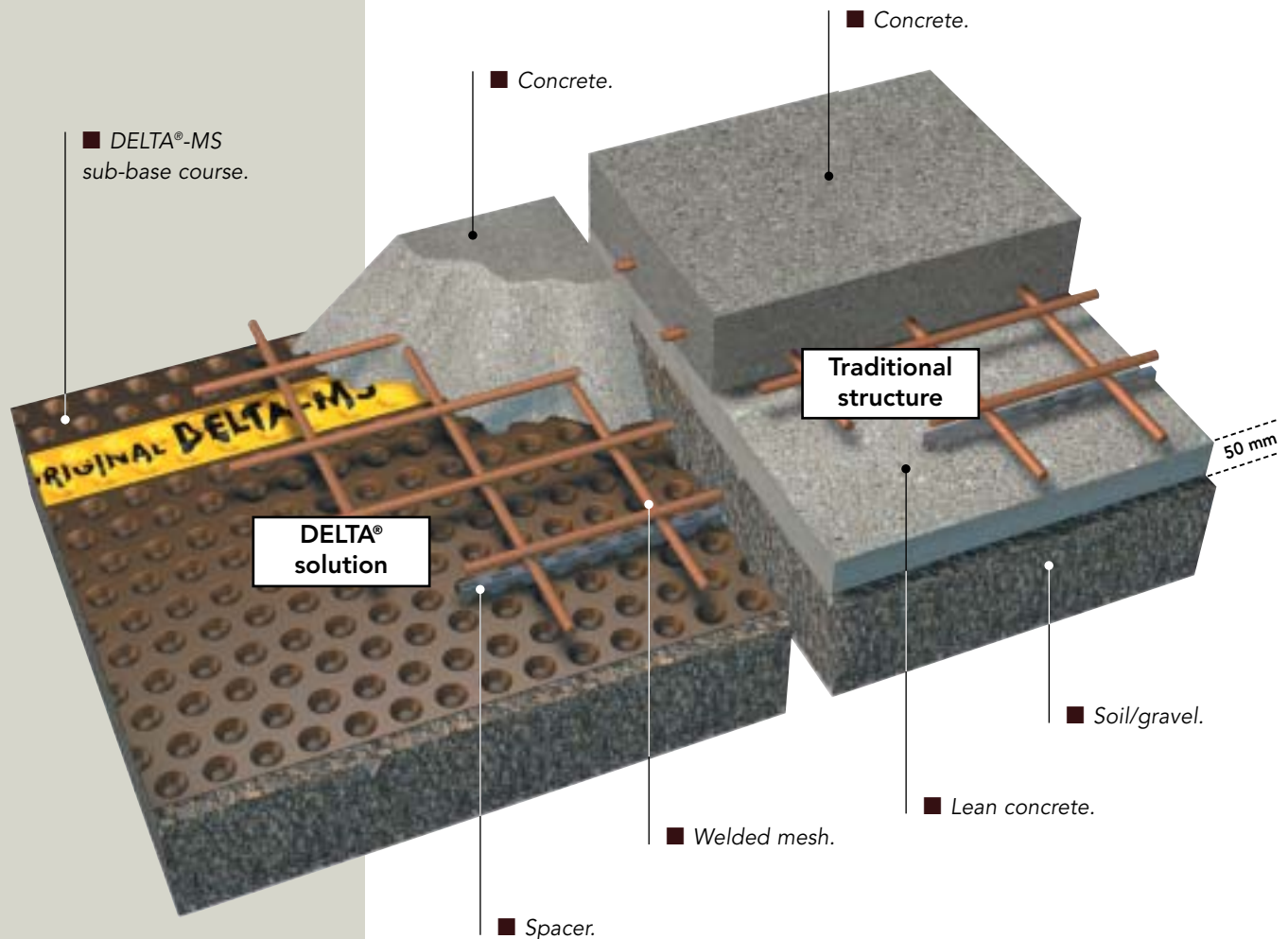
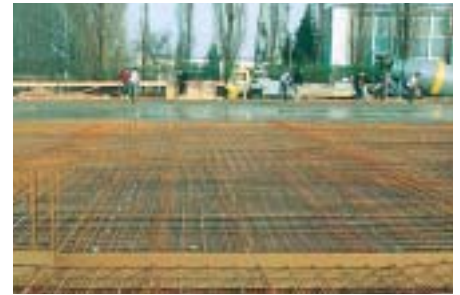

Surface Gas Drainage Systems.

DELTA®-GEO-DRAIN Quattro/DELTA®-TERRAXX.

The Situation:

Radon is a radioactive inert gas that is produced naturally by the decay of Uranium 238. Being an inert gas, it is extremely mobile. Emerging from rocks containing uranium, it penetrates unnoticed into cellars and flats, exposing the inhabitants to long-term pollution. After smoking, radon ranks second among the causes of lung cancer! Standards recommended by the EU Commission suggest that more than 100,000 houses in Germany require rehabilitation.

Methane is a non-poisonous, colourless, and odourless gas which is produced by the decomposition of wood and other organic matter when lignite is formed. Methane occurs in the vicinity of coal seams and former refuse dumps, which includes all hard-coal mining areas that are to be found in quite a number of European countries. Former moorland settled after drainage is similarly affected. Air containing 4.4 to 16 volume percent of methane may form an explosive mixture and may even become flammable if the proportion of methane increases further.

DELTA®-GEO-DRAIN Quattro/ DELTA®-TERRAXX: Great Performance at a Fair Price.

To make sure that radon and methane cannot be present in a building in concentrations high enough to constitute a safety or health hazard, the two gases must be able to escape without obstruction. Gas drainage normally involves installing a gas-carrying layer of filtration gravel underneath the floor slab, with the layer being carried on upwards along the cellar walls to the ground level. This continuous layer of gravel enables gases to escape unobstructed into the ambient air. However, this approach is very complicated and cost-intensive. Thanks to their

extreme drainage capacity of $3.1 \cdot 10^{-3} \text{ m}^2/\text{s}$, which multiplies by 7 where gas drainage is concerned, and a compressive strength of 400 kN/m^2 , both DELTA®-GEO-DRAIN Quattro and DELTA®-TERRAXX are ideal for vertical gas drainage when combined with a classical filtration gravel layer underneath the floor slab. It is important to remember in this context that the top apertures of the drainage sheet should be covered with a layer of gravel to enable the gas to escape into the ambient air without difficulty.

Using DELTA® drainage sheets permits combining gas and water drainage, as both rain and seepage water will be safely drained away from the building.

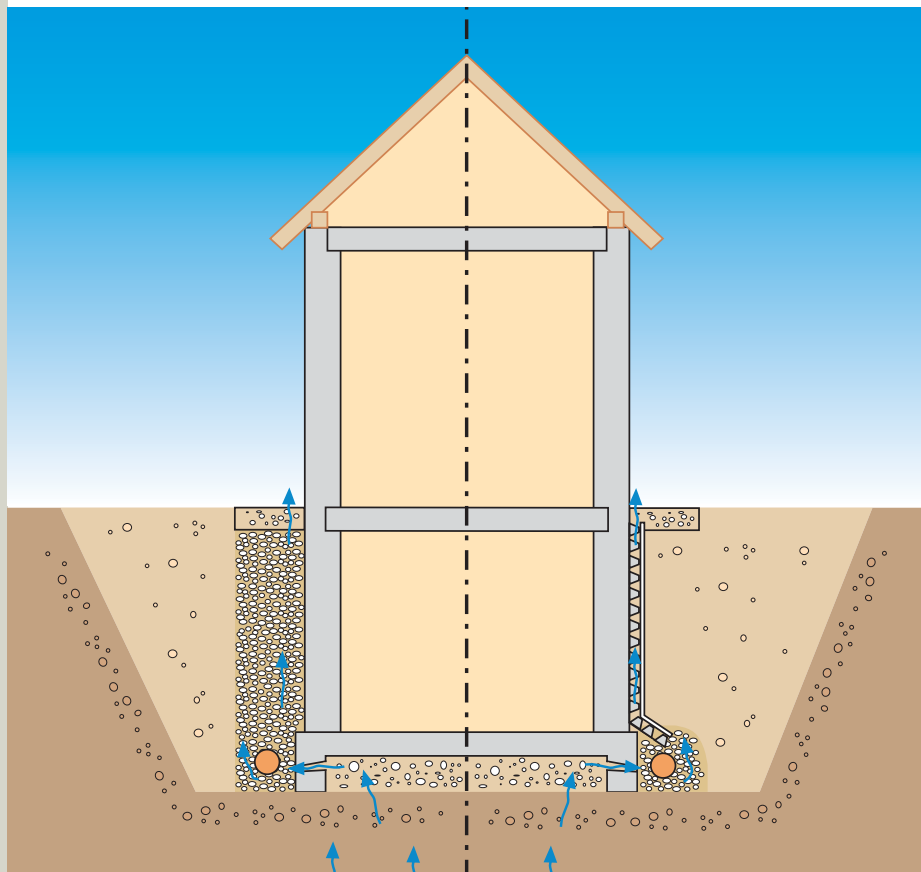

Traditional gas wall drainage compared to the approach involving DELTA®-GEO-DRAIN QUATTRO/DELTA®-TERRAXX.

Vertical and Horizontal Waterproofing.

DELTA®-THENE.

The Situation:

Soil moisture and unpressurised seepage water impacting walls and floor slabs are to be found in most cellars. Soil moisture means that the soil is highly water-permeable, so that it can be freely infiltrated. No draining is required, as the gravel or sand subsoil does not permit water to build up pressure. Even for relatively impermeable a waterproofing system can be achieved which, however, requires an intact drainage system. While there are many waterproofing systems that can be used in these conditions, they are often very complex and costly. Some materials require two steps of application, while a torch is required for others.

Horizontal concrete floor slabs also require protection from rising damp, which holds particularly true for residential houses without a cellar that are built directly on top of the floor slab.

Waterproofing is also indispensable in bathrooms, balconies, and similar standard housing elements which are not adequately protected by other suitable measures. Moisture protection is particularly important in bathrooms installed in environments that are sensitive to moisture. Thus, protection measures need to be particularly elaborate in wooden houses, wooden post and beam constructions, and prefabs.

DELTA®-THENE: The Universal Solution.

Cold-setting self-adhesive and DIN-conformable, DELTA®-THENE sheets provide reliable waterproofing for vertical and horizontal exterior and interior surfaces. Sheets consist of a combination of a 4-ply cross-laminated special HDPE sheet and a sealing and adhesive layer of bitumen rubber. Laid straight from the roll, the material safely bridges any cracks in walls or floors; besides, it is extremely flexible and is completely proof against driving rain immediately after it has been glued on.



DELTA®-THENE is an excellent vapour barrier.

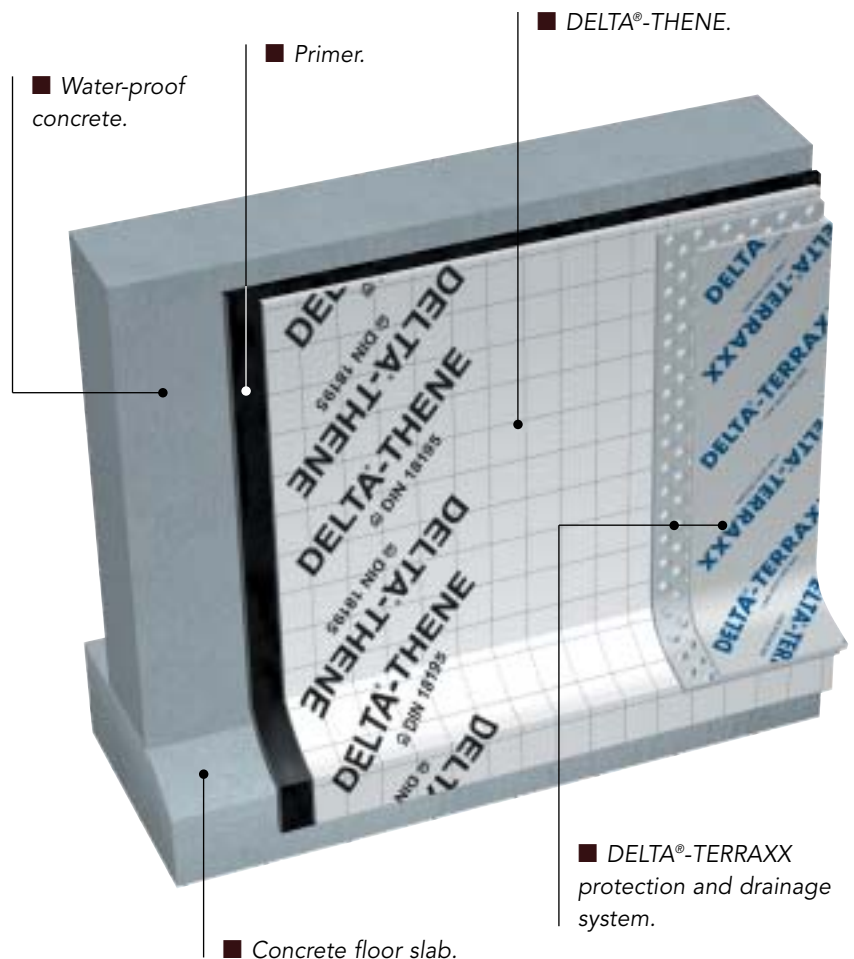

Swift, easy and clean installation is a particular advantage in waterproofing the outer walls of cellars that are in contact with the soil, for sheets can be simply 'wallpapered' into place. This being so, they may easily be laid up to 50% faster than conventional waterproofing systems. The printed-on grid makes it easier to cut sheets to size and lay them precisely. Sheets can be installed without trouble even in very tight excavations because no scaffolding is needed. With DELTA®-THENE, a uniform waterproofing layer having the standard thickness of 1.5 mm can be applied in a single pass. No curing or drying time is required, so that protection, drainage, and/or perimeter

insulation layers may be installed and the excavation filled up immediately after DELTA®-THENE has been applied. Combined with DELTA®-TERRAXX protection and drainage sheets, DELTA®-THENE forms a complete high-quality waterproofing, protection, and drainage system that can be installed with considerable savings in time.

In horizontal waterproofing applications, DELTA®-THENE can be applied at least 50 % faster than conventional welded bituminous sheets. No torch is required, and connections between the material and plastic windows or doors are unproblematic. Any damage caused in the

DELTA®-THENE layer by subsequent activities may be easily repaired by gluing on a patch.

Floor-heating coils or pipes laid out on a DELTA®-THENE surface may be held in place with strips cut from the self-adhesive sheet. Nor is it problematic to connect DELTA®-THENE to dampproof courses made of plastic, for the sheets will adhere very well to almost all types of plastic even without a primer. However, contact surfaces must always be clean, bitumen-resistant, and free from dust.

Practical DELTA® waterproofing and dampproofing accessories:



Large surfaces can be sealed easily and quickly with DELTA®-THENE.



**DELTA®-THENE PRIMER
DELTA®-THENE LOW-TEMPERATURE PRIMER**



DELTA®-THENE-TAPE T 300



DELTA®-TAPE

Damp Proof Course (DPC) at the building's basement.

DELTA®-MAUERWERKSSPERRE.

The Situation:

Dampproof courses are horizontal sealing layers inserted in the bed joints of foundation walls. Their purpose is to ensure that damp cannot penetrate the foundation wall from below.

The width of a dampproof course should be such that it cannot be bridged by moisture on either side of the masonry, which is why we recommend that dampproof courses should be at least 10 cm wider than the thickness of the wall.

To avoid moisture bridges in the vicinity of the hollow moulding that forms the transition between the external wall of the cellar and the floor slab, hollow mouldings should be as narrow as possible to ensure that the horizontal dampproof course is adequately connected to the vertical cellar-wall waterproofing system.

If the strip comes into contact with bituminous materials used for waterproofing the vertical cellar wall, the material of the strip must be bitumen-proof.

DELTA®-MAUERWERKSSPERRE: Bitumen-compatible with a Non-slip Surface structure.

0.4 mm thick, DELTA®-MAUERWERKSSPERRE bears the general test certificate of the building regulatory authority. Both faces feature a non-slip profile to ensure optimum mortar adhesion. Strips are bitumen-compatible, rot-proof, and UV-stabilised. They remain highly flexible even at low temperatures, so that no cracks will occur in the material. Being relatively thin, strips will come off the roll quickly and are easy to work with.



DPC for Wooden Post and Beam Constructions and as L-shaped barrier.

DELTA®-PROTEKT.

The Situation:

Wooden post and beam constructions may be damaged by rising damp. Inserting a horizontal sealing layer prevents damp from being conveyed from the floor slab to the post and beam construction. As the strip bears the whole weight of the sill directly above, it needs to be particularly robust. In the area of contact, the surface of the floor slab must be finished so that it is free from any unevenness that might damage the dampproof course.

In buildings with cavity walls, inner leaves and floors must be protected from moisture at the foot of the hollow space. For depending on the type of facing brick used and the quality of the mortar joints, moisture may penetrate the outer brick shell and enter the space between the leaves in the event of a heavy rainfall. For this reason, L-shaped dampproof strips are generally installed at the foot of brick facings. At the same time, these strips are also used for dampproofing window and door lintels and window sills, so that driving rain is safely kept away.

DELTA®-PROTEKT: Outstanding Stability and Tear Resistance.

DELTA®-PROTEKT is in conformity with DIN, particularly robust, and highly immune to shear forces. As the sheet is protected by cloth facings on both sides, the strip is ideal for use in wooden post and beam constructions.

Being bitumen-compatible, DELTA®-PROTEKT may be used in conjunction with any other type of waterproofing system. When it is used as an L-barrier, installation begins by marking the height of the strip with a chalk string. The mark should be no less than 15 cm above the base. Next, DELTA®-PROTEKT

is glued to the backing wall with DELTA®-THAN adhesive and held in place by additional mechanical fasteners. DELTA®-MWSP-CLIPs may be used as an alternative.

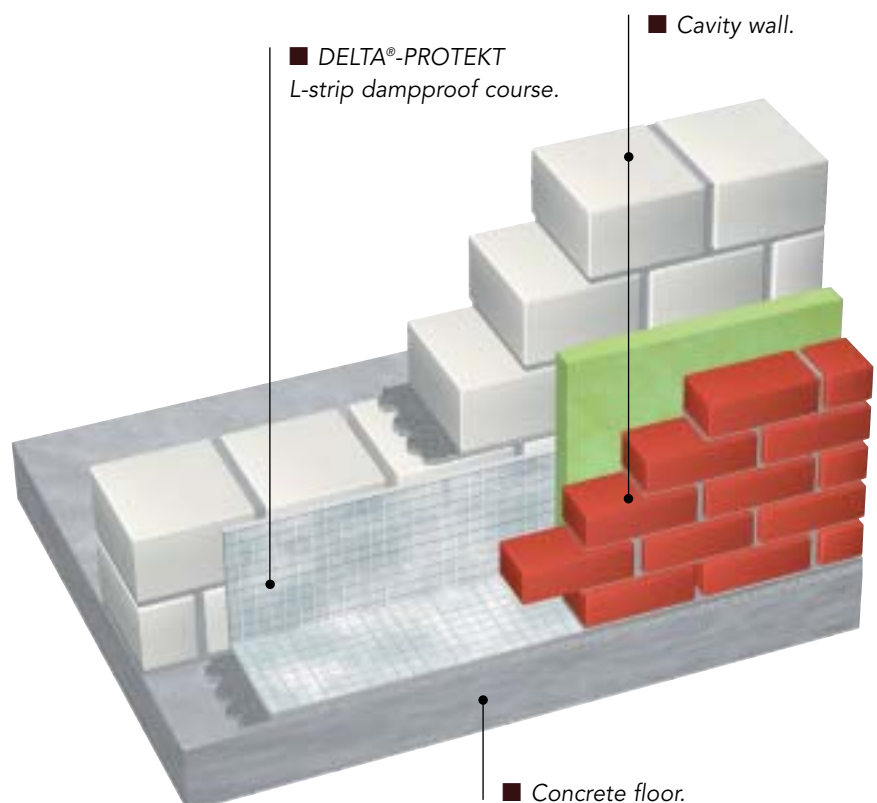
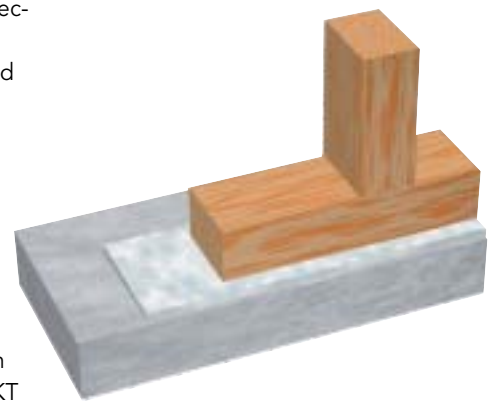

System for Rehabilitating Damp Walls from the Inside.

DELTA®-PT.

The Situation:

Damp walls in rooms and/or cellars are impossible to dry out in many cases, which is why it is often very difficult to turn damp cellars into habitable rooms.

DELTA®-PT: Safety for Dry Wall Surfaces.

The DELTA®-PT dimpled mesh reliably insulates walls from the inside, forming a waterproof, robust foundation for gypsum and lime cement mortar as well as for plasterboard, ensuring dry wall surfaces in any cellar for a long time.

With its 8mm dimples, DELTA®-PT creates an air gap between the damp cellar wall and the plaster, with ventilation slits integrated at the floor and the ceiling to allow moisture to escape.

Whenever the surface of a damp wall is densely covered with salt crystals, DELTA®-PT may be installed without ventilation slits to act as a vapour barrier which stops the absorption of moisture from the air in the room. This prevents moisture from being transported in large quantities to the space behind the sheet by the powerful hygroscopic action of the salt.

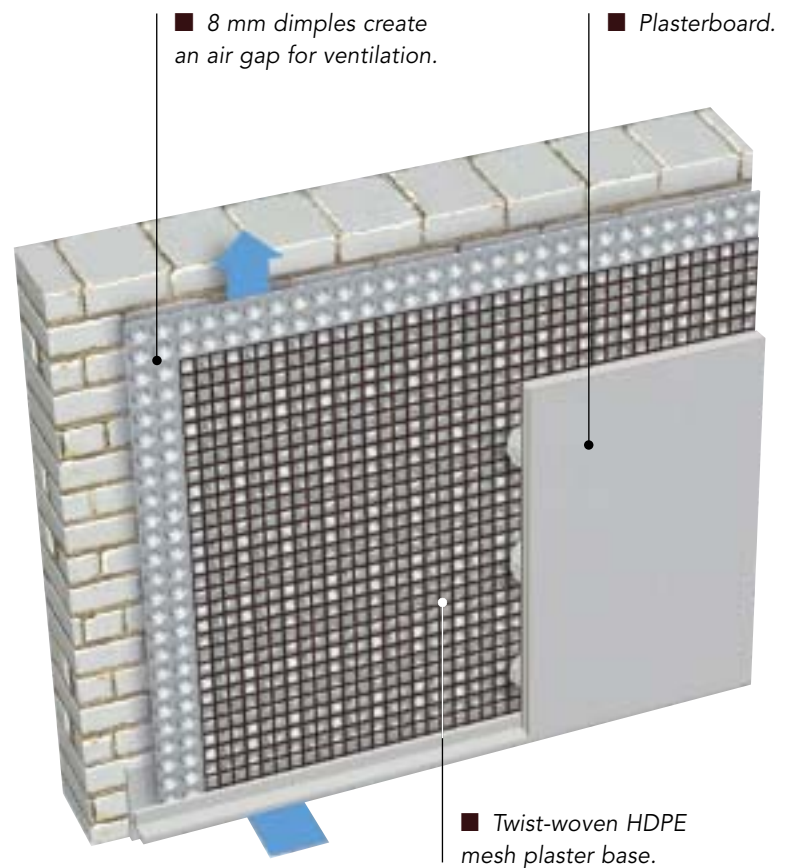

DELTA® – A Complete Range of Products for Cellars.

DELTA®:
Always a Cost-efficient and Safe Solution.

The comprehensive DELTA® range of products offers ideal solutions for foundation-wall protection and drainage as well as cellar waterproofing. Equally suitable for horizontal and vertical application, products are universally easy, simple, and cheap to install, saving you time and money and offering guaranteed maximum safety.

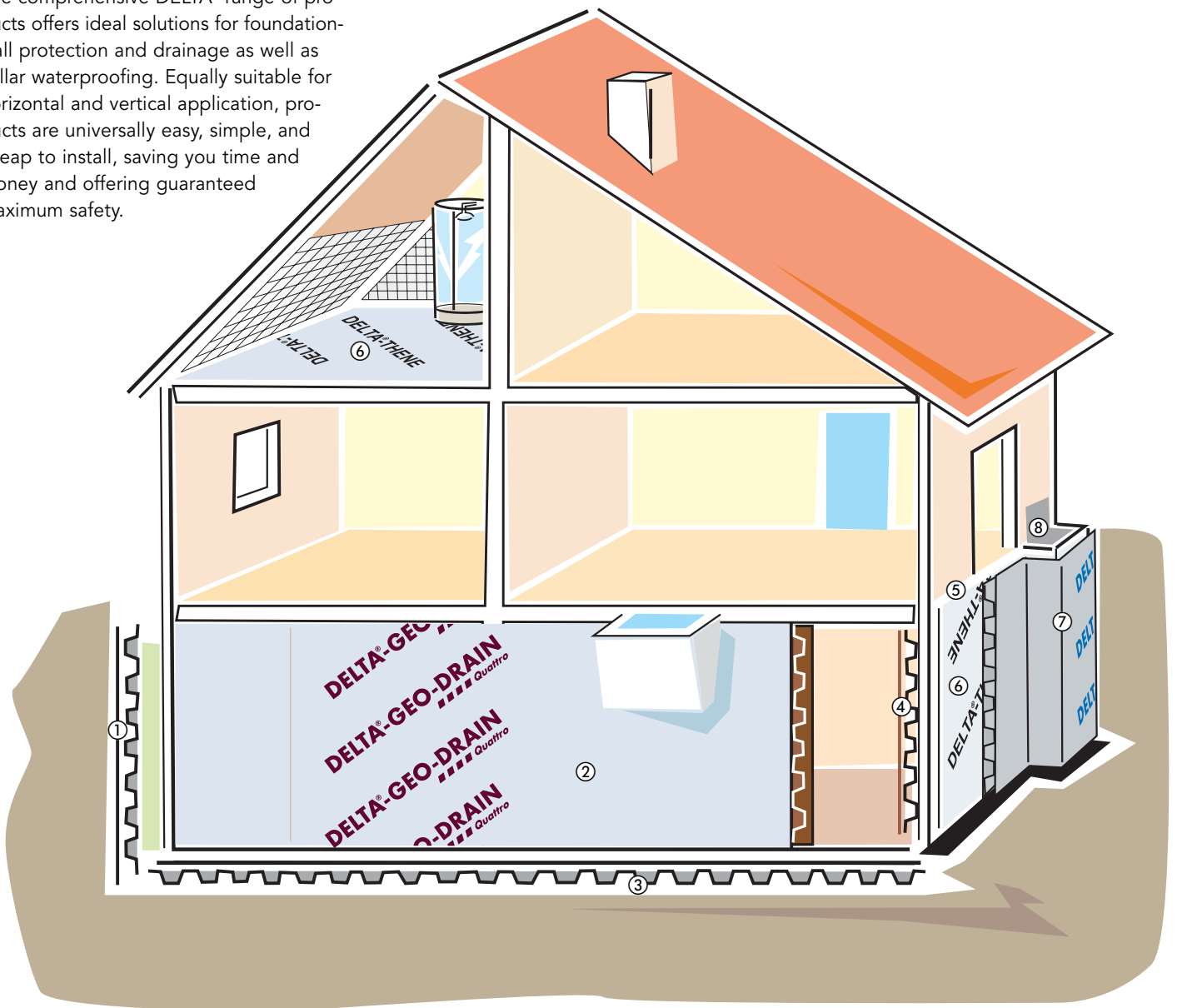

- ① DELTA®-TERRAXX with perimeter insulation board.
- ② DELTA®-GEO-DRAIN Quattro.
- ③ DELTA®-MS sub-base course.
- ④ DELTA®-PT.

- ⑤ DELTA®-MAUERWERKSSPERRE.
- ⑥ DELTA®-THENE waterproofing sheet.
- ⑦ DELTA®-TERRAXX.
- ⑧ DELTA®-PROTEKT L- barrier.

Excavation Sheeting and Lining System

DELTA®-NP DRAIN/DELTA®-TERRAXX/DELTA®-GEO-DRAIN 800 TP.

The Situation:

As a general rule, civil-engineering and underground constructions such as retaining walls, bridge abutments, tunnels, and earth-covered ceilings are exposed to high water flow and high pressure loading from the surrounding soil and concrete.

The DELTA® Solution.

In these applications, the functions of DELTA® dimpled sheets are comparable to those in foundation-wall protection and drainage: Dimples of various dimensions and configurations ensure that the flow of water from horizontal and vertical seepage layers is safely drained away. Filtration cloth prevents soil particles from being carried into the drainage layer. Facing the soil, the dimples form

a high-performance vertical drainage layer across the entire surface, conveying the water either to an outlet or to a horizontal drain pipe.



A typical way of installation is to attach the dimpled sheet with a gas or nail gun.

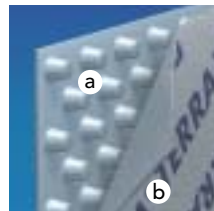
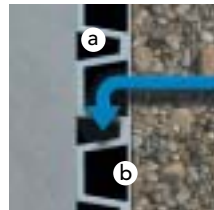

- ① Concrete retaining wall
- ② DELTA®-dimpled sheet comprising:
 - a - a dimpled sheet and
 - b - a fused-on filtration cloth
- ③ Filtration gravel
- ④ Drain pipe
- ⑤ Backfill

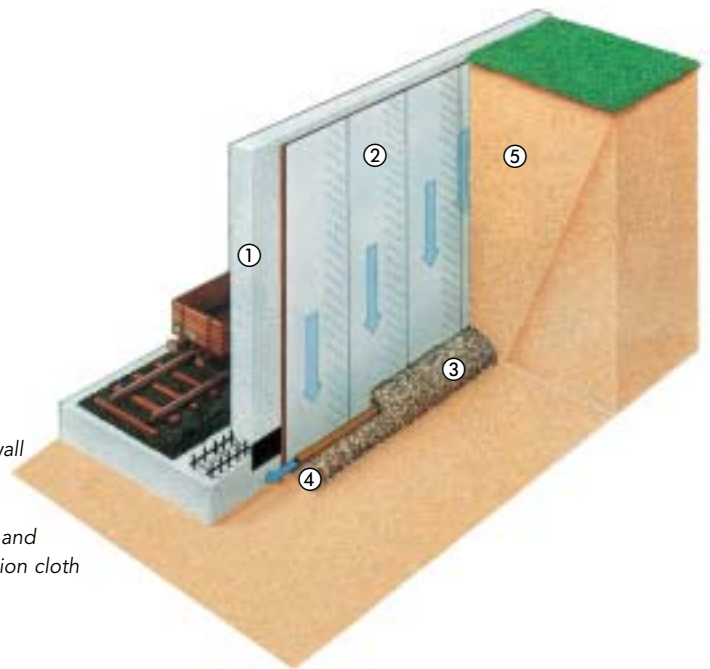

		DELTA®-NP DRAIN	DELTA®-TERRAXX	DELTA®-GEO-DRAIN 800 TP
Maximum installation depth		7 m	10 m	20 m
Drainage capacity i = 1 under constant load in l/s · m	0 kPa	2.25	3.50	3.50
	10 kPa	1.99	2.97	3.11
	20 kPa	1.94	2.72	3.06
	50 kPa	1.87	2.54	2.93
	90 kPa	–	2.00	2.79
	200 kPa	–	–	2.61

s for Civil-engineering Applications.

The Situation:

One of the most common methods of securing the sides of an excavation is timber walling. The process involves inserting planks, square or round timbers, precast reinforced-concrete slabs, or trench sheeting between the piles rammed into the floor of the excavation. Rolled-steel sections, shell-less reinforced-concrete piles, or unreinforced concrete piles with permanent shells may serve as vertical elements. Depending on the depth of the excavation, timber walls may have to be anchored in the soil. The most popular variant of timber walling is the classical 'Berlin' lining technique, which involves manually removing the soil between the piles along the edge of the excavation, pushing planks that have been cut to size behind the flanges of the piles, and hammering in wedges to press them firmly to the soil.

As timber walls made in this way feature a large number of seams, drainage layers must always be equipped with a filtration cloth to keep them from clogging up.

DELTA®-TERRAXX:

The Solution for "Berlin" Timber Walls.

DELTA®-TERRAXX is an ideal filtration and seepage layer for 'Berlin' timber walls. Sheets should be installed so that the filtration cloth faces the timber wall. Their self-adhesive overlap zones prevent cement sludge from entering and clogging up the seepage layer when concrete is poured.

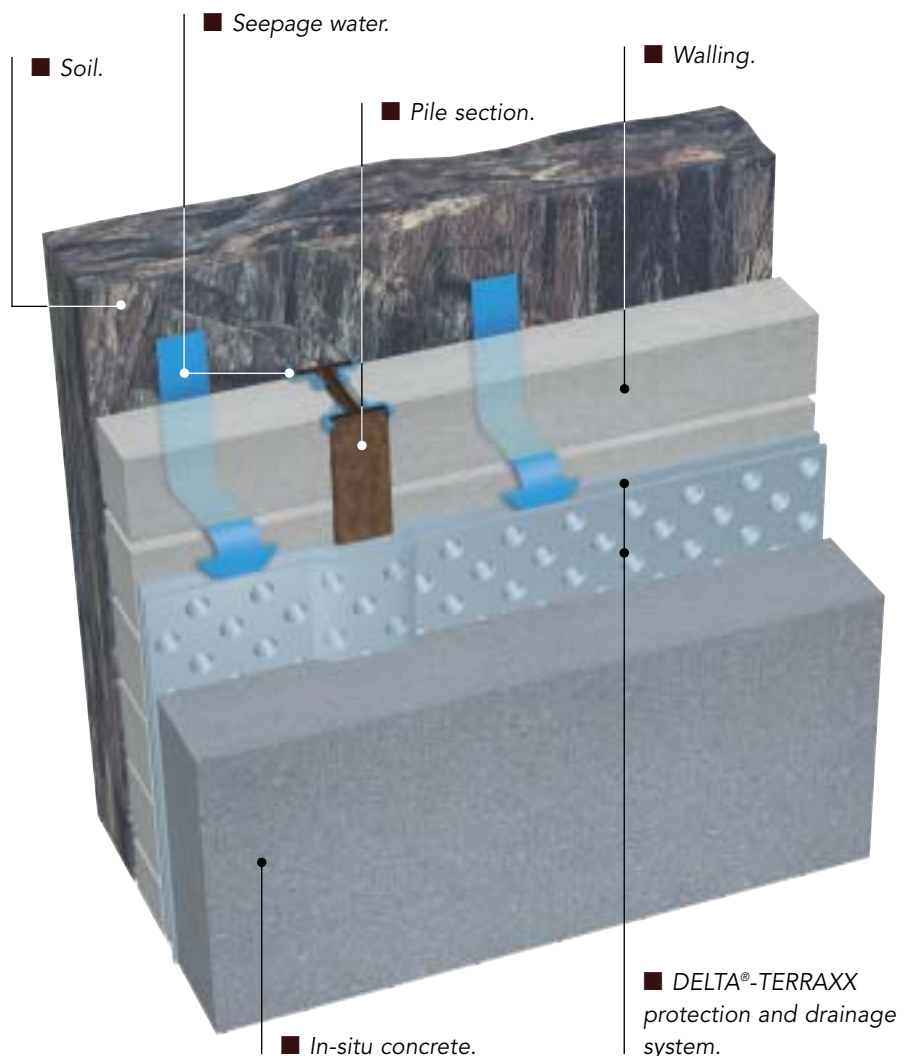

Civil-engineering Construction in Area

DELTA®-MS/DELTA®-MS 20.

The Situation:

When a new building is erected in the centre of a town or city, there is generally not enough room for allowing the sides of the excavation to slope naturally. Particularly on sites that are wedged in between two existing buildings, where every inch counts, excavation sides are normally shored up to keep the soil from subsiding. The walls that are used in these applications must be quick and economical to build, largely waterproof, and robust as well as safe, to avoid any danger to the neighbouring buildings.

Many clefting varieties absolutely call for high-performance drainage, for the seepage water traversing the lining under pressure will later on affect the waterproofing of the building itself and may even give rise to static problems under unfavourable conditions.

Curtain walls are made by pouring concrete into a trench 0.4 to 0.8 m in width that may be as deep as 40 meters. Specially-designed excavating tools are used for digging these trenches. Until they are filled with concrete, the earth walls encasing these trenches are kept from crumbling by a so-called supporting slurry consisting of bentonite and water. Like every other concrete wall that is cast on site, curtain walls may be penetrated by seepage water in the vicinity of beams or small cracks.



*The Duisburg underground:
DELTA®-MS 20 sheets installed between a reinforced curtain wall and the waterproof inner shell of the tunnel. This configuration permits structures to move without any unacceptable friction occurring between the curtain and the in-situ concrete wall.*

DELTA®-MS/DELTA®-MS 20: The Solution for Subterranean Curtain Walls or Shotcrete Linings.

DELTA®-MS and DELTA®-MS 20 may be installed as permanent shuttering either horizontally or vertically between a shotcrete wall and/or curtain wall and the concrete wall of the building. In this case, the shotcrete acts as a filter, keeping the seepage layer free from soil particles.

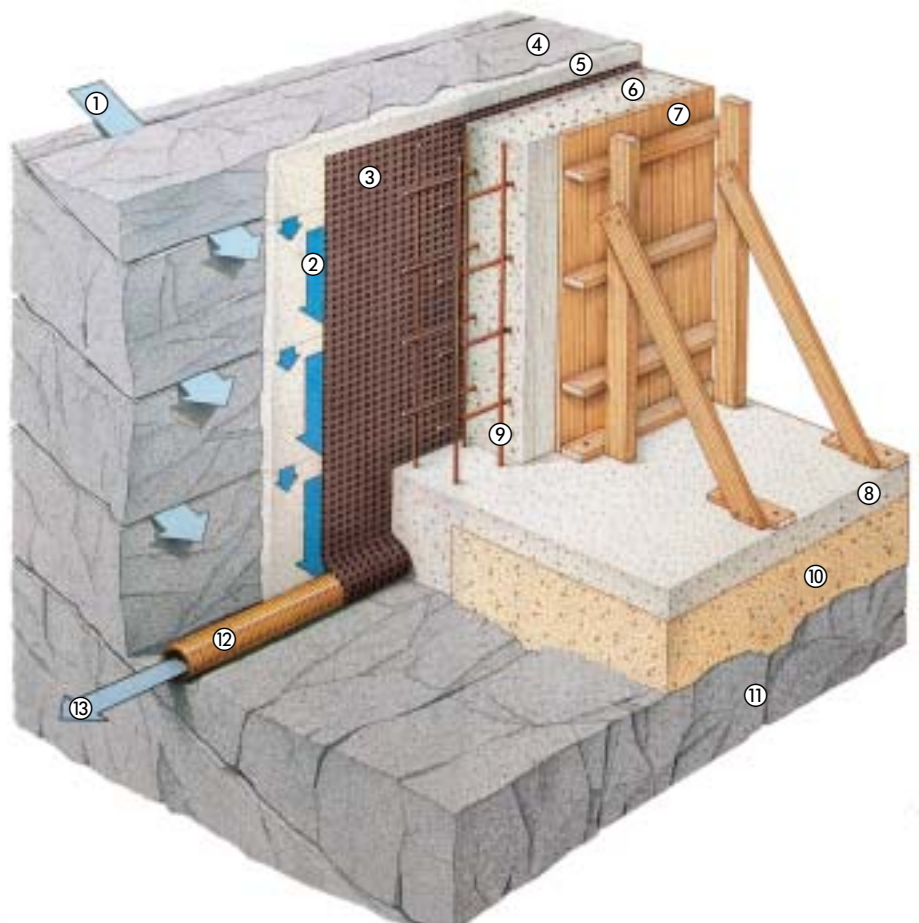

s Exposed to Underground Water.

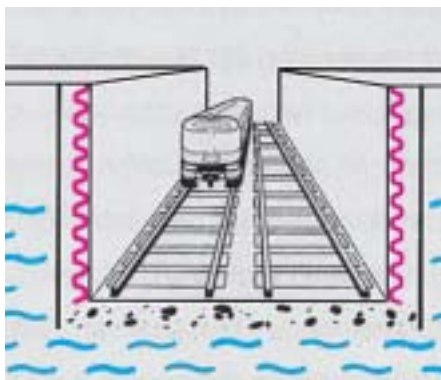

This approach permits controlled drainage of any water influx during the construction phase, so that it does not interfere with the setting process of water-impermeable and other concrete. Once the structure has been completed, any water influx will be drained away under no pressure, or else the groundwater tables will be raised to one and the same level all around the structure so as to ensure that all pressure-boundary waterproofing systems are exposed to the same hydrostatic pressure. Given a gradient of $i=1$, the drainage capacity of DELTA®-MS and DELTA®-MS 20 is 2.25 and 10 l/s · m, respectively.



Installed between the floor slab and the road surface, DELTA®-MS 20 catches any influx of water caused by rising groundwater levels, conveying it towards the drain pipe.

- ① Artesian water in the rock.
- ② Artesian-water drainage behind DELTA®-MS sheeting.
- ③ DELTA®-MS.
- ④ Rock.
- ⑤ Shotcrete.
- ⑥ Cast-in-place water-proof concrete:
The following serves as water-proofing of the building
 - Water-proof concrete.
 - Plastic sheeting.
 - Several layers of bituminous sheeting.
- ⑦ Shuttering.
- ⑧ Concrete shell.
- ⑨ Reinforcement mesh.
- ⑩ Compacted gravel mix.
- ⑪ Rock.
- ⑫ Drain pipe.
- ⑬ Outflow.



Underground garage of a Frankfurt hotel:
Water emerging from the rocky subsoil is drained away by a DELTA®-MS seepage layer.



European Building, Brussels:
The entire underground garage was put at risk by fluctuations in the groundwater level.

Systems for Underground Tunnel Construction

DELTA®-MS/DELTA®-MS 20.

The Situation:

Efficient drainage is of paramount importance while a tunnel is actually being built as well as after its completion. Depending on the ground and water configuration, the upper arch as well as the floor of the tunnel may be impacted by artesian, fissure, and – if the tunnel is covered by a thin layer of soil – seepage water. In the long run, both the durability and the usability of a tunnel largely depends on the extent to which its inner shell and floor have been reliably protected against the incursion of water and any subsequent frost damage. This being so, it is advisable to catch any artesian and surface water between the inner and the outer shell of the tunnel both along the arch and the floor of the tunnel in suitable drainage and seepage layers, and to drain it away under controlled conditions. This holds particularly true for any tunnels made by rationalised methods using waterproof concrete, which may neither come into contact with seepage water nor be exposed to hydrostatic pressure while it is setting.

DELTA®-MS: A Continuous and Safe System of Channels.

DELTA®-MS is a rational and reliable solution for coping with the influx of water in tunnel projects of any kind. Installed with its dimples facing outward, i.e. towards the rock substrate or a shotcrete layer applied for stabilisation and filtration purposes, the air gap between the dimples will form a continuous system of channels.

This air gap will convey any water coming from the ground towards the drainage system without impeding its flow. The inner waterproofing layer of the system, which may be attached directly to the dimpled sheet by any of a number of methods, is never impacted by water pressure. DELTA®-MS may serve as permanent shuttering in structures made of waterproof concrete, keeping away any seepage water while the material sets.

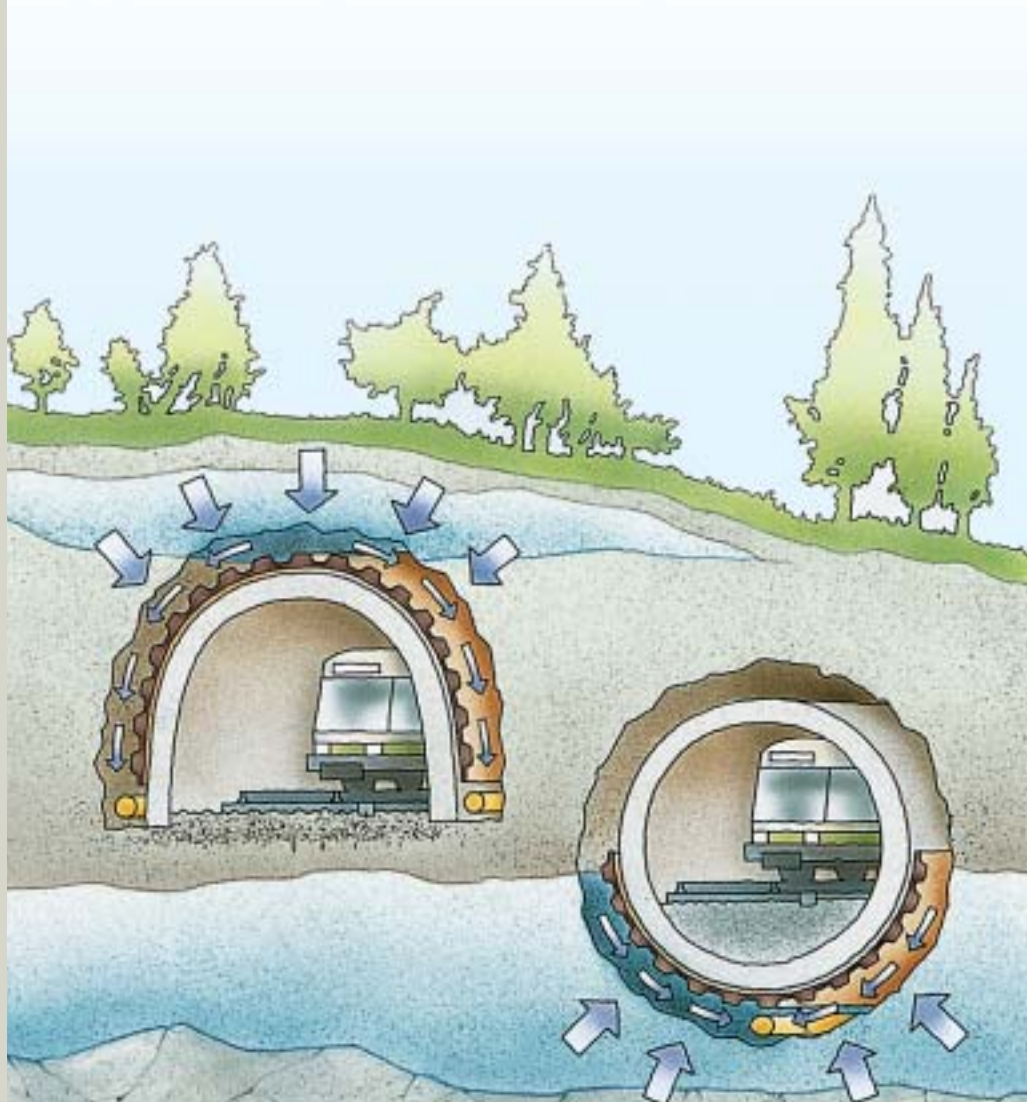

DELTA®-MS: the dependable solution for coping with water in tunnel projects of all kinds.

struction.

**DELTA®-MS 20:
A High Air Gap for Ample Reserve
Capacity.**

The drainage capacity of DELTA®-MS 20 is many times higher than that of DELTA®-MS, providing even more safety. Thanks to its thickness of 20 mm, the air gap offers high capacity reserves to cope with any cross-section reductions that may be caused by seepage in the course of time.



Thanks to its enormous drainage capacity, DELTA®-MS 20 offers outstanding safety.

Systems for Open Tunnel Construction.

DELTA®-TERRAXX.

The Situation:

Tunnel end sections or portals built above ground are exposed to water loading. As the backfill materials available on site frequently do not allow much seepage, drainage systems become indispensable.

DELTA®-TERRAXX: Powerful Protection against Headwater Pressure.

With its high compressive strength, the DELTA®-TERRAXX protection and drainage system guarantees effective elimination of any headwater pressure, even at active soil pressures of up to 90 kN/m².



System for Tunnel Rehabilitation.

DELTA®-PT.

The Situation:

Many older tunnels leak and since they have been inadequately waterproofed in the first place, structures do not only grow wet but may even lose their load-bearing capacity as the mortar in the masonry joints leaches out. Especially in railway tunnels, it is often impossible to close the tunnel to traffic entirely for rehabilitation. The only alternative is to dismantle such tunnels track by track and rebuild them with shotcrete. However, this approach offers no opportunity of waterproofing the entire surface of the arch.

DELTA®-PT: Safe Drainage of Fissure and Artesian Water.

In many cases, retrofitting tunnels with a drainage system is the only way of effectively eliminating water damage. By lining the inside arch with DELTA®-PT, a dimpled sheet with a laminated-on plaster mesh, an air gap facing the tunnel wall is created through which fissure and artesian water drains away safely. The fused-on plastic mesh provides optimum adhesion for the shotcrete applied during the installation phase.

Practical Accessories for DELTA®-Systems in Civil-engineering and Tunnel Construction:

DELTA®-MS KNOFF

Together with conventional bolts shot from a gun, these washers are used to install DELTA® dimpled sheets and prevent tearing.

DELTA®-MS DÜBEL

Used to fasten sheets to hard substrates, such as granite.

DELTA®-THENE-BAND T 300

30cm wide, self-adhesive DELTA®-THENE strips to secure overlaps against leaching from waterproof and other concrete.

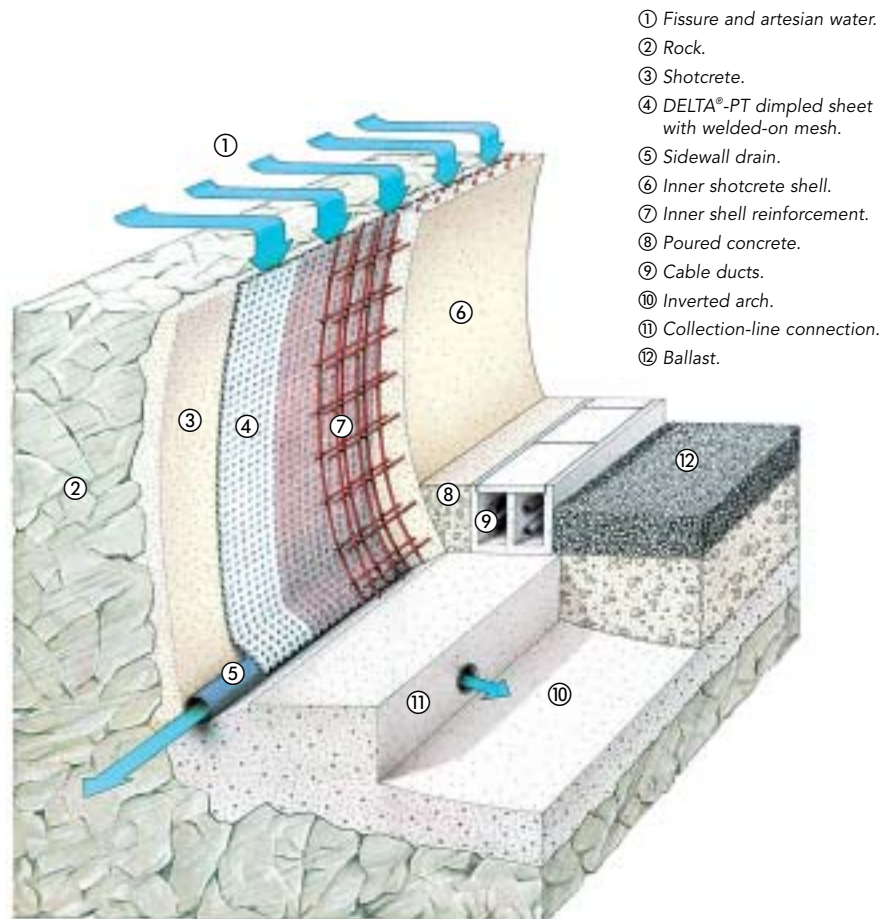

Technical Data Table.



Integrated self-adhesive tape for laying precision.



DELTA®-GEO-DRAIN TP 800 is highly compression-resistant.



Permanent filtration and drainage.

Dimpled drainage sheets		DELTA®-GEO-DRAIN Quattro	DELTA®-GEO-DRAIN TP 800	DELTA®-TERRAXX
Dimpled sheet		HDPE brown	HDPE brown	HDPE silver
Filter cloth		PP grey	PP grey	PP grey
Slipsheet		PE brown	–	–
Twist-woven mesh		–	–	–
Flat edge/ self-adhesive overlapping edge		Yes/yes	Yes/no	Yes/yes
Dimple height		ca. 9 mm	ca. 9 mm	ca. 9 mm
Air gap		ca. 7.7 l/m ²	ca. 7.9 l/m ²	ca. 7.7 l/m ²
Contact surface dimple/ground		ca. 10.000 cm ² /m ²	ca. 8.000 cm ² /m ²	ca. 8.000 cm ² /m ²
Compressive strength (transient loading)		ca. 400 kN/m ²	ca. 650 kN/m ²	ca. 400 kN/m ²
Compressive strength (permanent loading)		ca. 90 kN/m ²	ca. 200 kN/m ²	ca. 90 kN/m ²
Max. installation depth		10 m	20 m	10 m
Service temperature range		-30 °C to +80 °C	-30 °C to +80 °C	-30 °C to +80 °C
Tensile strength	EN ISO 10319	6.0 kN/m	–	6.0 kN/m
Dynamic perforation resistance (Cone drop test)	EN 918	40 mm	–	40 mm
Opening size O90	EN 12956	150 µm	–	150 µm
Roll size		12.5 m x 2.0 m	12.5 m x 2.0 m	12.5 m x 2.4 m
Hydraulic properties				
Drainage capacity without compression in l/s · m (EN 12958)	i = 0,02	0.40	0.40	0.40
	i = 0,03	0.51	0.51	0.51
	i = 0,10	1.03	1.03	1.03
	i = 1,00	3.50	3.50	3.50
Drainage capacity under 20 kN/m ² pressure in l/s · m (EN 12958)	i = 0,02	0.32	0.32	0.32
	i = 0,03	0.42	0.42	0.42
	i = 0,10	0.84	0.84	0.84
	i = 1,00	3.10	3.10	3.10



DELTA®-DRAIN keeps foundation walls dry and provides extra heat insulation.



DELTA®-NP DRAIN ensures reliable drainage.



DELTA®-MS is easy to lay, providing safety and protection for foundation walls.



Installed in cavity walls, DELTA®-MS 20 provides reliable drainage.



Simply apply plaster with a trowel.

DELTA®-DRAIN	DELTA®-NP DRAIN	DELTA®-MS	DELTA®-MS 20	DELTA®-PT
HDPE brown, with two-way dimples	PEHD brown	PEHD brown	PEHD brown	PEHD translucent
PP grey	PP grey	–	–	–
–	–	–	–	–
–	–	–	–	PE
No/no	Yes/no	Yes/no	No/no	Yes/no
ca. 12 mm	ca. 8 mm	ca. 8 mm	ca. 20 mm	ca. 8 mm
ca. 6.0 l/m ² /side	ca. 5.3 l/m ²	ca. 5.3 l/m ²	ca. 14.0 l/m ²	ca. 5.5 l/m ²
ca. 1.100 cm ² /m ²	ca. 5.500 cm ² /m ²	ca. 1.450 cm ² /m ²	ca. 1280 cm ² /m ²	ca. 935 cm ² /m ²
ca. 150 kN/m ²	ca. 150 kN/m ²	ca. 250 kN/m ²	ca. 150 kN/m ²	ca. 70 kN/m ²
ca. 50 kN/m ²	ca. 70 kN/m ²	ca. 90 kN/m ²	–	–
5 m	7 m	10 m	–	–
-30 °C to +80 °C	-30 °C to +80 °C	-30 °C to +80 °C	-30 °C to +80 °C	-30 °C to +80 °C
6.0 kN/m	–	–	–	–
40 mm	–	–	–	–
150 µm	–	–	–	–
12.5 m x 2.0 m	20 m x 2.0 m/12.5 m x 3.0 m	20 m x 1.0/1.5/2.0/2.4/3.0 m	20 m x 2.0 m	20 m x 2.0 m
0.15	0.21	0.21	1.45	0.60
0.21	0.28	0.28	1.75	0.73
0.47	0.61	0.61	3.20	1.36
1.75	2.25	2.25	10.00	4.39
0.14	0.20	0.20	1.17	0.41
0.19	0.26	0.25	1.43	0.51
0.42	0.50	0.57	2.64	1.00
1.50	1.90	2.06	8.40	3.60

Technical Data Survey.



DELTA®-PROTEKT – the universal EVA dampproof course.



Long-term protection for foundation walls and masonry.

Product designation	DELTA®-PROTEKT	DELTA®-MAUERWERKSSPERRE
Material	Ethylene vinyl acetate terpolymer (EVA) sheet	Polyolefin sheet
Colour	Grey	Black
Surface	Rough, slightly chequered	Chequered
Thickness incl. profile	ca. 1.2 mm	ca. 0.4 mm
Tear strength as per DIN 16726	Longitudinal: ca. 650 N/5cm Transversal: ca. 600 N/5cm	Longitudinal: ca. 150 N/5cm Transversal: ca. 100 N/5cm
Low-temperature creasing resistance as per DIN 16726	No breaks, no cracks	No breaks, no cracks
Resistant to	Bitumen	Bitumen
Water column	4 m, 72 h	4 m, 72 h
Width	11,5/17,5/24/30/36,5/50/75/100/150 cm	11,5/17,5/24/30/36,5/50/60/75/100/150 cm
Roll length	25 m	25 m

DELTA®-THENE Technical Data.



Reliable cellar wall protection.

DELTA®-THENE	Properties
Material	Cross-laminated special HDPE sheet with a bitumen-rubber waterproofing and adhesive layer
Thickness	ca. 1,5 mm
Weight	ca. 1,6 kg/m ²
Service temperature range	-30 °C to +80 °C
Working temperature range	+5 °C to +30 °C (air and ground) as low as -5 °C in combination with DELTA®-THENE low-temperature primer
Width	1 m
Length	5 m/20 m
Storage	Transport and store upright
Disposal	EWC Code 1 703 02 Asphalt, tar-free
Packaging	Reusable

DELTA®-THENE		Requirements as per DIN 18195-2: 2000-08, Table 10	Results	
			x	s
Outward appearance		Smooth surface without cracks or wrinkles	Smooth surface without cracks or wrinkles	
Water permeability		Waterproof	Waterproof	
Tensile strength	Longit.	≥ 200 N/50 mm	264 N/50 mm	13 N/50 mm
	Transv.		314 N/50 mm	9 N/50 mm
Elongation at break	Longit.	≥ 150 %	291 %	14 %
	Transv.		196 %	8 %
Tear propagation performance	Longit.	≥ 60 N	77 N	4 N
	Transv.		72 N	3 N
Low-temperature flexibility	Longit.	≤ -30 °C	≤ -30 °C	
	Transv.		≤ -30 °C	
Heat resistance		≥ 70 °C	≥ 70 °C	
Crack bridging at 2 mm displacement		≥ 5 mm	≥ 5 mm	
Thickness	Mean	≥ -1,5 mm	1,50 mm	0,03 mm
	Minimum		1,47 mm	
	Maximum		1,54 mm	
Seam peeling resistance		–	81 N/50 mm	1 N/50 mm
Backing sheet	Material	HDPE	HDPE	
	Thickness	≥ 0,07 mm	0,107 mm	0,002 mm
Water vapour diffusion equivalent, air gap thickness S_d		–	ca. 430 m	

x = arithmetical mean
s = standard deviation

List of Accessories for Foundation-wall and Waterproofing.



DELTA®-GEO-DRAIN CLIP
Attachment clip for fastening DELTA®-GEO-DRAIN Quattro and DELTA®-TERRAXX sheets easily and quickly. Also serves to attach DELTA®-NOPPEN-BAHNEN-PROFIL.



DELTA®-NOPPENBAHNEN-PROFIL
Moulding cap that serves to protect the upper edge of drainage sheets from dirt and mud.



DELTA®-TERRAXX-SCHRAUBE
For fastening DELTA® drainage sheets to perimeter insulation boards quickly and easily.



DELTA®-TERRAXX-PROFIL
Moulding cap for application to insulation boards. Easily adjustable to suit all insulation thicknesses from 60 to 100 mm.



DELTA®-MS DÜBEL
Plastic percussion plug for attaching DELTA® drainage sheets.



DELTA®-MS KNOFF
Washer for securely fastening DELTA® drainage sheets.

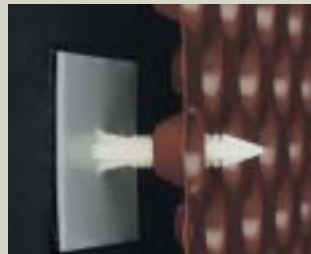

DELTA®-HAFTNAGEL
Adhesive pin to facilitate the installation of DELTA®-MS, DELTA®-DRAIN, DELTA®-TERRAXX, and DELTA®-GEO-DRAIN Quattro.



DELTA®-PT-PROFIL
Back-ventilation ceiling and floor cap for use with DELTA®-PT.

Protection, Drainage,



DELTA®-MAUERWERKSECKE
For easy facilitation of inside and outside corners effortlessly.



DELTA®-MWSP-CLIP
For easily fastening L-strips in cavity wall stone-faced masonry.



DELTA®-THENE GRUNDANSTRICH
A primer and adhesion promoter that easily penetrates mineral substrates. Solvent-based.



DELTA®-THENE-BAND T 300
Ready-cut DELTA®-THENE strips (0.3 x 10 m) for laying out DELTA®-THENE in corners, edges, hollow mouldings, and pipe apertures. Features split backing paper for easy processing.



DELTA®-DRAINAGEVLIES
Separation and filtration cloth provides filtration in wall drainage systems.



DELTA®-THAN
Permanently-elastic special rubber adhesive which comes in cartridges.

DELTA®-THENE KÄLTE-GRUNDANSTRICH
Winter primer specially designed for temperatures as low as -5°C.

DELTA®-BAND
Bitumen-rubber sealing tape with a powerful self-adhesive effect. With aluminium and/or lead-coloured cover.

Further Tools for Fastening DELTA® Dimpled Sheets.

■ Nail guns made by HILTI (Type DX 36 M or DX A41) or SPIT (Type SPIT P 60, with bevelled muzzle).

■ The following nails may be used: HILTI DNI 37 P8 and SPIT CR 9/40.

■ On particularly hard material, plastic washer plugs may be used instead of nails. Next to the DELTA®-MS DÜBEL, the following products may be used: HILTI type IDP O/2, SPIT type DSH 40, FISCHER type DHK 40, and UPAT type IMD 8/30-40.

■ HILTI as well as SPIT offer ready-made nail and washer assemblies. As these nails are easier to use, they should be given preference. Type designations include: HILTI DNI 32 P8 S15, HILTI X-DNH 37 P8 S15, HILTI X-SW, diameter 30 mm, and SPIT C 9/40 R21.

■ Floor and ceiling ends may be insulated using a HILTI DX 460 together with X-IE 6-60 CR72 insulation fasteners (length may vary with the thickness of the insulation material).

Performance Characteristics of DELTA® Dim

Every Effect Has its Specific Cause.

As in all modern drainage systems, the drainage capacity of DELTA® dimpled sheets is influenced by compressive loads. When exposed to pressure, all drainage materials will be compressed to a greater or lesser extent. Pressure loads that are of relevance in the practical application of dimpled sheets may be either transient (caused e.g. by shuttering) or permanent (e.g. soil pressure).

Example:

When exposed to a pressure of 250 kN/m², DELTA®-GEO-DRAIN Quattro will be crushed by 12 %.

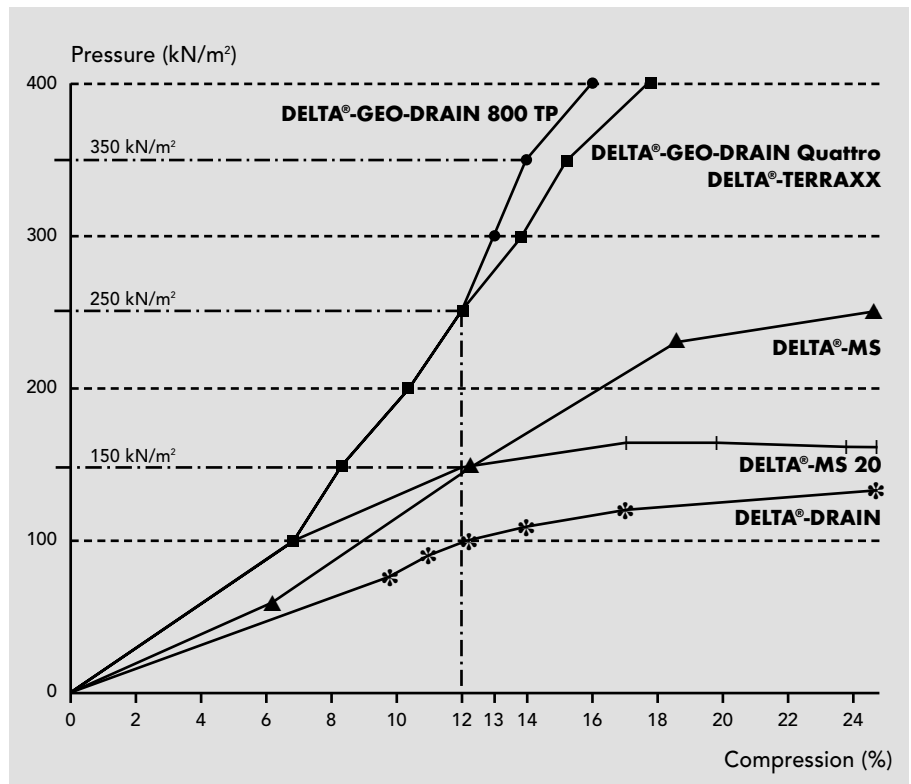

Compression of DELTA®-MS, DELTA®-MS 20, DELTA®-DRAIN, DELTA®-TERRAXX, DELTA®-GEO-DRAIN Quattro and DELTA®-GEO-DRAIN 800 TP under pressure, based on short-term tests.

Impact of Freshly-poured Concrete (Transient Loading).

The pressure exerted by freshly poured concrete largely depends on the consistency of the material and the rate at which it rises as it is poured. Pressure from freshly-poured concrete disappears as soon as the material has set.

Example:

Concrete belonging to the F2 consistency class that is poured at a rate of 5 m/h will exert pressure amounting to about 60 kN/m² on the shuttering. Under these conditions, the water-drainage capacity of DELTA®-DRAIN will be about 1,6 l/s · m.

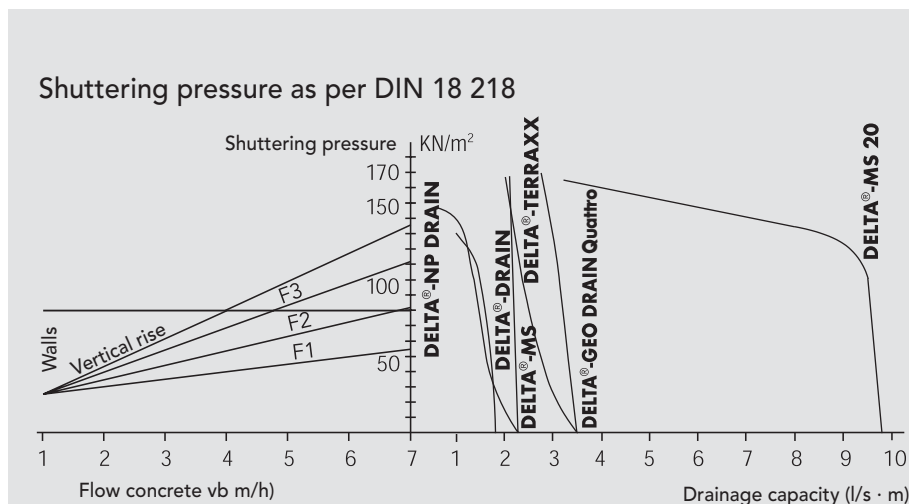

Drainage capacity of DELTA®-MS, DELTA®-MS 20, DELTA®-DRAIN, DELTA®-TERRAXX and DELTA®-GEO-DRAIN Quattro under shuttering pressure (diagram follows DIN 18218).

mpled Sheets.

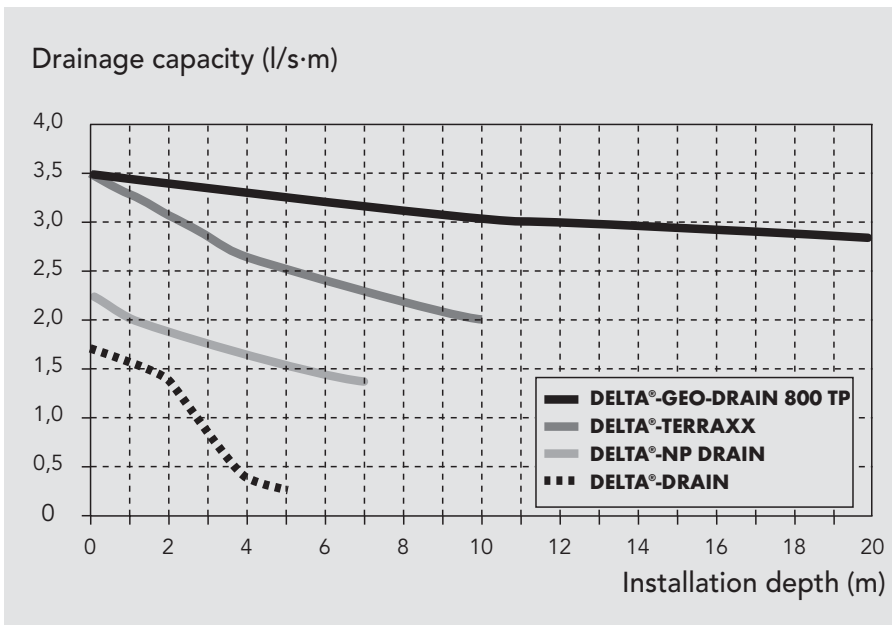

Drainage capacity versus installation depth and/or soil pressure for DELTA®-GEO-DRAIN 800 TP, DELTA®-TERRAXX, DELTA®-NP DRAIN and DELTA®-DRAIN, based on long-term tests.

Soil Pressure (Permanent Loading).

Acting permanently on the structure of a building, soil pressure depends on installation depth. Drainage-capacity figures shown in the diagram are based on long-term tests extrapolated to show the condition of the sheets after 50 years of use.

Example:

When installed at a depth of 3 m, the water-drainage capacity of DELTA®-TERRAXX amounts to 2,8 l/s · m.

What DELTA®-System Fits What Application

Application	DELTA®-PROTEKT	DELTA®-MAUER-WERKSSPERRE	DELTA®-MS	DELTA®-MS 20	DELTA®-GEO-DRAIN Quattro
Horizontal waterproofing					
Footing dampproof courses	■	■			
L- and Z-barriers in cavity walls	■				
Dampproof course for post and beam structures	■				
Surface waterproofing					
Waterproofing for vertical brick or concrete cellar walls					
Vapour barrier for vertical cellar walls made of waterproof concrete					
Expansion-joint waterproofing for three-leaf vertical cellar walls					
Surface waterproofing for horizontal concrete floor slabs					
Waterproofing for shower cubicles					
Vertical protection and drainage					
Compr.-sensitive rubber-bitumen waterproofing					■
Compression-sensitive rubber-bitumen waterproofing and perimeter insulation			■ *1		
Horizontal protection and drainage					
Compr.-sensitive rubber-bitumen waterproofing					■
Compression-resistant waterproofing					
Reversible roof insulation					
Gas drainage					■
Rehabilitation from inside (damp walls)					
Alternative sub-base course for floor slabs without static loading			■		
Civil engineering					
Seepage layers on curtain walls and shotcrete linings			■	■	
Drainage layer for "Berlin" timber walls					
Protection against flooding				■	
Tank foundations				■	
Green-roof system				■ *2	
Tunnel building					
Construction, inside drainage			■	■	
Construction, outside drainage					
Rehabilitation					

*1 Only in conjunction with a vertical gravel layer

*2 DELTA®-MS 20, perforated.

ion?

Application	DELTA®-TERRAXX	DELTA®-DRAIN	DELTA®-THENE	DELTA®-PT	DELTA®-NP DRAIN	DELTA®-GEO-DRAIN 800 TP
Horizontal waterproofing						
Footing dampproof courses						
L- and Z-barriers in cavity walls						
Dampproof course for post and beam structures						
Surface waterproofing						
Waterproofing for vertical brick or concrete cellar walls			■			
Vapour barrier for vertical cellar walls made of waterproof concrete			■			
Expansion-joint waterproofing for three-leaf vertical cellar walls			■			
Surface waterproofing for horizontal concrete floor slabs			■			
Waterproofing for shower cubicles			■			
Vertical protection and drainage						
Compr.-sensitive rubber-bitumen waterproofing						
Compression-sensitive rubber-bitumen waterproofing and perimeter insulation	■	■			■	■
Horizontal protection and drainage						
Compr.-sensitive rubber-bitumen waterproofing						
Compression-resistant waterproofing	■				■	■
Reversible roof insulation		■				
Gas drainage	■					■
Rehabilitation from inside (damp walls)				■		
Alternative sub-base course for floor slabs without static loading						
Civil engineering						
Seepage layers on curtain walls and shotcrete linings						
Drainage layer for "Berlin" timber walls	■				■	■
Protection against flooding						
Tank foundations						
Green-roof system						
Tunnel building						
Construction, inside drainage						
Construction, outside drainage	■				■	■
Rehabilitation				■		

DELTA®



Dörken GmbH & Co. KG
Wetterstraße 58
58313 Herdecke
Tel.: 0 23 30/63-0
Fax: 0 23 30/63-355
bvf@doerken.de
www.doerken.de

A member of the Dörken Group.

Delta Membrane Systems Ltd.
Delta House
Merlin Way
North Weald, Epping
Essex CM16 6HR
Tel.: 01992 523523
Fax: 01992 523250
E mail: info@deltamembranes.com