

Instructions for Use

For Automatic Folding Door System
in Escape and Rescue Routes

TORMAX iMotion® 4251.R Folding Door System



Safety instructions in chapter 2 must be observed!

Contents

1	General Information	3
1.1	Target Groups	3
1.2	Storage and Forwarding of the Manual	3
1.3	Area of Application	3
1.4	Explanation of the Symbols	4
1.5	Technical Data	4
2	Safety	5
2.1	Responsibilities	5
2.2	Intended Use	5
2.3	Improper Use	6
2.4	Pre-conditions for the Operation of the System	6
2.5	Hazards and Risks	7
2.6	Checks	7
2.7	Decommissioning the System in the Event of a Fault	8
2.8	Disposal	8
3	System Overview	9
4	System Functions	11
4.1	Escape Route Function	11
4.2	Control of the Operating Modes (see also 5.2)	11
4.3	Automatic Door Operation with Sensors	11
4.4	Traffic Control	11
4.5	Automatic System Monitoring	12
4.6	Electromechanical Locking	12
4.7	Operating Modes	13
5	Operation	14
5.1	Commissioning	14
5.2	Selecting the Operating Mode	14
5.3	Operation in Case of Power Failure	16
6	Procedure in the Event of a Fault	17
7	Maintenance	18
7.1	Cleaning	18
7.2	Functional Checks	18
7.3	Maintenance and Testing	18
8	Appendix	19
8.1	Fault Table	19
8.2	Check-list for Functional Checks	22
	Declaration of Conformity	23

First edition: 2.20

We reserve the right to make technical changes.

1 General Information

1.1 Target Groups

- Operator of the automatic folding door. The operator is the person responsible for the operation and maintenance of the system.
- Persons instructed by the operator to carry out certain duties, for example the operation or maintenance of the automatic folding door.

1.2 Storage and Forwarding of the Manual

- Store the instructions for use in the vicinity of the automatic door system.
- If the manual has become illegible due to constant usage, reorder the instructions or download from: www.tormax.com
- When the door system is transferred or resaled to a third party, pass the following documents to the new owner:
 - This instructions for use
 - Documentation concerning modification and repair work
 - Proof of the regular examinations → System test book T-879

1.3 Area of Application

Product name, door system: **TORMAX iMotion® 4251.R. Folding Door System**

Product name, door drive: **TORMAX iMotion® 4201.R. Folding Door Drive**

The drive designation is given in short form in the manual.

The door drives are defined by a 4-digit number.

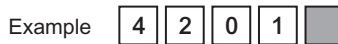

- 4 = Drive for folding door system
- 1 – 4 = Increasing power
- Continuous numbering

■ .R = Drive with auxiliary motor

Service label
door system (example)

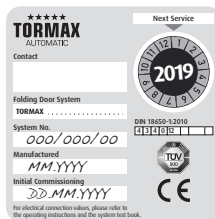

The service label is attached to the side plate of the drive

Identification plate
(example)

TORMAX AUTOMATIC TORMAX Unterweg 14 CH-8180 Bulach-Zurich A Division of Landert Group AG		
Model:		
Un:	Ta:	
Pmax:	Pedestrian Door Operator	
Imax:	Manufactured: MM/YYYY	
Fmax:	Serial No.:	

The identification plate with the serial number is attached to the drive.

1.4 Explanation of the Symbols



Warning (signal word)

Source of hazard (designates a possibly hazardous situation)

Possible consequences of non-observance

- Measures for averting danger.

Text which is highlighted in grey MUST be observed to ensure that the system operates perfectly. Failure to observe these sections can cause damage to equipment.

◆ Optional components which are not present in all systems.

1.5 Technical Data

Drive type	Electro-mechanical folding door drive with AC motor
Emergency opening system	Auxiliary motor
Control system	Control unit MCU32
Mains connection	1 × 230 V AC, 50–60 Hz, 10 – 16 A
Power consumption	max. 190 W
Sensor supply	24 V DC (+0,5–1,5 V) 0,75 A in battery operation min. 16,5 V
Protective class, drive	IP 20
Fuse	5 AT
Ambient temperature	–15 °C ... +50 °C
Noise emission level	Typically 50 db(A) at 50 cm/s
Electromagnetic compatibility (EMC)	IEC 61000-6-2, IEC 61000-6-3
Durability	1 000 000 cycles testet

2 Safety



Warning

Important safety instructions

It is important to follow these instructions to ensure the safety of persons. These instructions should be kept available.

2.1 Responsibilities

For instructing the operator:	A specialist from a TORMAX sales partner
For operating the system:	The operator or a person instructed by the operator
For maintenance and function control:	The operator or a person instructed by the operator
For annual testing and approval:	A specialist authorised by the manufacturer

Specialists are persons who have adequate knowledge in the field of power-operated doors as a result of their specialist training and experience and who are so familiar with the relevant health and safety regulations, guide-lines and generally recognised codes of practice that they are able to assess the condition of power-operated doors with regard to the safety of their operation. Maintenance of electrical parts must be carried out by a trained electrician.

2.2 Intended Use

The product including the associated components is intended for the automation of horizontally moving folding doors for pedestrian thoroughfares.

The drive may only be installed inside or on the inside of buildings in dry premises.

When in the "FRW ON" state, the system serves as an escape and rescue route (see also chapters 4.7 and 5.2). The escape route must be kept clear at all times. Avoid any restriction or obstruction of the escape route and its stipulated passage width.

- Assembly, installation, repair and maintenance work as well as commissioning must be undertaken by a specialist.
- The folding door must only be operated by a person who has been appropriately trained and who must follow the Operating Instructions.
- The door system may be used by persons with impaired physical, sensory or mental capabilities provided that they are either supervised by the person responsible for their safety or have been instructed in the safe use of the system and the potential hazards.
- Children must be supervised to ensure that they do not play in the vicinity of the door and do not operate the controls on the door.

2.3 Improper Use

The manufacturer will not accept any liability whatsoever for damage caused by improper use, failure to comply with the maintenance specification (see chapter 7) or unauthorised modification of the system.

- Any conversion of the system (e.g. a different user group) is not permitted without a new risk assessment (by a specialist) and the implementation of measures derived from this assessment.
- Structural changes in the danger zone of the door system are not permitted without a new risk assessment (by a specialist) and the implementation of measures derived from this assessment.
- Modifications to the door system (e.g. different, heavier door leaves, different operating components and sensors) may only be undertaken by a specialist and the technical limit values must not be exceeded.
- Safety facilities (e.g. sensor technology, manual unlocking) must not be removed or disabled.
- Cleaning and maintenance by the operator must not be undertaken by children.

Other types of improper use (examples)

- Automatic doors with door leaves that are moved in a vertical or inclined direction.
- Automatic doors and gates used in transport equipment (e.g. vehicles, lifts)
- Door systems incorporating a wicket door must not be automated.
- The drive must not be used as a drive for a wicket door.
- Use in abrasive or corrosive environments or in areas where there is a risk of explosion.

2.4 Pre-conditions for the Operation of the System

The door system was designed, installed and checked for functionality and safety by specialists prior to hand-over to the operator. The company responsible for the system's installation instructed the operator on the system's use and maintenance as well dangers associated with the system operation. The operator has confirmed this by his signature in the system test book T-879.

The provisions imposed by law, health and safety and occupational health regulations for the avoidance of accidents and the protection of the environment which are generally applicable in the country in which the system is operated supplement the instructions for use.

- The person responsible (see chapter 2.1) must have read and understood these Operating Instructions before the door system is commissioned and used.
- Only use the system when it is in perfect working order. The operating conditions, inspection and maintenance intervals stipulated by the manufacturer must be observed (chapter 7).
- Arrange to have any faults rectified immediately by a specialist.

2.5 Hazards and Risks

Depending on the system design and equipment, there is a residual risk of crushing (1) and collision (2) in the movement area of the door leaves – albeit with restricted force.

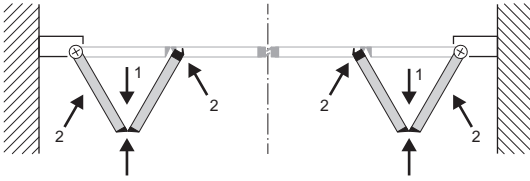

Warning

Danger through moving parts:

- in the area of all closing edges
- in the gap for suspending the door in the cladding
- when objects such as, for example, display shelves are erected in the direct proximity of the moving part of the door leaf.



Warning

Hazards can arise due to deliberate damage, incorrect installation, defective sensors or sensors which are longer properly adjusted, sharp edges, incorrectly mounted and defective casing or missing covers.

Danger for body and life, danger of injury

- Have system repaired by a qualified person.

2.6 Checks

The regular checks and examinations set out in chapter 7 must be carried out as instructed by the manufacturer.

2.7 Decommissioning the System in the Event of a Fault

If there is a fault the automatic folding door may only be taken out of service by a specialist, the operator or a person who is instructed to do so by the operator. This must be done on all occasions on which the safety of persons could be compromised.

- Disconnect the system from the power supply. The all-pole mains disconnection takes place via a 3-pin IEC plug or another all-pole disconnecting device (eg in the fuse box).
- If the system includes another power source (e.g. a battery ) this must be disconnected from the system by a specialist.

See chapters 6 and 8 for rectification of faults.

In the “FRW ON” state



The door opens automatically if a safety-relevant fault occurs.

- Leave the door open as long as it serves as an escape and rescue route.
- Leave the FRW key switch in the “FRW ON” position as long as the system is to serve as an escape and rescue route (for operation of the FRW key switch, see chapter 5.2).

In the “FRW OFF” state



With locking mechanism: The door remains closed and locked when a safety-relevant fault occurs.

2.8 Disposal

This system must be properly dismantled at the end of its working life. Its disposal must comply with national regulations. We recommend that you contact a specialist disposal company.



Warning

Aggressive acids

Risk of injury if you dismantle the battery module.

- Dispose of batteries properly.



Warning

Broken glass

Risk of injury when dismantling the door leaves.

- Take care when transporting the door leaves.

3 System Overview

Folding door system for internal and external applications.

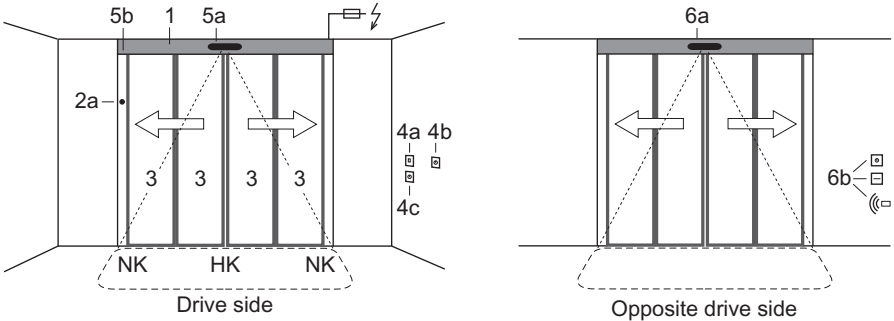

T1905_2e

1	Drive	Cladding Motor unit (primary motor, auxiliary motor) MCU32 control system with monitoring system, power limitation and permanent diagnosis Guide system with noise-absorbent guide rail
2	Drive accessories	Electrical lock a) <input type="checkbox"/> Internal manual disengagement Emergency power supply via the battery unit
3	Door leaf	a) Moving leaves with main closing edge (HK) and secondary closing edge (NK)
4	Operating controls	a) User interface with 6 operating modes and fault display b) <input type="checkbox"/> FRW key switch or c) <input type="checkbox"/> FRW spring return key switch
5	Activators drive side	a) FRW radar with direction recognition, redundant * a) <input type="checkbox"/> Presence sensor *: Protection of secondary closing edge
6	Activators opposite drive side	a) With automatic activation <input type="checkbox"/> Combined sensor (activator/safety) b) With manual activation <input type="checkbox"/> Key switch * <input type="checkbox"/> Card reader * <input type="checkbox"/> Remote control *
7	Output message	<input type="checkbox"/> Bell/gong * <input type="checkbox"/> Light/ventilation * <input type="checkbox"/> Door locked <input type="checkbox"/> Door status

Depending on the system's equipment

* Not offered by TORMAX. The company installing the system must select and install suitable components as defined in the product specification EN16005/DIN18650.

Block diagram

All work on the power supply cable and the system cabling must be undertaken by an authorised specialist and follow the necessary documents.

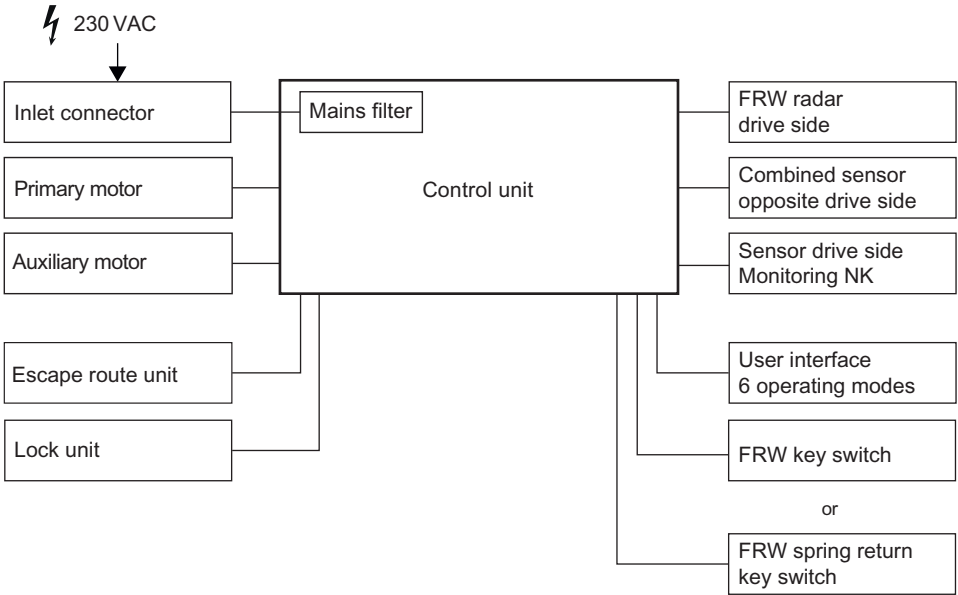

T1905_1e

4 System Functions

4.1 Escape Route Function

The automatic door system can be walked through in the direction of escape at any time when it is in the „FRW ON“ state in operating modes AUTOMATIC 1/2, EXIT or OPEN. The escape route function is not available when the system is in the “FRW OFF” state in the operating modes OFF or manual.

The operator of the system is responsible for ensuring that the escape route is freely accessible for passing through at all times. In particular, it must be ensured that the travel path of the folding door leaves is not blocked by any objects in the way.

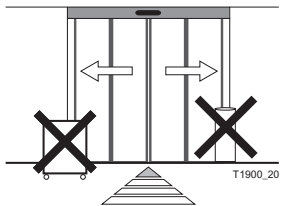

4.2 Control of the Operating Modes (see also 5.2)

The automatic door system is operated

A via the TORMAX user interface and the FRW key switch

or

B via the TORMAX user interface and the FRW spring return key switch

or

C via the TORMAX user interface with code lock.

4.3 Automatic Door Operation with Sensors

When operating automatically (operating mode AUTOMATIC) the door is automatically opened from both sides by sensors (in escape route direction via FRW radar) when a person approaches.

A key switch ♦ or card reader ♦ normally allows access from outside when the door is in operating mode EXIT or OFF. The door unlocks, opens and closes again as soon as no further sensors are activated after a hold-open time which is set separately.

The sensors for the door opening and the maintained opening of the door are arranged and adjusted in such a way that the door opens promptly and remains open as long as a person is within the operating range of the door leaves. Only after a presence time of approx. > 1 minute can the door still close.

The reduced closing speed set by the installer, which is adapted to the weight of the door, combined with a force of < 150 N, prevents the moving leaves from hitting a person too hard. The obstruction is also detected by the control system and the door automatically reverses.

4.4 Traffic Control

Movement through the door can be allowed in only one direction if desired (operating mode EXIT) or completely blocked (operating mode OFF).

In order to protect against environmental influences (wind/cold/heat) the door can be operated in operating mode AUTOMATIC 2 with a restricted opening width which is not less than the required escape route width.

4.5 Automatic System Monitoring

The control system monitors the safety sensors by a cycle of active tests. The control system also conducts continuous internal system tests.

The emergency opening systems are tested periodically. After switching from OFF (FRW OFF) to AUTOMATIC ("FRW ON"), an emergency opening test (display: H38) is automatically performed. After a further 12 hours, an emergency opening test is automatically included during the next regular door opening (display: H38). After 24 hours of continuous operation in the "FRW ON" state, an automatic test opening is carried out (display: H38).

If a safety-relevant component fails, the system automatically switches to a safe state and opens in the "FRW ON" state. The fault number is displayed on the user interface. For further details, see chapter 6 "Procedure in case of malfunction".

4.6 Electromechanical Locking

The system can be locked in the "FRW OFF" state by means of an electromechanical locking device and can optionally also be blocked in the "EXIT" operating mode by a holding brake \blacklozenge in closed position with a force of approx. 600 N.

The locking mechanism is monitored. Any malfunction during operation of the locking mechanism can thus be immediately shown on the user interface. For details, see chapter 6 "Procedure in case of malfunction".

In the event of a power cut, the locking mechanism can be operated directly via the optional manual release.

Function in the Case of Power Failure While in the "FRW ON" State in AUTOMATIC 1, 2, EXIT

- The door opens immediately. The system continues to operate for a certain time via a battery module before it then opens automatically and remains in the open position.

4.7 Operating Modes



State “FRW OFF”

While in the “FRW OFF” state the system cannot be used as an escape and rescue route!



Operating mode OFF, state “FRW OFF”

The impulse devices (sensors) inside and outside are not observed when the door is in the closed position. The door is kept closed by a motor or the holding brake , and/or locked by the electromechanical locking device. Access is only possible by using the key switch.

After selecting the operating mode OFF, the door can still be used from inside to outside for 5 seconds. The transition is indicated on the user interface by the flashing display of operating mode OFF.

P Operating mode for manual operation, state “FRW OFF”

The door leaves can be moved freely. This operating mode can be used to clean the door leaves or to temporarily shut down the system. After leaving operating mode P, the system performs a restart with calibration run (H61, H62) and subsequent test opening (H38).



State “FRW ON”

While in the “FRW ON” state the system can be used as an escape and rescue route in all the operating modes that can be selected under “FRW ON”.



Operating mode AUTOMATIC 1, state “FRW ON”

The operating mode AUTOMATIC 1 is usually used for normal daily operation. The door opens automatically from both sides via the sensors inside and outside, and usually to the full opening width.



Operating mode AUTOMATIC 2, state “FRW ON”

The operating mode AUTOMATIC 2 is usually used for normal daily operation. The door opens automatically from both sides via the sensors inside and outside, and usually to a reduced width of opening. In this case the minimum escape route width must be observed. If required, a different hold-open time can be set by the technician, other than AUTOMATIC 1.



Operating mode EXIT, state “FRW ON”

The operating mode EXIT is usually used for operation at the end of the day before business closes. The door only opens automatically from the inside, via the inside sensor. While the door is opening, the outside sensor is also active and used for safety reasons.

The opening width is determined by the previously selected operating mode AUTOMATIC 1 or AUTOMATIC 2. The door can be locked in place automatically by the holding brake . EXIT mode cannot be selected when the passage is being used as an escape route in both directions.



Operating mode OPEN, state “FRW ON”

The door opens and remains open. The opening width is determined by the previously selected operating mode AUTOMATIC 1 or AUTOMATIC 2. It is recommended that one select the full opening width in order to provide the widest possible escape route.

5 Operation

The automatic folding door may only be operated by a specialist, the operator or a person instructed by the operator.

5.1 Commissioning

Before switching on the mains power supply:

- Check that the movement area of the door leaves is free from objects e.g. umbrella stands or vehicles.
- Switch on the mains power and select operating mode AUTOMATIC 1.
Operating mode AUTOMATIC 1 is displayed. If necessary, first switch to "FRW ON" state (see 5.2).

→ The first movement after switching the power on for the first time is slow. The control system is checking the door leaf's travel distance and defining the end position. Thereafter an emergency opening test is executed automatically and H38 is displayed.

→ The door is now ready for operation.

5.2 Selecting the Operating Mode

Switching between the states "FRW ON" and "FRW OFF" may only be carried out by the authorised person.

The switching is therefore protected by a key or a code.

The system is fitted with one of the operating variants A, B or C.

A Operation Using the FRW Key Switch and User Interface

The authorised person can select the states "FRW ON" and "FRW OFF" by turning the FRW key switch.

Selectable operating modes:

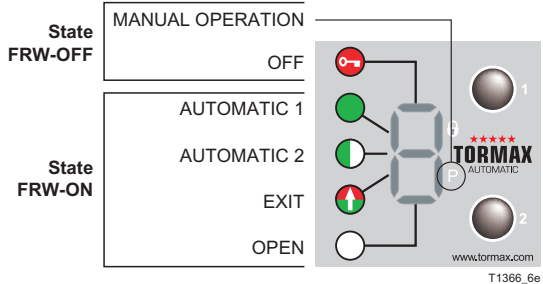
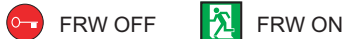
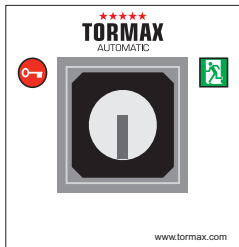

Optionally, the selection of the operating mode can be blocked 5 s after actuating the key switch.

Resetting of faults

See chapter 6 “Procedure in case of malfunction” and chapter 8.1 “Error table”.

The system can be restarted by pressing and holding the lower button (2) for 5 seconds.

B Operation Using the FRW Spring Return Key Switch and User Interface

The authorised person can switch between the “FRW ON/OFF” states by briefly flipping the FRW spring return key switch. The switch-over is indicated by an audible signal from the system and flashing of the operating mode.

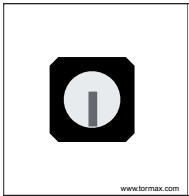

FRW spring return key switch

Selectable operating modes:

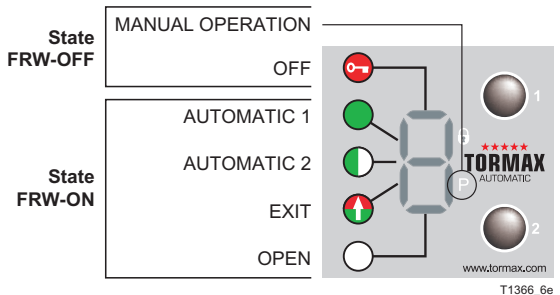

Optionally, the selection of the operating mode can be blocked 5 s after actuating the spring return key switch.

Resetting of faults

See chapter 6 “Procedure in case of malfunction” and chapter 8.1 fault table

The system can be restarted by pressing and holding the lower button (2) for 5 seconds.

C Operation using the FRW code lock and user interface

Selection of operating modes

The authorised person can unlock the TORMAX user interface by entering the code. All operating modes can then be selected directly on the user interface, within the next 60 seconds.

Your code:

Example with code 333

Press upper key 3 ×

Press lower key 3 ×

Press upper key 3 ×

Time allowed for input max. 15 s.

After an incorrect entry, wait at least 5 seconds.

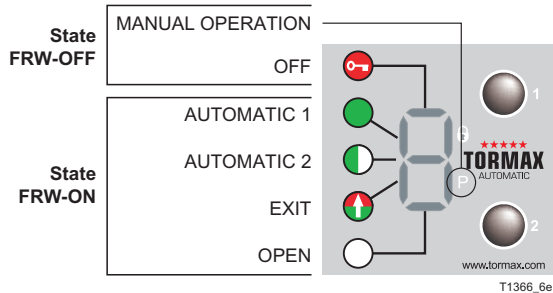

T1366_6e

Resetting of faults

See chapter 6 procedure in case of malfunction and chapter 8.1 fault table.

The system can be restarted by pressing and holding the lower button for 5 seconds.

5.3 Operation in Case of Power Failure

Closing and locking the door

- Push the sliding leaf by hand.
- Pull the sliding bolt by hand to the “locked” position.
- Turn the FRW key switch to “FRW OFF”.



When the power comes back on, the operating mode is automatically set to OFF due to the position of the locking bolt, and then the door remains locked in this case.

Manual unlocking ♦

- Actuate the manual release.



- Open the door manually



T1900_18

- If required, turn the FRW key switch to “FRW ON”.
→ When the power comes back on, the operating mode is automatically set to AUTOMATIC due to the position of the FRW key switch, and then the door is ready for automatic operation as an escape and rescue route.

6 Procedure in the Event of a Fault

Faults are evident from abnormal door behaviour and/or as an error message on the user interface. Error messages on the user interface take the form of a flashing "E" or "H" followed by two figures.

H = notification > the system can continue to be used.

E = fault > the system is stationary.

Some faults or notifications can be rectified by restarting the door drive with a software reset and/or briefly disconnecting the system from the power supply.

Fault Display and Reset Using the TORMAX User Interface

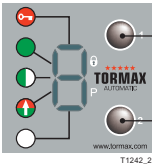

Browse through the fault display

1. Reset the error message, press selector key briefly.
2. Software reset: press the key for 5 seconds.

Resetting FRW faults by changing the operating mode

- Applies to display E70 – E77
- Set state to "FRW OFF" and then back to "FRW ON".

If this does not reset the fault or if it re-occurs after a short time, you must arrange for the fault to be rectified by a specialist from your TORMAX dealer. In this case note the fault number and inform the dealer. See the last page or the service tag on the system for the dealer's address.

A FRW key switch

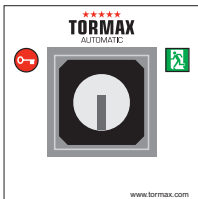

- FRW-ON
- FRW-OFF

B FRW spring return key switch

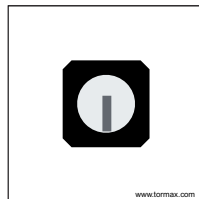

- Flip 2 x in succession until you hear a beep (after min. 3 s). The operating mode changes to OFF and back to AUTOMATIC.

C FRW code lock

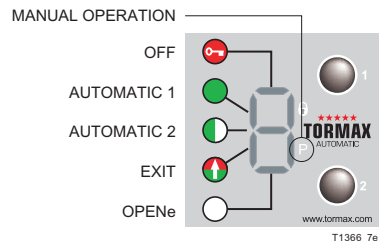

- Enter the code
- Set the operating mode to OFF and then back to AUTOMATIC.

7 Maintenance

The system was tested and approved by an expert before initial commissioning. The manufacturer recommends that you conclude a service contract in order to maintain the value of your system for as long as possible as well as to ensure the system operates reliably and safely for a long time.

Only genuine TORMAX spare part should be used. The manufacturer accepts no liability if you fail to observe this requirement. Original spare parts and original accessories guarantee the safety of use in accordance with norm EN 16005.



Warning

Potential injury hazard!

Entrapment of limbs can lead to serious injuries.

- The drive must be isolated from all power sources including batteries during cleaning and when replacing parts.

7.1 Cleaning

- Clean casing parts, the user interface and door leaves with a damp cloth and a commercial cleaner.

7.2 Functional Checks

Check the function and safety devices of the automatic folding door at least **every 3 months**.

This will ensure that faults or hazardous changes in the system are detected at an early stage. See chapter 8.2 "Check-list for Functional Checks" for items to be checked.

- You should arrange for any defects detected during the routine checks to be rectified immediately by a TORMAX dealer (see the last page of this Manual for the address).



Warning

Potential switching malfunction in the automatic folding door.

Potential hazards – injury caused by impact or crushing.

- Secure the door area when conducting function checks.

7.3 Maintenance and Testing

Maintenance and testing should only be carried out by a trained specialist following the manufacturer's instructions.

Maintenance Interval

The maintenance interval depends on the frequency of use but the system must be maintained at least **once per year**.

Scope of the Maintenance Work

The content of the maintenance work is specified by the manufacturer in an inspection list.

System Test Book

The test findings are recorded after the test in the system test book. The operator must keep it in a safe place.

8 Appendix



8.1 Fault Table

System Behaviour	No.	Cause	Remedy/ Rectification
Door system runs normally	H34	FRW spring return key switch is switched on for too long. > 5 s.	Reset FRW spring return key switch.
Door does not stop during test opening	H36	No magnetic switch signal.	Have the system repaired by a specialist.
Door opens and closes normally or only with 20 – 40 cm opening width.	H38	Normal test opening after switching to FRW ON or after software reset or after 24 hours in FRW ON.	Wait until the test opening is finished.
The door stops when opening.	H91	Electronic obstacle recognition on opening by a person, wind pressure or ventilation.	Remove the obstruction.
Door reverses when closing.	H92	Electronic obstacle recognition on closing by a person, wind pressure, ventilation or dirt in the floor guide.	Remove the obstruction.
The door stops repeatedly when opening.	H93	Repeated electronic obstacle recognition on opening by stationary obstacle.	Remove the obstruction.
The door stops repeatedly when opening.	H94	Repeated electronic obstacle recognition on closing by stationary obstacle.	Remove the obstruction.
Search run notified.	H61 H62	Search run of the door after a reset or after power recovery.	Allow the search run to travel its full course.
Door operates at a reduced speed.	H71	Battery operation	Wait for power recovery Switch on mains supply.
Normal door operation	H73	Motor overloaded in closed position	Have the system checked by a specialist
Door remains closed.	–	Operating mode such as OFF, EXIT or P.	E.g. select operating mode AUTOMATIC 1.
Door remains open.	–	Operating mode such as OPEN or P.	E.g. select operating mode AUTOMATIC 1.
Door remains open.	–	Sensor is activated repeatedly. LED on sensor lights up.	Remove moving objects from the sensor detection area.
Door does not lock in FRW OFF.	E11	Lock unit is jammed or defective.	In operating mode OFF when the door is closed: Push the door leaves against the closed position for a few seconds. Have the system repaired by a specialist.
Door does not open via the key switch while in FRW OFF. Lock unit produces switching noises.	E11	Lock unit is jammed or defective.	Turn on the key switch and then briefly push the door leaves against the closed position. Have the system repaired by a specialist.

System Behaviour	No.	Cause	Remedy/ Rectification
Dependent on configuration.	E2 ...	Error in bus system	Have the system repaired by an expert.
The door closes slowly.	E30 E34	The safety facility in the closing direction is permanently active (>1 min.) or defective.	Remove objects from within the range of the sensor(s). Otherwise have the system repaired by an expert.
Door remains closed.	E31 E37	The safety facility in the opening direction is permanently active (>1 min.) or defective.	Remove objects from within the range of the sensor(s). Otherwise have the system repaired by an expert.
The door opens slowly.	E32 E38	The safety facility in the opening direction is permanently active (> 1 minute) or defective.	Remove objects from within the range of the sensor(s). Otherwise have the system repaired by an expert.
The door remains open.	E33 E39	The safety facility in the closing direction is permanently active (> 1 minute) or defective.	Remove objects from within the range of the sensor(s). Otherwise have the system repaired by an expert.
The door remains open.	E41 E42	Activator inside is active > 1 min. Activator outside is active > 1 min.	Get sensor adjusted by an expert.
The door remains open.	E43	Key switch is active > 1 min.	Reset the key switch.
The door remains open.	E46	Emergency opening monitoring > 10 min. active	Reset emergency opening command
The door remains open.	E48	Key switch to wake-up battery >1 min. active	Reset the key switch.
The door stands still.	E51	Encoder defective.	Have the system repaired by an expert.
The door stands still.	E53 E54 E55	Anomaly in the travel distance. Solid obstruction in the movement area.	Remove firm obstacle in the travelling range of the door. Perform a software-reset. Have the system repaired by an expert.
The door remains open.	E61 E62 E63	Power supply is overloaded or voltage too low.	Get the power supply and connections checked by an expert.
The door remains open.	E64 E65	Drive/control system is overheated.	Wait for the automatic reset after the door/control system has cooled. Protect from direct sunlight.
The door stands still.	E66	Motor control defective.	Have the system repaired by an expert.
Normal operation	E67	Drive heavily loaded.	Wait for the automatic reset Otherwise have the system repaired by an expert.
Door remains open	E71 E74	Opening movement takes too long	Remove any obstruction in the direction of opening. Have the system checked by a specialist.
Door remains open or in normal operation.	E72	Battery charge < 15 %	Wait until the battery is sufficiently charged.

System Behaviour	No.	Cause	Remedy/ Rectification
The door remains open.	E73	Internal function test, battery unit/escape route unit shows negative	Do a software reset or switch FRW OFF/ON. Otherwise have the system repaired by a specialist.
The door remains open.	E70 E75	End-switch error	Have the system repaired by a specialist.
The door remains open.	E76	Holding brake is defective	Do a software reset or switch FRW OFF/ON. Otherwise have the system repaired by a specialist.
The door remains open.	E77	FRW spring return key switch is switched on > 1 minute.	Reset FRW spring return key switch. Otherwise have the system repaired by a specialist.
The door remains open.	E78	DCON relay test shows negative or DCON is missing.	Have the system repaired by a specialist.
The door stands still.	E8 ...	Control system shut down for safety reasons.	Perform a software-reset. Have the system repaired by an expert.
The door collides with people.	–	Safety device or setting inadequate.	Shut down the system. (see chapter 2.7).

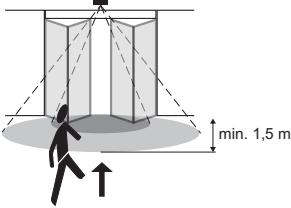
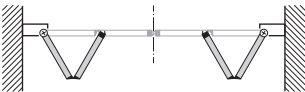
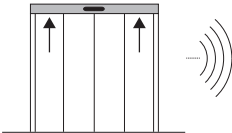
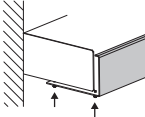
8.2 Check-list for Functional Checks

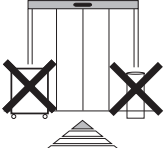
Item To Be Checked	Procedure	Result
Sensors		
	<ul style="list-style-type: none"> • Walk through the door directly from the front and from different directions at normal speed, starting both from the inside and outside. Activation (sensor field) at least 1.5 m before the main closing edge. • Walk through the door directly from the front and from different directions at a slow speed like an infirm person, starting both from the inside and outside. Activation (sensor field) at least 1.5 m before the main closing edge. 	<p>The door opens at the right time and with sufficient speed so that passage through the door is not hindered.</p> <p>The door opens and remains open until you are completely through the door.</p>
Door Leaves		
	<ul style="list-style-type: none"> • Check the glass door fillings, door edges and rubber profiles for damage. 	<p>The door fillings have no sharp edges and splintered glass.</p> <p>The side parts and the door seals are in place and undamaged.</p>
Guide System and Door Guides		
	<ul style="list-style-type: none"> • Check the noises made while the door moves. 	<p>No unusual and noticeable movement noises can be heard in the drive, guide system or floor guides.</p>
Cladding		
	<ul style="list-style-type: none"> • Check whether the cladding is correctly slotted into place. 	<p>The cladding is firmly slotted into place.</p>
Operating Controls		
	<ul style="list-style-type: none"> • Check the function and marking of operating controls. 	<p>The operating controls are functioning correctly; the markings are visible and legible.</p>
System Vicinity		
	<ul style="list-style-type: none"> • Check access to the door and the movement area of the door leaves. 	<p>Access to the door is free from objects and items likely to cause the user to trip. There are no objects such as shelves, plant containers and umbrella stands within a radius of 50 cm of the movement area.</p>



EC Declaration of Conformity

The manufacturer (installation company) of the complete door system declares

Manufacturer's address: _____

that the product (door system)

Type designation: _____

Serial number: _____

is in conformity with the directive 2006/42/EC (Machinery Directive)

is in conformity with regulations of the guidelines:

- 2014/35/EU (low tension)
- 2014/30/EU (electro-magnetic-compatibility)

and the following harmonised standards have been adhered to:

- EN 16005

Base document:

- Declaration of incorporation by TORMAX I LANDERT Group AG
- Risk evaluation for automatic folding doors I T-1917

Person responsible for documents

Name/address: _____

Place, date: _____

Signatory

(CE authorized person): _____

Signature: _____



the passion to drive doors

TORMAX Swing Door Drives

TORMAX Sliding Door Drives

TORMAX Folding Door Drives

TORMAX Revolving Door Drives

Manufacturer

TORMAX
Unterweg 14
CH-8180 Bülach-Zürich
Phone +41 58 500 5000
Fax +41 58 500 5099
www.tormax.com
info@tormax.com

Installation company (installation repairs, service)

TORMAX is a Division and a registered trademark of LANDERT Group AG