

Uniclass L7535	EPIC L13
CI/SfB (57)	X



SE
CONTROLS
secontrols.com



SE Controls is the leading specialist provider of Smoke Ventilation Solutions, offering the complete turn key solution to create an innovative and comprehensive life safety ventilation system.

SE Controls has over 25 years experience of working with clients through every step of the construction process, delivering designed, installed and maintained smoke and heat exhaust ventilation systems (SHEVS) to literally thousands of buildings. SE Controls' award winning track record gives clients the confidence to involve their design teams at concept stage in order to optimise the economic efficiency of design without compromising performance.

SE Controls has long recognised that the key to delivering successful projects is down to the skill of its people, and this approach and the knowledge base available enables clients to be supported in every aspect of their projects. Furthermore, clients can rely on a single point of contact from the start of the project through to its successful conclusion. The nature of SE Controls' systems means that different trades may be involved during the build period and systems may need interfacing with teams of glazing and façade contractors, electrical contractors as well as the main contractor. These are all managed by SE Controls' Project Teams.

The effects of smoke being generated by fire can reduce the visibility for the occupants and can increase the time to escape the fire, creating greater exposure to smoke inhalation that can consequently cause loss of consciousness.

SE Controls offers a comprehensive range of natural and powered smoke ventilation systems suitable for virtually any size and type of building. The systems are designed to create a smoke free layer above the floor by removing smoke from the building. This is achieved by using the natural buoyancy of the hot gases to rise and exhaust through automatic opening vents. This significantly improves the condition for safe escape by occupants and permits the fire to be fought in its early stages.

Fire costs money. In 2004 the costs as a consequence of fire, including property damage, human casualties and lost business, was estimated at £2.5 billion.

Building owners, designers, developers and stakeholders share a responsibility to reduce the risk of fire. If a fire does occur the occupants must be protected. The installation of a smoke and heat control system can limit the potentially tragic effects of a fire by significantly increasing the conditions for safe escape and by permitting the fire to be fought in its early stages.

SMOKE KILLS!

In 2005, 35,300 fires were recorded in the United Kingdom in non-domestic buildings with 165 fatalities in England and Wales by the means of the toxic effect of carbon monoxide and other gases, fumes and vapours.

(Office for National Statistics)

Principles of Smoke Ventilation



Smoke ventilation allows the creation of a smoke free layer above the floor by removing smoke. This improves the conditions for safe escape and permits the fire to be fought in its early stages.

What happens if there is no means of smoke ventilation?

1. In an unventilated room, smoke will rise directly to the ceiling.
2. The smoke will begin to fill the space available moving laterally instead of vertically.
3. Convection of the smoke will cause it to be drawn back down to low level reducing visibility and the chances of a safe escape.
4. Temperatures will continue to rise causing the potential flash over and collapse of the building.

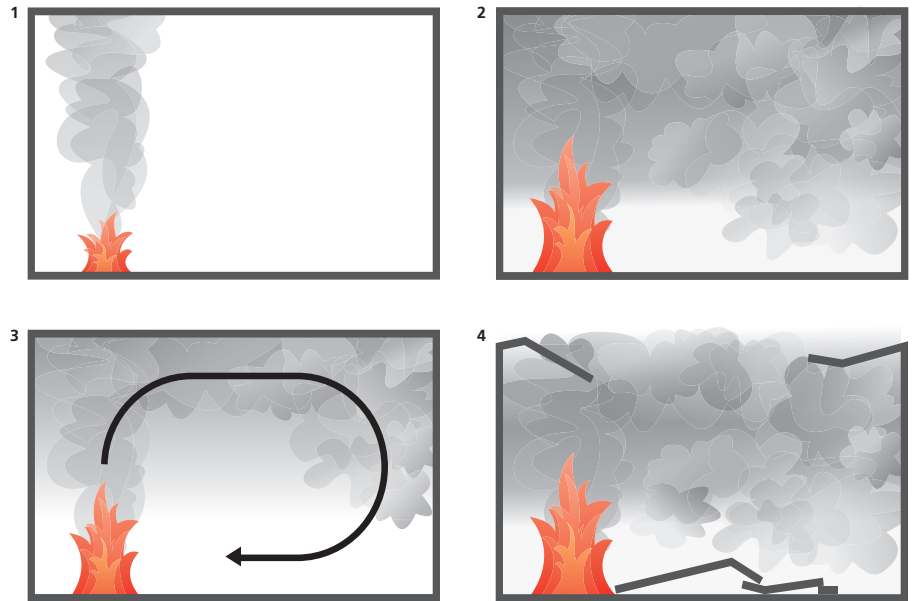

What happens if there is a smoke ventilation system?

1. In the event of a fire, actuators open high level smoke vents and low level fresh air inlet vents.
2. This allows cool air into the building, forcing the hot air and smoke out via the roof, providing a smoke free layer for safe escape.
3. The smoke free layer allows safe access for the fire to be fought and extinguished.

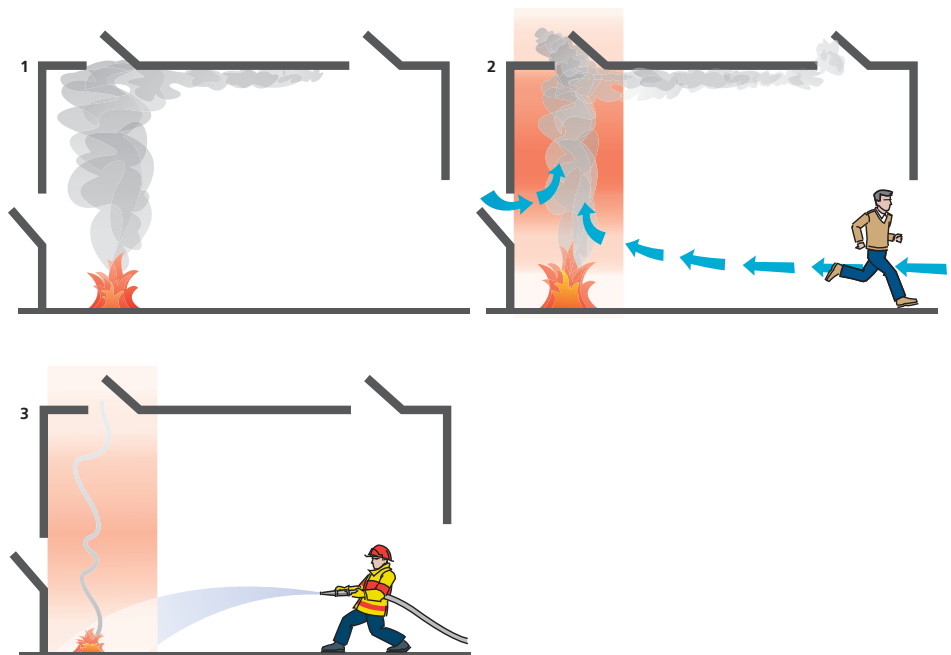

Core Competencies – The Total Solution

Design and Consultation

The design of smoke and heat exhaust ventilation systems (SHEVs) falls into two distinct areas, namely those systems complying with building regulations and those systems requiring a fire engineered solution. SE Controls is able to offer both.

Code Compliant Designs

SE Controls are able to offer initial consultation and advice on schemes proposing to follow the prescriptive approach laid down in Approved Document B. Extensive involvement in government sponsored working groups has provided SE Controls with a unique insight into the methodology behind Approved Document B and SE Controls are able to share this knowledge with SE Controls' clients. Furthermore any products proposed will be guaranteed to perform to the design intentions set out in Approved Document B.

Fire Engineered Solutions

It is not always possible to apply a code compliant or prescriptive solution to every scheme. When this occurs, Approved Document B (ADB) allows the designer to step away from ADB and provide a Fire Engineered Solution. As a Fire Engineered Solution will be dealing with many unknown factors, it needs to prove that any system must perform at least as well as an ADB prescribed solution. In order to do this SE Controls will typically model various scenarios using Computational Fluid Dynamic (CFD) analysis. These results would typically be presented in a report which would be suitable for submitting to Building Control. Part of SE Controls' design service would be to take the design through the approval process on behalf of SE Controls' client bringing all of SE Controls' specialist knowledge to the project methodology to provide the optimum solution.

There are significant advantages in involving SE Controls as early as possible in the design process. CFD modelling allows SE Controls engineers to analyse various types of systems to achieve the optimum outcome for the client. It is quite feasible for CFD modelling to indicate that a code compliant system is actually the optimum system for the client to install. Alternatively SE Controls are able to propose systems which may provide significant economic advantages for the client. This may be via value engineering the SHEVs, minimising the impact of the SHEVs on the usable floor space typically through reduced size smoke shafts using powered extract rather than natural systems. Alternatively it may be advantageous to increase the maximum travel distances allowable under Approved Document B by designing systems that not only match ADB performance but actually perform to a higher standard.

Supply

SE Controls offer a wide range of leading edge smoke heat exhaust ventilation systems (SHEVS) that are designed and tailored to facilitate the client's requirements and ventilation strategies to meet the structure of the building.

There are a number of different solutions available including natural ventilation and powered smoke ventilation. SE Controls are focused on delivering innovative solutions designed around the building envelop and clients requirement. SE Controls are committed in providing new solutions and technologies by reinvesting profits to provide the client with greater benefits and solutions to a controlled budget.

All of SE Controls products are CE Certified and comply with the latest British and European legislation.

Installation

Whether the project installation is a new project or an existing install, SE Controls experienced and fully trained team of engineers are on hand to work in accordance with the building schedule to deliver the project on time and to schedule.

Understanding what the customer expects and the construction process including the coordination with third parties provides a smooth project delivery.

Commissioning

As the smoke ventilation system plays a crucial part of the life saving strategy, it is fundamental that the system is commissioned, demonstrated and certified to the design methodology. SE Controls qualified engineers fully inspect each system before despatch and installation ensuring that the system meets the design profile before hand over to the client.

Maintenance

The maintenance of any fire safety equipment plays a vital part in ensuring that the installed system operates correctly in the result of emergency and that the system can operate in its planned operation. The smoke ventilation system plays a fundamental role in creating a healthier and safer environment for internal occupants.

SE Controls continual investment in the latest cutting edge technology allows their products to be optimised to maximise the performance of the implemented systems. These improvements can deliver increased efficiency, safety and functionality of their customers' ventilation strategies and are maintained in accordance with the Regulatory Reform Order (RRO) and The Building Regulations Approved Document B.



Design and Cost Planning

At early design stages SE Controls can assist the client and design team in specifying the most cost efficient, practical and compliant solution for smoke ventilation. A detailed design can be produced which allows plans to be submitted for approval. This solution can be within the guidelines of approved document B or a bespoke fire designed solution.

Decision making process of the design procedure:

- Natural or powered systems
- Escape/fire fighting stair positions
- Escape distances
- Smoke shaft size and positions
- Smoke shaft AOV products
- AOV window positions
- Fire doors
- Louvre &/or roof light
- Cable specifications
- AOV roof vent types.

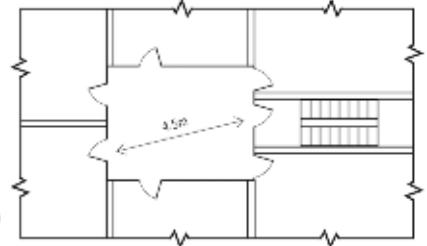
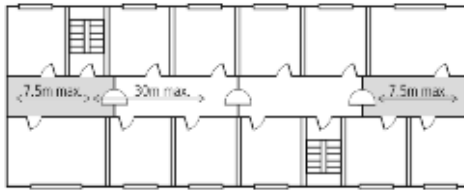
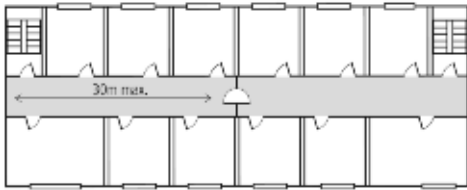
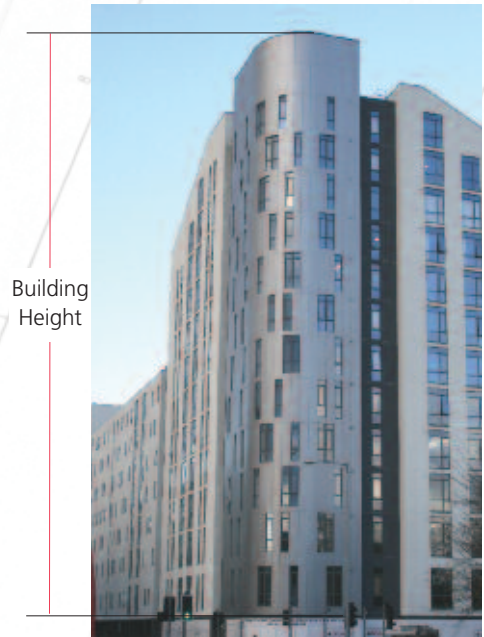

Typical product solutions

Escape Stair



End of Wall Corridor AOVs



Mechanical Smoke Shaft



Natural Smoke Shaft

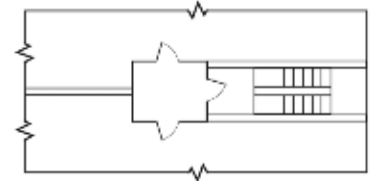

Typical Building Footprint

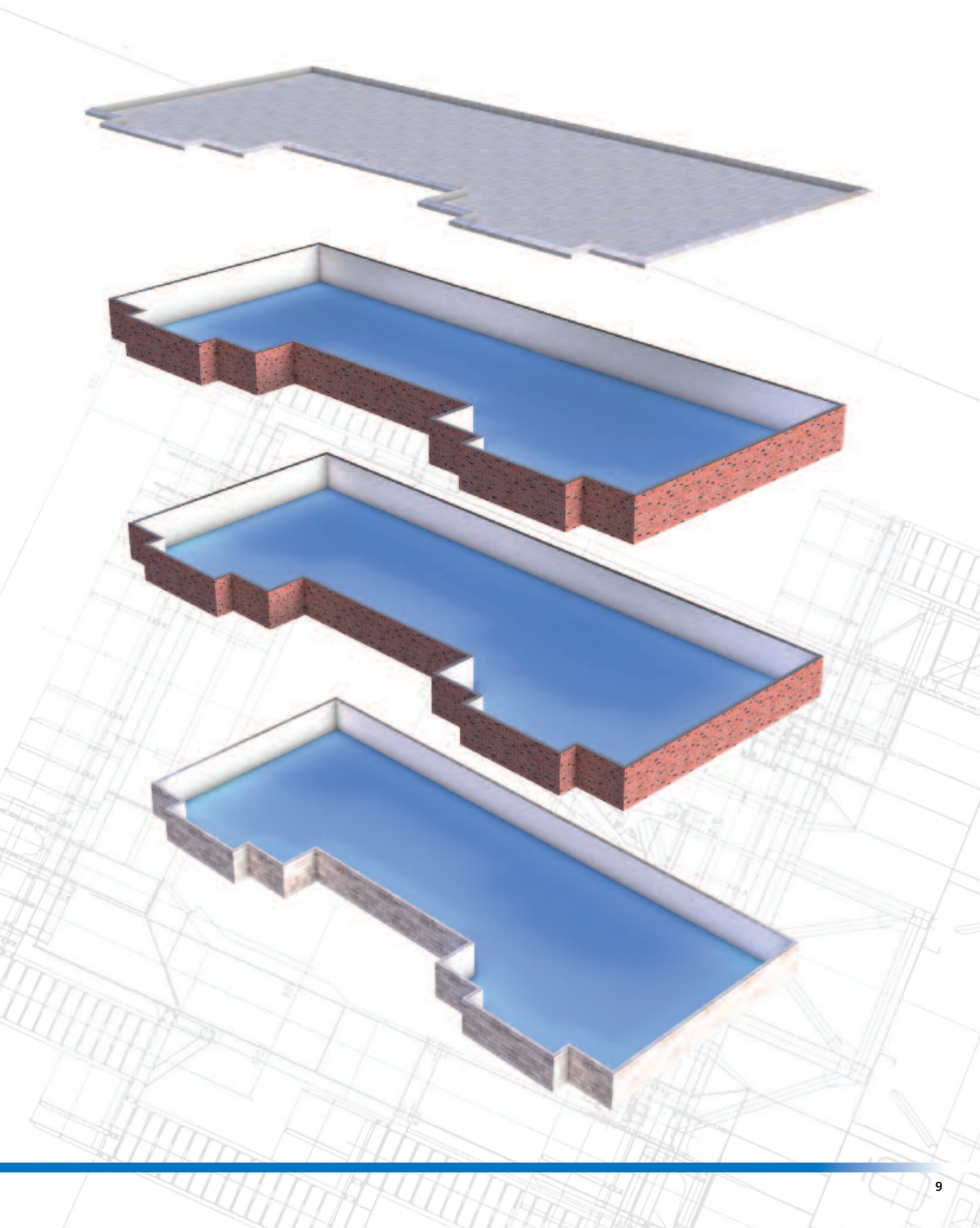



Approval and Tendering Process

SE Controls offers coordination with the client, the approving body and bidding contractors throughout the tendering process.

Considerations:

- Coordination with approving body
- Production of specification quotations for tendering
- Planning and mid tender meetings

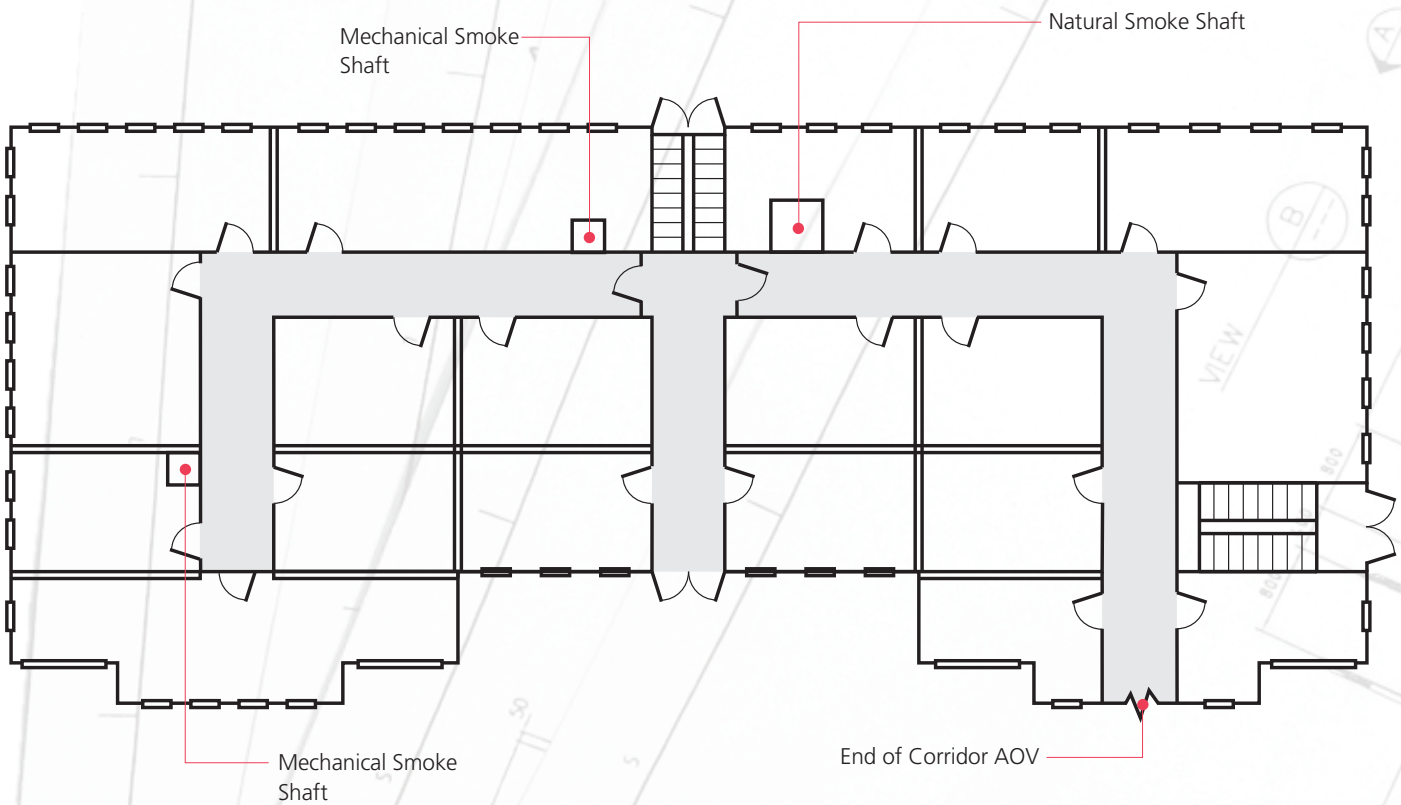

Floor Layouts

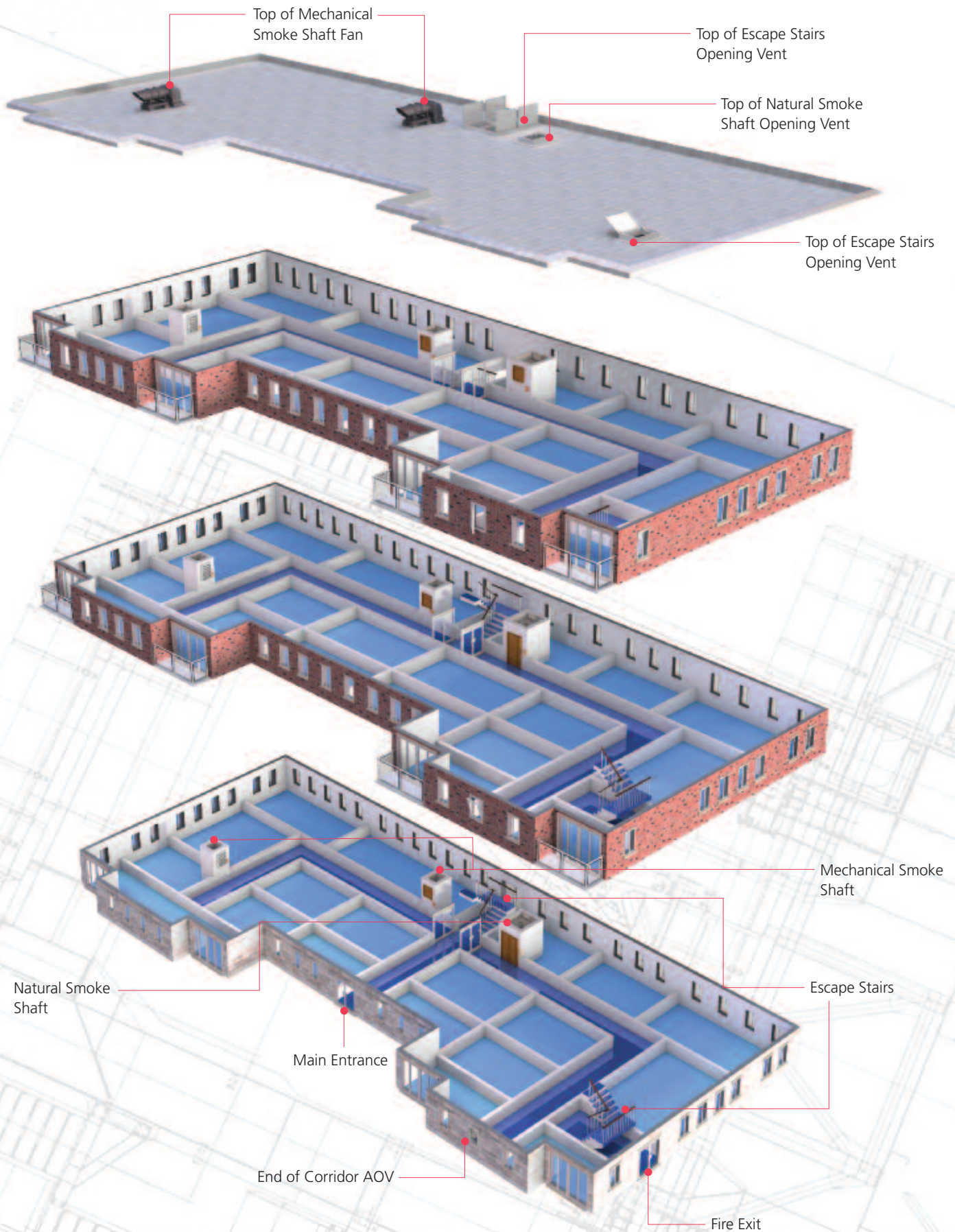



Stage 1 Coordination

Stage 1 Coordination

At early stages of the project vital information is required by the contractor. AOV openings are built into the shell and the core of the building to various elements including, walls, roofs and cores. This is particularly important for smoke shafts and cores that may be pre cast or built off site.

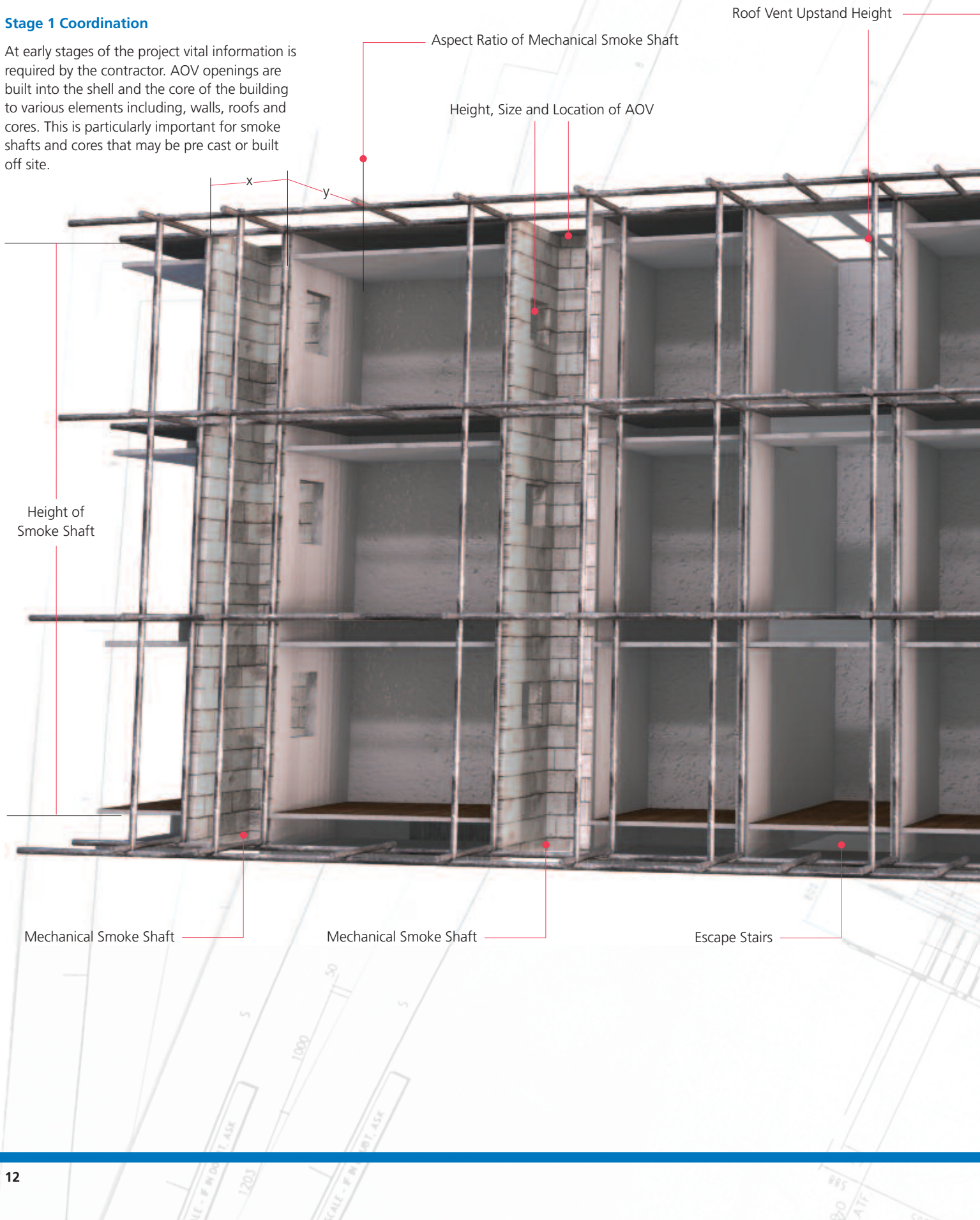

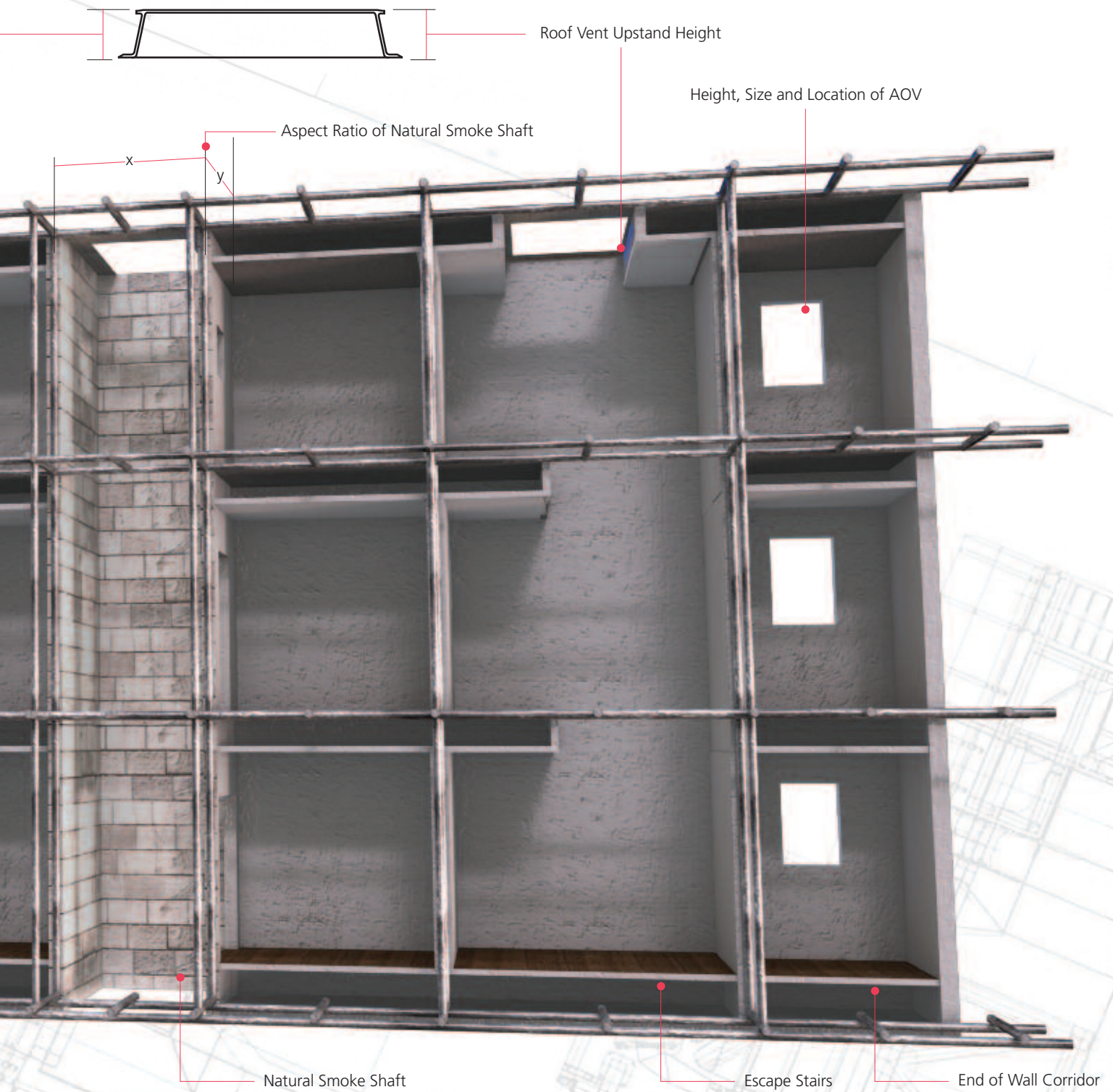

Roof Vent Upstand Height

Height, Size and Location of AOV

Aspect Ratio of Natural Smoke Shaft

x

y

Natural Smoke Shaft

Escape Stairs

End of Wall Corridor



1st Fix Cabling

1st Fix Cabling

The smoke ventilation system must be fully designed and approved prior to the installation of the 1st fix cabling. Full wiring schematics are produced for cable installation with all devices located and detailed. This work can be carried out by SE Controls or the contractor who is already on site.

OS2 Control System

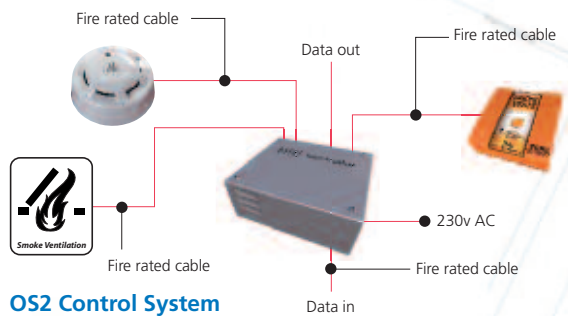
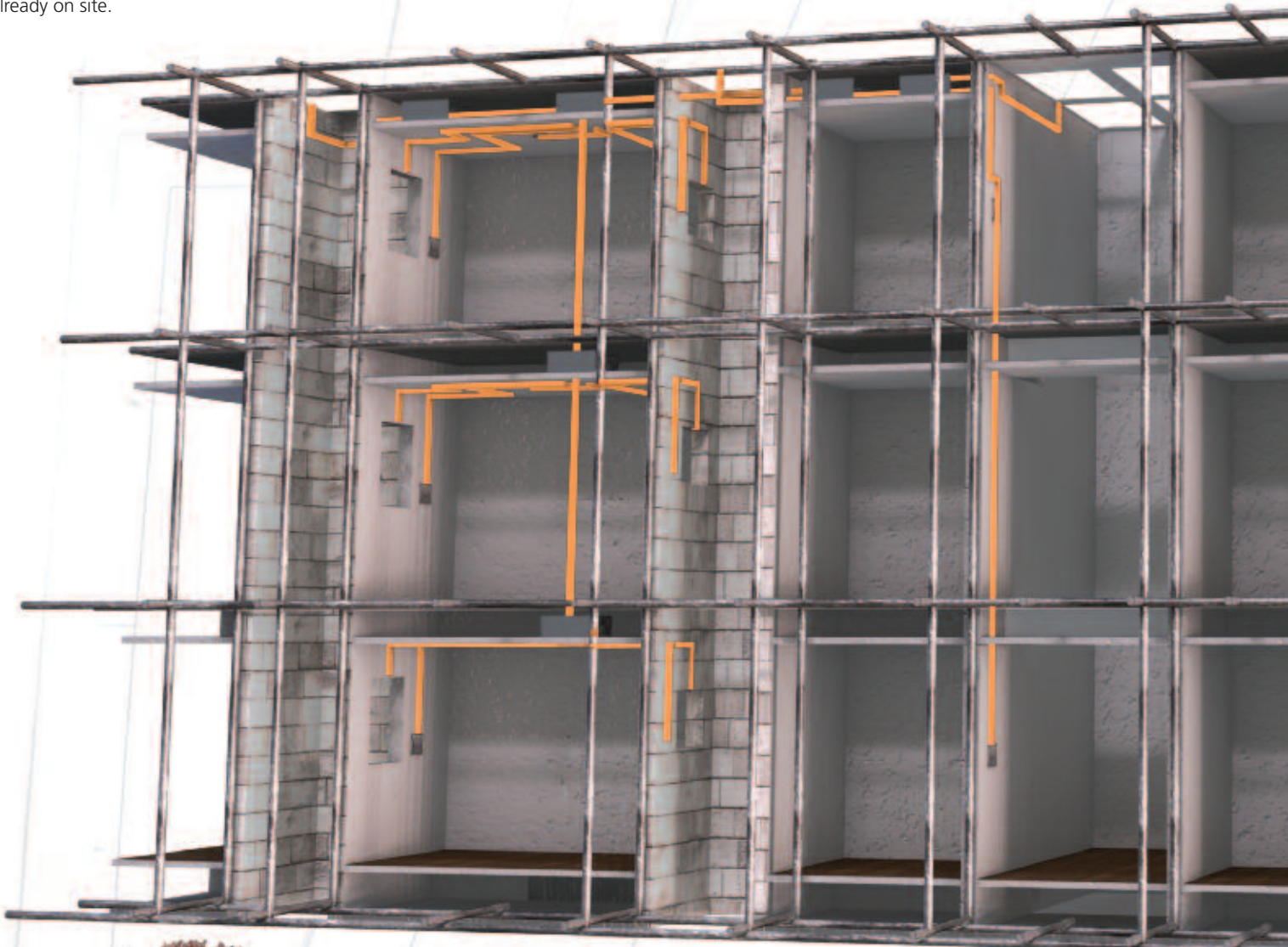

**OS2 Control System
Graphical Key**



Product Installation

Product Installation

At suitable stages after 1st fix cabling the associated smoke vent products are installed and connected. SE Controls smoke ventilation products are suitably certified and compliant to British and European legislation.

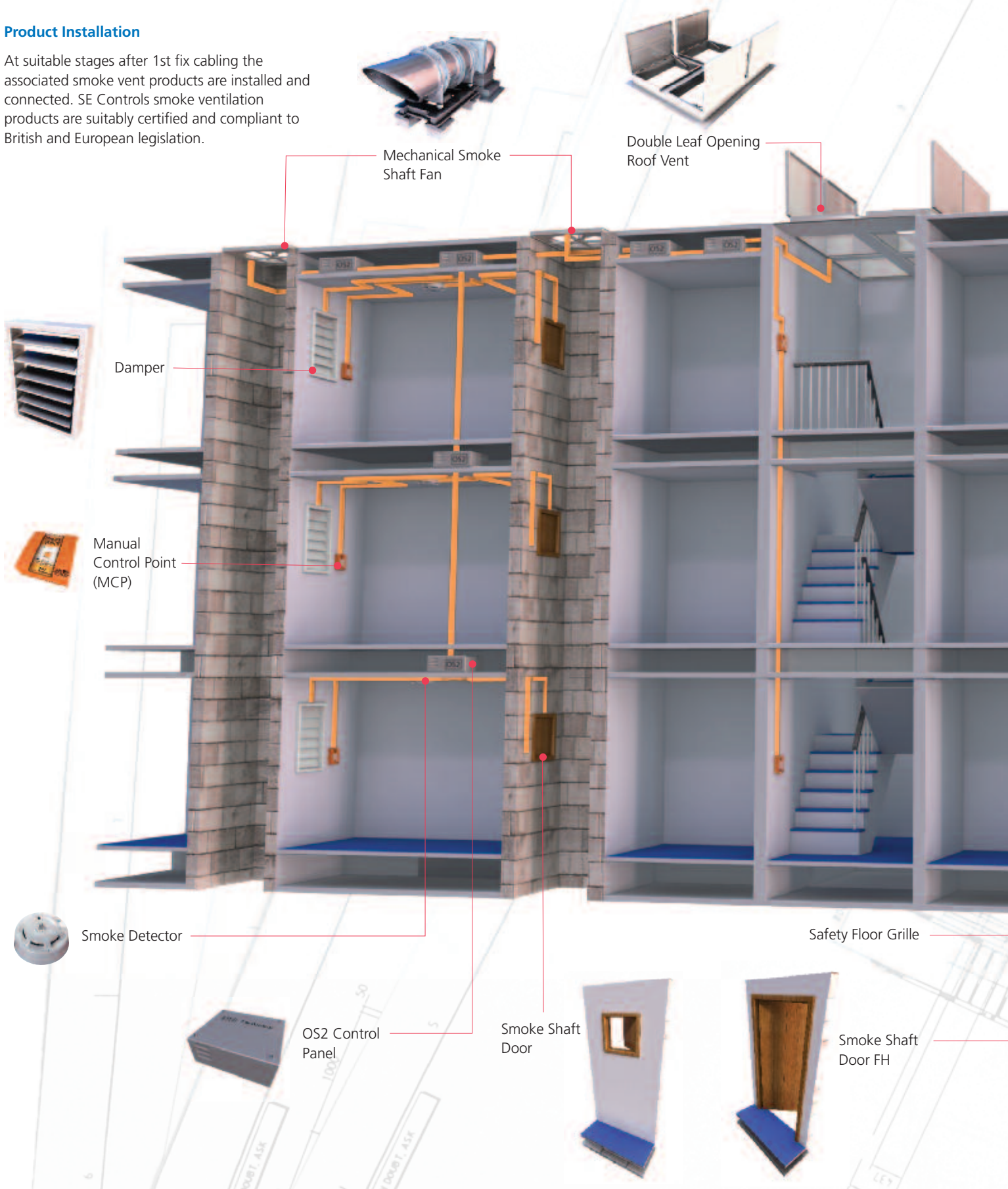

Smoke Detector



OS2 Control Panel



Smoke Shaft Door



Smoke Shaft Door FH

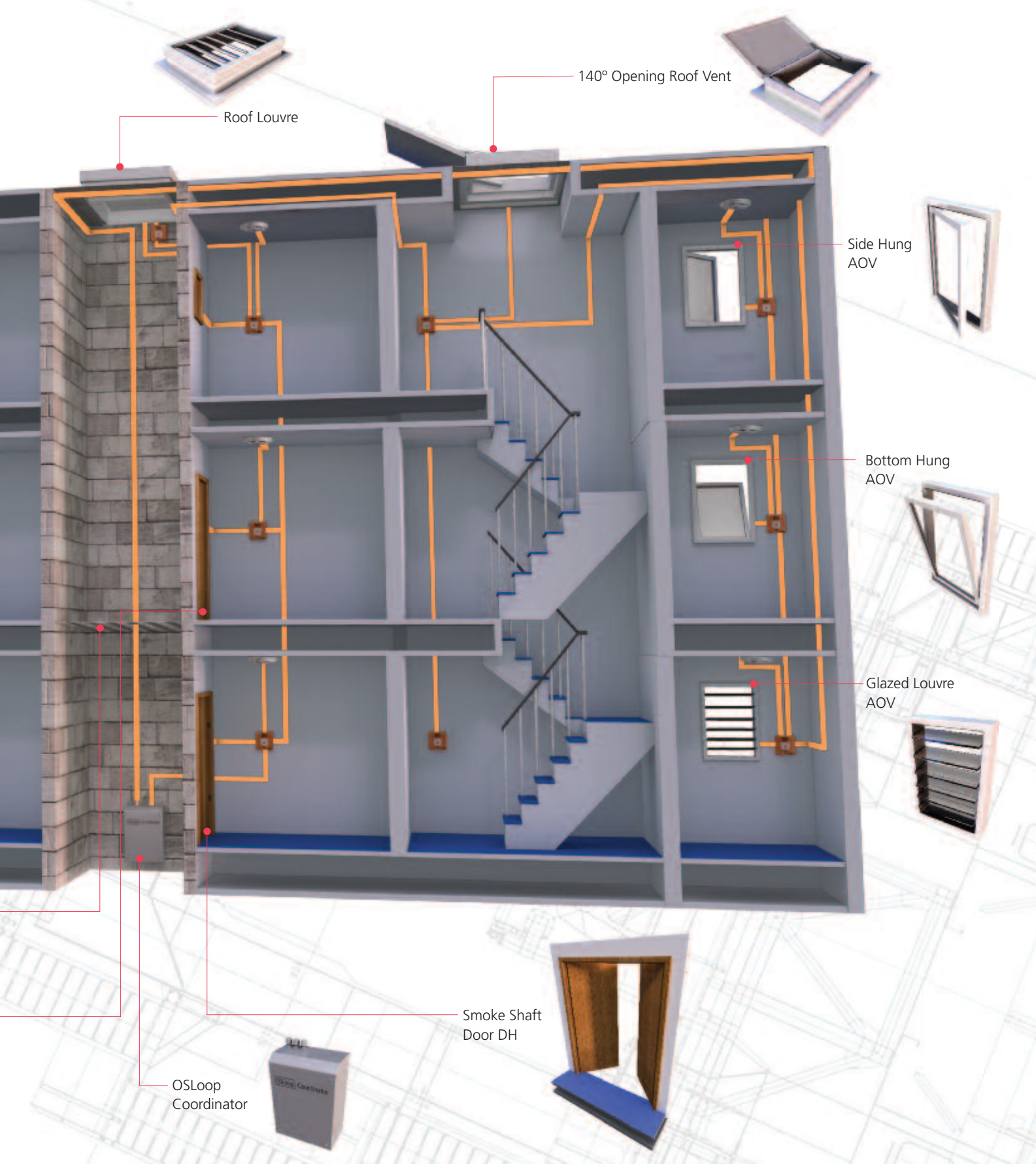



Commissioning and Handover

Commissioning and Handover

When permanent mains power is available the SHEV system is commissioned, certified and handed over. At this point the client can be satisfied that a certified, fit for purpose and compliant smoke ventilation system is installed within their building.

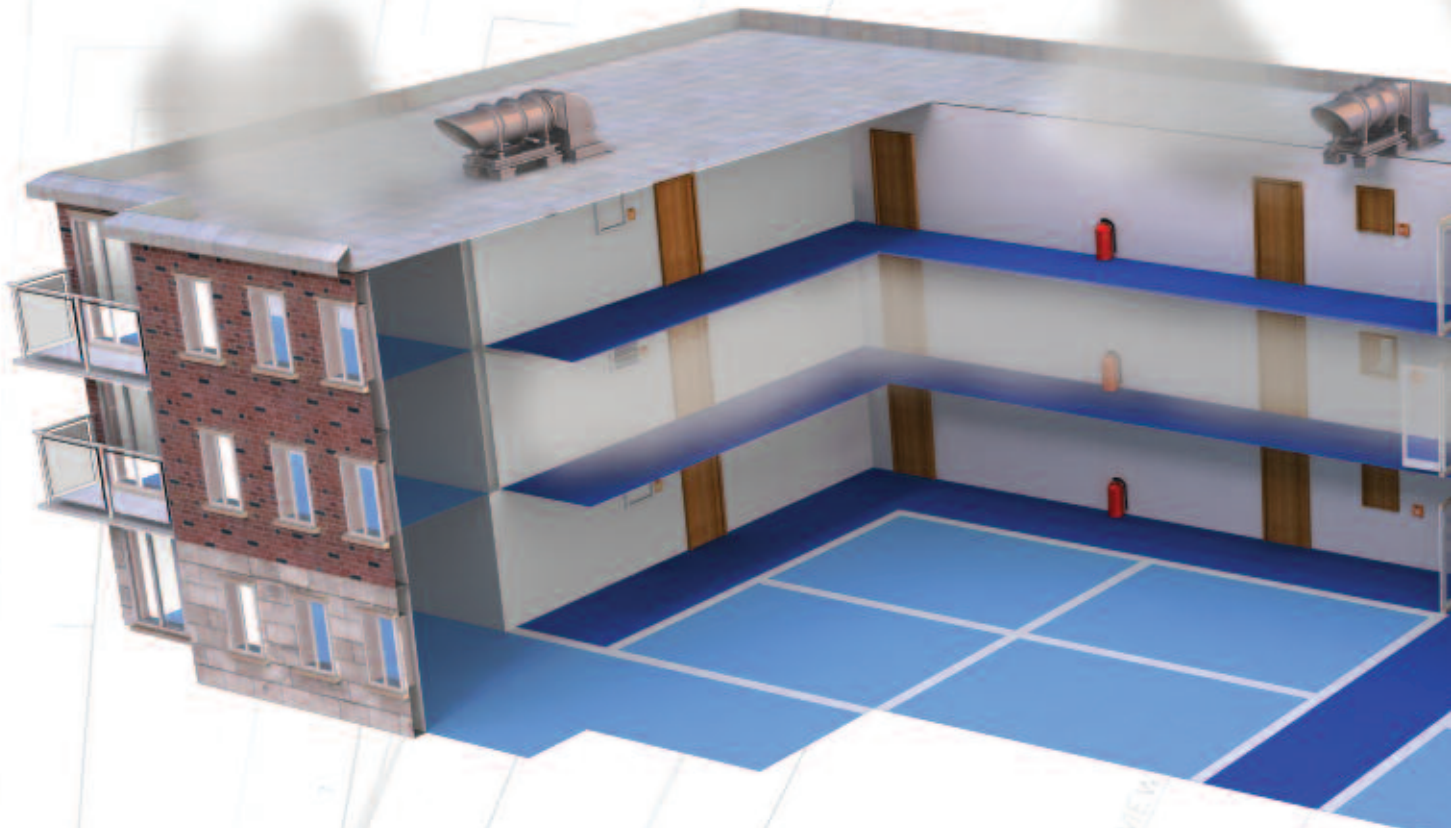

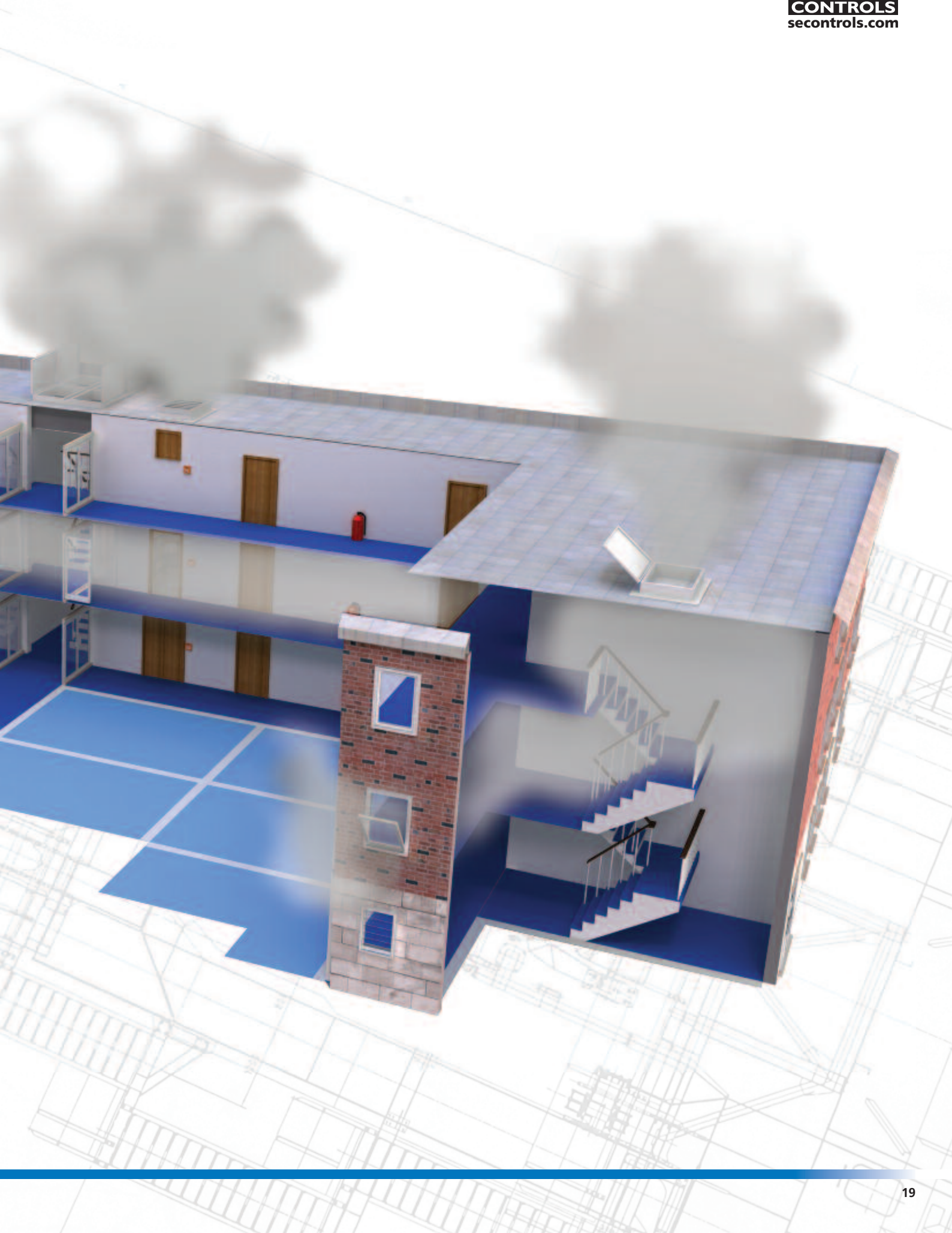



Maintenance – Nationwide

Maintenance

SE Controls provides ongoing maintenance to ensure that the smoke ventilation system continues to operate as designed to provide a life safety system. The building owner is required to maintain the system in accordance with the Regulatory Reform Order (RRO) and The Buildings Regulations, Approved Document B.





TOP: London School of Economics
LONDON

ABOVE: Liverpool South Parkway
LIVERPOOL

RIGHT: Plymouth Grove
MANCHESTER

Reference Sites



ABOVE: Fusion Building
WOLVERHAMPTON

RIGHT: Left Bank
MANCHESTER

FAR RIGHT: Skyline Central
MANCHESTER

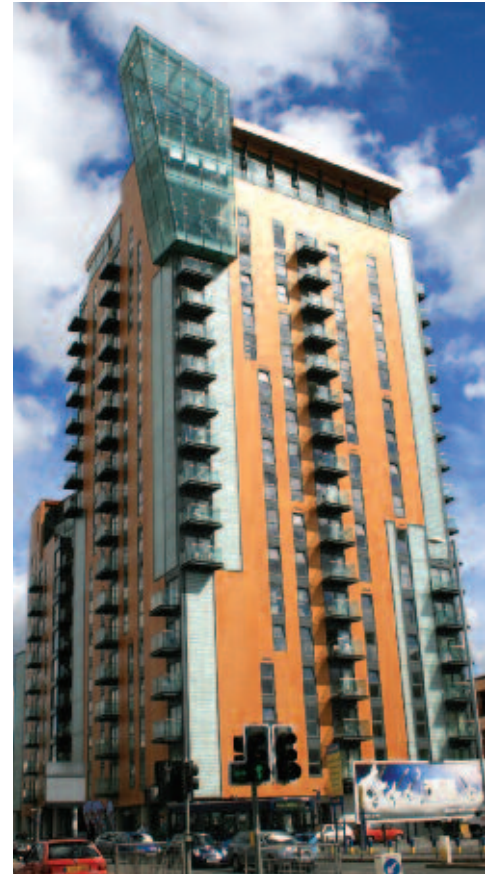



TOP: Battersea Reach
LONDON

FAR LEFT: Navigation Street
BIRMINGHAM

LEFT: The Green Building
MANCHESTER

Product Selector – Escape Stairs



Manual Control Point (MCP)



OS2 Control Panel

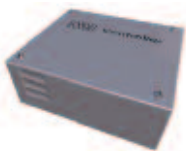

OSLoop Coordinator



Roof Louvre

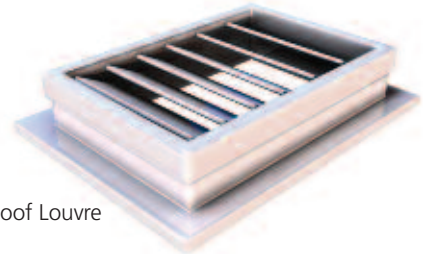

Double Leaf Opening Roof Vent



140° Opening Roof Vent

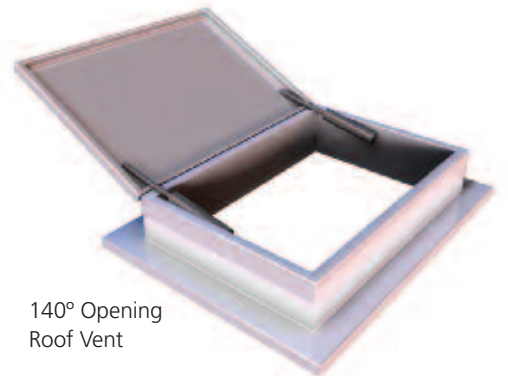

Bottom Hung AOV





Product Selector – End of Wall Corridor AOVs



Manual Control Point (MCP)



Smoke Detector



OS2 Control Panel

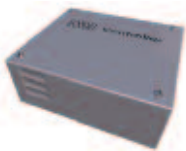

OSLoop Coordinator



Side Hung AOV



Bottom Hung AOV



Glazed Louvre AOV



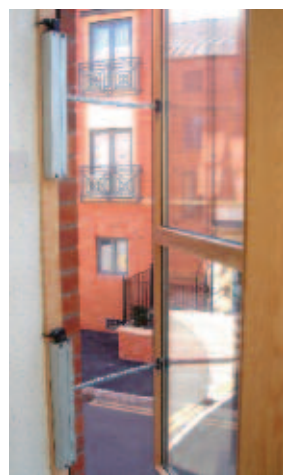

Product Selector – Mechanical Smoke Shaft



Product Selector – Natural Smoke Shaft

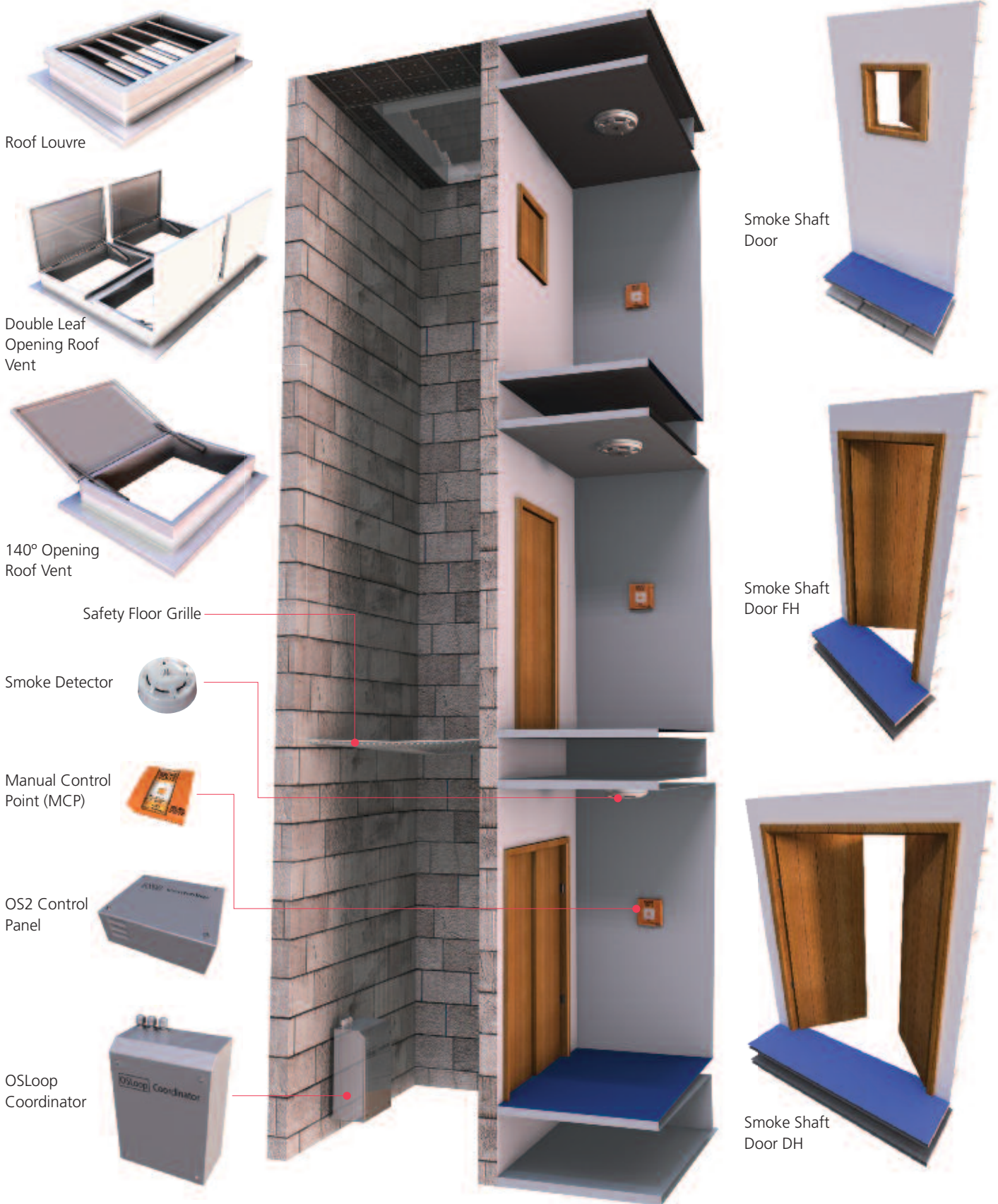

Reference Sites





TOP: Salford Quays
MANCHESTER

FAR LEFT: The Island, Brentford Lock
MIDDLESEX

LEFT: West End Quay
LONDON

SHEVTEC

secontrols.com

The following pages provide product specifications and uses of a range of smoke ventilation solutions available from SE Controls.

Product Specifications – Automatic Opening Vents (AOVs)

Depending on the structure of the building envelope SE Controls can provide an adaptive solution to meet the design methodology and ventilation strategy. With an extensive product range for any combination of AOVs, SE Controls provide EN12101-2 certified products to create a comprehensive solution.



Selection Considerations



Side Hung AOV



Bottom Hung AOV



SHEVTEC Glazed Louvre AOV



SHEVTEC Smoke Shaft Door and Actuator

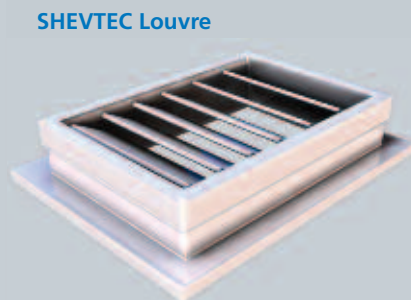

SHEVTEC Louvre

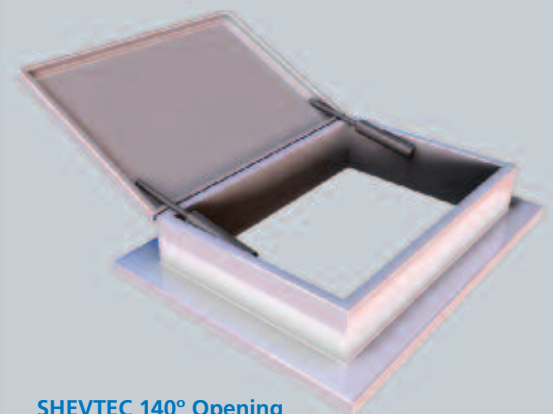

SHEVTEC 140° Opening Roof Vent



SHEVTEC Damper



SHEVTEC Double Leaf Opening Roof Vent

Product Specifications – SHEVTEC Smoke Shaft Door and Actuator

SHEVTEC Smoke Shaft Door Actuator

SE Controls SHEVTEC smoke shaft door actuator is a ventilation solution that can be used in a natural or mechanical shaft as an alternative to dampers within a commercial or residential application.

Tested to EN12101-2, the SHEVTEC smoke shaft door actuator offers the construction industry a fully certified fit for purpose AOV door operator. The actuator can be retro fitted to an existing smoke shaft door to either side and can be removed for maintenance via security tooling. To meet the stringent requirements of opening and closing a sealed smoke door, the actuator has been rigorously cycle tested for reliability and operation at 300°C in accordance to EN12101-2. The actuator is power open, power close to maintain shaft integrity for the unaffected floors when subjected to high temperatures within the shaft.



SHEVTEC Smoke Shaft Floor Grilles

Should the shaft require floor grilles SE Controls can install this item complete with structural calculations for its application.

Safety grilles are provided to facilitate maintenance access within the smoke shaft. Also where the AOV is located below 1100mm from FFL, the inclusion of a safety floor grille will alleviate the need for additional fall protection.



SHEVTEC Smoke Shaft Door

A fully tested FD30 rated SHEVTEC smoke door is available for smoke shaft applications in accordance to EN12101-2. A range of finishes is available to suit each individual project requirement.

The SHEVTEC fire door is fitted with intumescent seals to ensure the fire rating of the shaft is maintained on unaffected floors. The door is fitted with a fully tested SHEVTEC smoke door actuator (shaft or corridor side) that can open the door against an expanded seal. Under the new ADB, 1m² is required for a natural shaft smoke door which allows installation above 1100mm from FFL if correctly coordinated. This negates the need to grille the shaft however SE Controls recommend egress should still be considered.



CE CERTIFIED

Compliant to applicable regulations.

Product Specifications – SHEVTEC Damper

SHEVTEC Damper

In the event of a fire the SHEVTEC damper powers open its blades on the corresponding floor of the fire in conjunction with the top of shaft roof vent to allow the flow of smoke to be ventilated into the smoke shaft and out of the building. All dampers on the remaining floors will remain closed to reduce smoke leakage and the risk of the fire spreading to additional floors.

A fully tested aluminium smoke SHEVTEC damper is available in 0.5, 1.0 & 1.5m² applications and can be powder coated or fitted with a decorative grille to provide a practical and aesthetic solution.

Features

- 1.5mm galvanised steel construction
- Motor open, motor closed or spring return operation
- Smooth parallel blade operation
- Low leakage rate
- High free area design
- Optional decorative fascia grilles.



CE CERTIFIED

Compliant to applicable regulations.

Product Specifications – SHEVTEC Roof Vents

SHEVTEC Double Leaf Opening Roof Vent

The SHEVTEC double leaf opening roof vent can be used in the head of the smoke shaft or escape stair to extract smoke from common corridors, escape stairs or lobbies. When activated the double leaf opening roof vent provides an acceptable solution, as detailed in EN12101-2, in reducing the risk of negative discharge due to wind pressure.

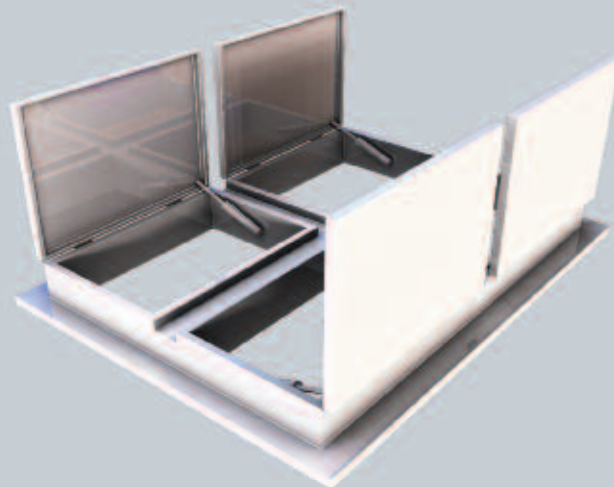

SHEVTEC 140° Opening Roof Vent

SE Controls SHEVTEC 140° opening roof vent can be used in the head of the smoke shaft or escape stair to extract smoke from common corridors, escape stairs or lobbies to ensure safe escape for the occupants and to create a smoke free area for access to fire fighters. EN12101-2 requires that a single leaf opening roof vent should open to at least 140° to reduce the chance of a negative discharge occurring due to wind pressure.

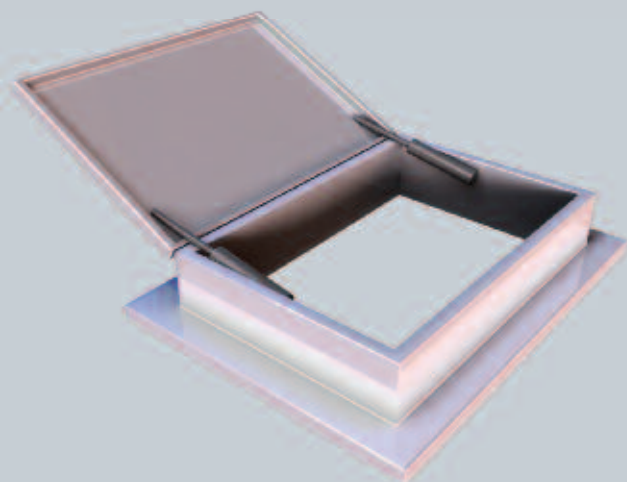

SHEVTEC Louvre

SE Controls SHEVTEC louvre is a fully tested and certified aluminium louvre for smoke clearance in the head of escape stairs or smoke shaft to operate in conjunction with the effected floor. When in full operation the SHEVTEC louvre provides safe escape for the internal occupants by removing smoke from the affected area and creates access for fire fighters.

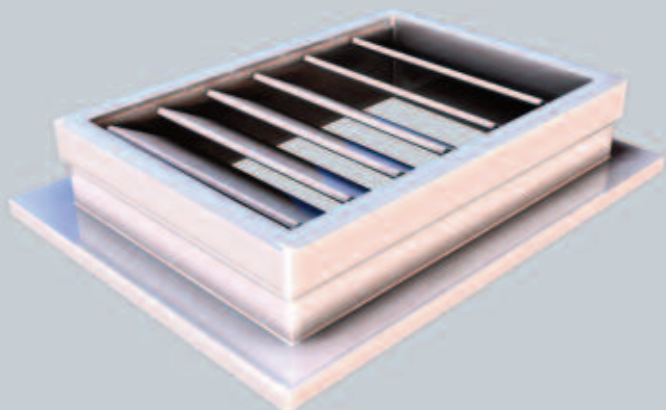

Features

- High efficiency – aerodynamically tested to EN12101-2
- Weatherproof – its resistance to air leakage and rainwater is tested to BS 5368 and BS 6375
- Reliability – life cycle tested to class RE1000 under EN12101-2
- Durability – tested to withstand wind loads of class WL1500 and snow loads of up to class SL500 under EN12101-2
- Installation – can be fitted into any roof or glazed construction.



CE CERTIFIED

Compliant to applicable regulations.

Product Specifications – SHEVTEC Glazed Louvre AOV

SHEVTEC Glazed Louvre AOV

SE Controls SHEVTEC glazed louvre AOV is produced with thermally-broken aluminium frames and tested to EN12101-2 smoke vent standards.

With a maximum opening angle of 90°, SHEVTEC glazed louvre AOVs provide a large free area of ventilation compared to standard window constructions.

SE Controls SHEVTEC glazed louvre AOVs can be anodised, powder coated in all standard RAL colours.

The double glazed unit thickness is available in either 24mm or 28mm.

Louvres can be incorporated into curtain wall frames that are available in mounting thicknesses of 24mm to 40mm.

The units are sealed with continuous EPDM profiles.

Finger trap protection is optional depending on louvre location (EN60335-2-103:2003).

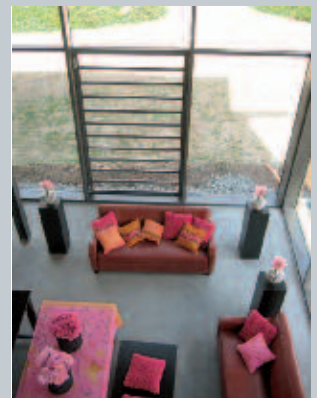

CE CERTIFIED

Compliant to applicable regulations.

Product specifications – OS2 Control Panel

OS2 Control Panel

The ultimate 24v DC motor operating control that fulfils the simplest stand alone system through to a fully networked intelligent SHEV system with BMS interface. Every OS2 controller operates on a mains voltage primary power supply and contains integral fully monitored and intelligent battery back-up for secondary power operation.



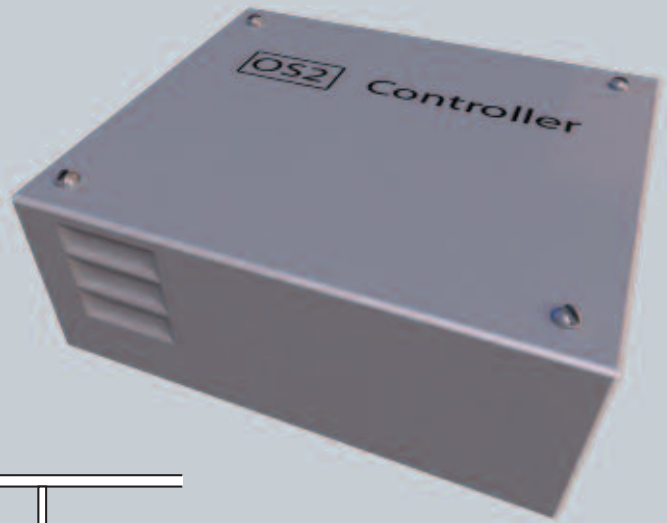

OS2 has been designed to be easy to install whilst providing robust and reliable control. OS2 control is compatible with OS2 MCPs and a host of peripheral control products.

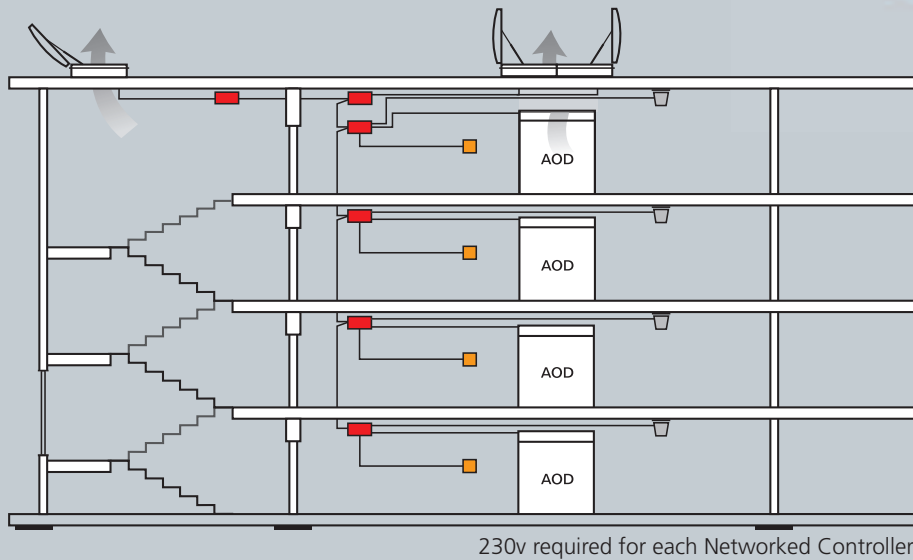

Networked Control System



Key

-  Central Control Point
-  Ionisation Smoke Detector
-  Networked Controller
-  Manual Control Point

Centralised Control System

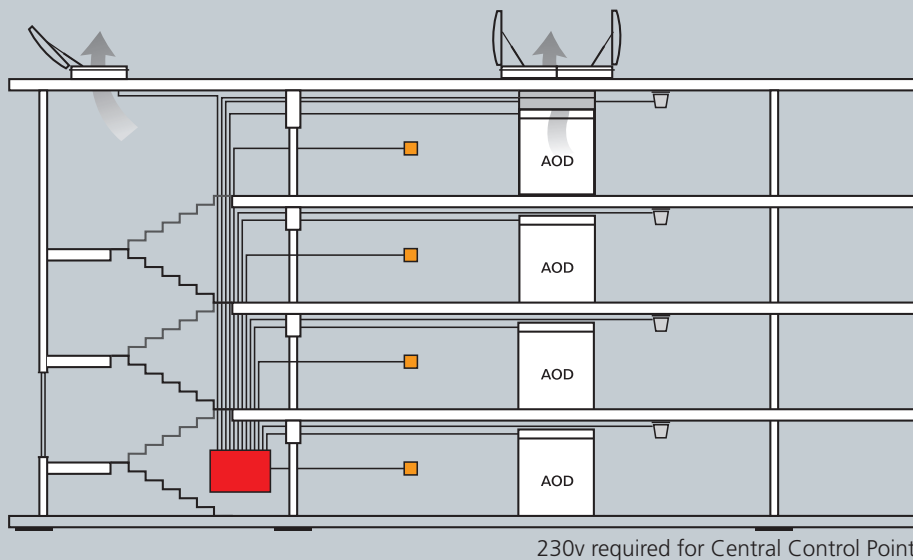

CE CERTIFIED

Compliant to applicable regulations.

Unit comes in a standard GREY Powder coated enclosure

Product specifications – OSLoop Coordinator

OSLoop Coordinator

OSLoop is a modular smoke control product. At its simplest, it consists of a centralised coordination module (the coordinator) and between 1 and 64 remotely mounted manual control points (MCPs). Larger systems can be constructed by linking together multiple coordinators.

The coordinator module contains the mains power conversion electronics which provides the 24V DC power for the operation of the unit. It also contains a back-up battery supply to support this supply if the mains power input is lost. To keep the size of the power supply and batteries to a minimum, the coordinator determines how and when the MCPs can call on this power to move their actuators.

Each MCP contains actuator switching circuitry which also monitors the actuator cabling and circuitry for faults. If a fault is detected, then the MCP raises a local alarm and also informs the coordinator so the remote alarms can be triggered. The MCP also provides support for one or more smoke detectors. Again this circuitry monitors the detectors and cabling checking for faults. In addition the MCP can be configured as master/slave device to other MCPs in the same system.

Features

- System power is delivered via the Manual Control Point reducing the power supply and cable requirements
- 40% less cable costs than a conventional system
- 50% less devices compared to conventional systems
- Reduced system installation time
- prEN12101-9 and prEN12101-10
- EMC tested to EN61000-6-2 and EN61000-6-3
- LVD tested to EN60335-1 as amended by EN60335-2-103.



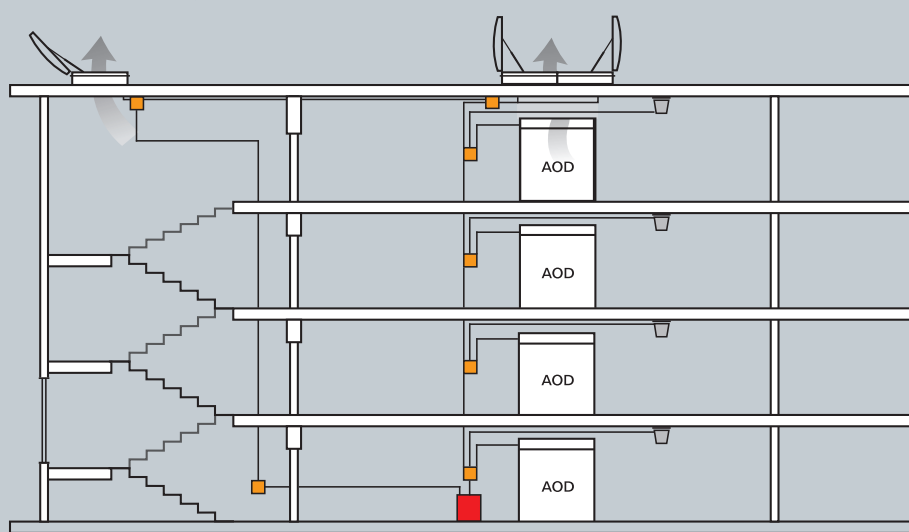

OSLoop Control System



230v required for OSLoop Coordinator

Key

-  OSLoop Coordinator
-  Ionisation Smoke Detector
-  Manual Control Point



CE CERTIFIED

Compliant to applicable regulations.

Unit comes in a standard GREY Powder coated enclosure

Product specifications – Manual Control Point (MCP), Smoke Detector & Repeater Panel

Manual Control Point (MCP)

The MCP is designed to allow fire officers to manually override the smoke control system in the event of a fire. The MCP is designed to comply with prEN12101-9 providing, system healthy, system status, and fault indication.

The MCP also complies with the colour requirements of prEN12101-9 and is orange (RAL 2011).

Smoke Detector

Under Approved Document B, smoke detectors need to be located within the area to be ventilated in the event of a fire. The detectors are required to activate specific SHEVs when smoke is detected. The detectors meet the requirement of prEN12101-9 and EN54. The detectors must solely be used for activation of the SHEVS.



Repeater Panel

The Repeater Panel has been designed to provide system status information for each vent within a smoke ventilation system. The repeater panel would typically be located near the fire service access entrance of the building to provide system indication. Whilst this product is not required under Approved Document B, SE Controls can include this product within the specification to provide system status information in the event of a fire or for system maintenance.



CE CERTIFIED

Compliant to applicable regulations.

Product specifications – SHEVTEC Powered Extract Fans

SHEVTEC Powered Extract Fans

SE Controls' SHEVTEC range of fans are designed to extract hot gases from corridors and lobbies via smoke shafts. All fan sets are tested to European Standard EN12101-3 and installed as part of a fire engineered solution. There are advantages in using mechanical smoke shafts over code compliant natural ventilation shafts, namely: the shaft sizes are generally smaller than ABD compliant shafts (typically 0.6m² vs 1.5m²). Furthermore the fan sets allow greater efficiency in achieving necessary pressure differences thereby allowing increased escape travel distances and reducing the reliance of multiple escape stair cores.

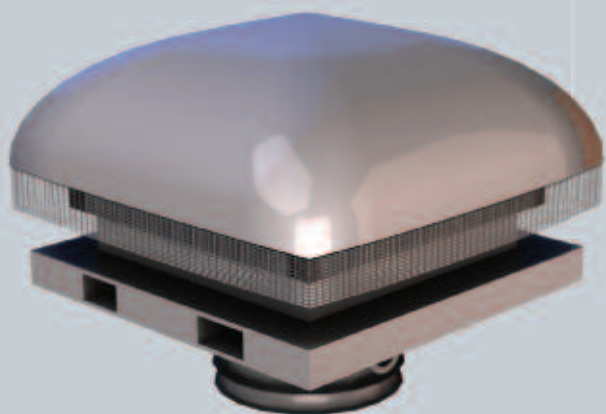
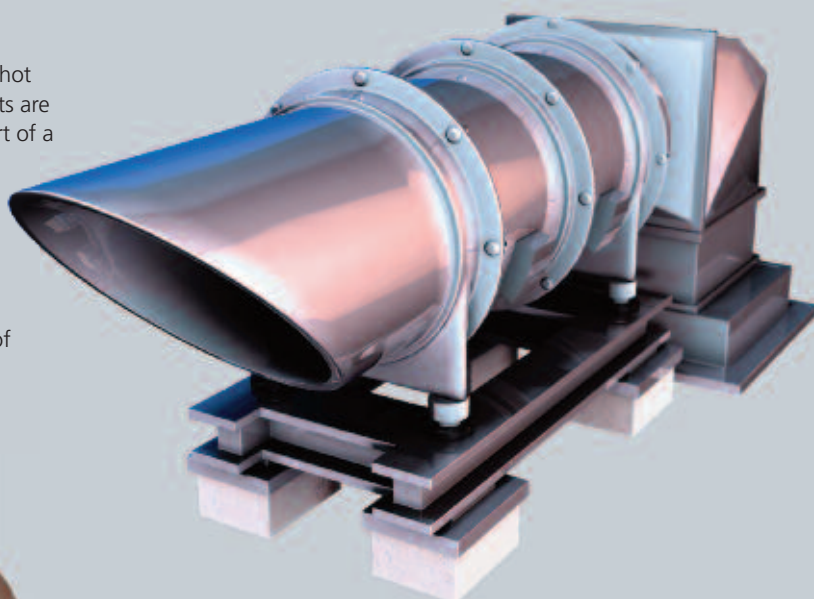

SHEVTEC Powered Extract Fans Available:

Single Speed Fan Set

Designed for use with more than 1 mechanical shaft and natural inlet, the fan set includes duty & standby and auto changeover control. Fire fighting extract is achieved through activation of multiple fan sets.

Supply Voltage: 3 phase 415v.

Tested to EN12101-3.

Dual Speed Fan Set

Designed for use in a mechanically assisted natural ventilation shaft, the fan set includes duty & standby and auto changeover control. Primary speed setting is used for means of escape and secondary speed operates in fire fighting mode.

Supply Voltage: 3 phase 415v.

Tested to EN12101-3.

Fully Reversible Fan Set

Designed for use with further fully reversible fans to smoke shafts to facilitate a fully adaptive SHEV system. Each fan includes an intelligent controller which can activate the fan to operate as a supply fan or an extract fan. The controller can take further inputs from pressure sensors to regulate speed and prevent over/under pressurisation of the lobby. Each fan is capable of providing means of escape and fire fighting functionality.

Supply Voltage: Single phase 230v.

Tested to EN12101-3.



CE CERTIFIED

Compliant to applicable regulations.

Reference Sites



TOP: Roberts Wharf
LEEDS

ABOVE: Beetham Tower
LIVERPOOL

RIGHT: The Mailbox
BIRMINGHAM

FAR RIGHT: Sports City
MANCHESTER



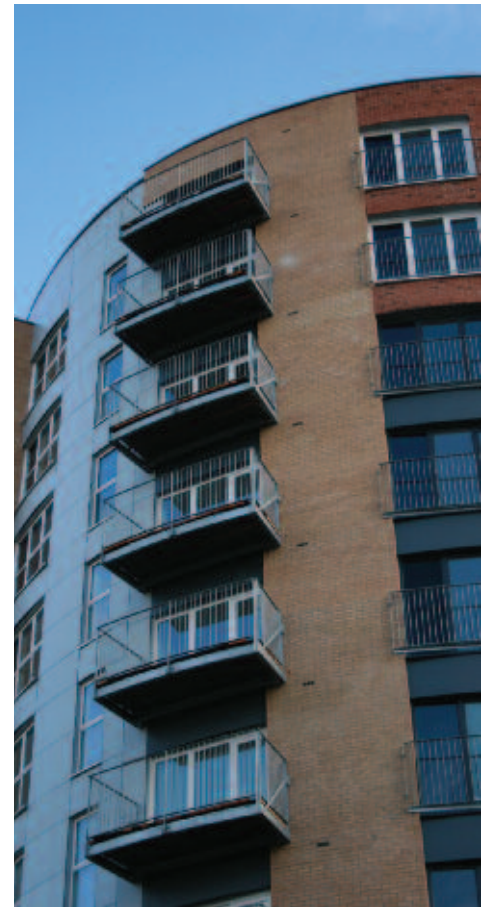



Regulations

Why do you need smoke control systems?

There are two principle reasons for including a SHEV system. The first is to improve conditions in common areas to facilitate safe escape for occupants when a fire occurs and in this instance the SHEVs is used for Means of Escape. The second principle reason is to enable the fire to be fought in its early stages. In this instance the SHEVs is used for Fire Fighting. Depending on the building usage and orientation, the SHEV system may perform one or both of these functions. It is quite usual for the SHEV to enter the means of escape phase through automatic activation and then be switched manually to fire fighting operation once the brigade arrive on site.

So when do you need a smoke control system?

1. If the top floor is more than 4.5m above ground floor level then smoke control may be required subject to travel distances (see below).
2. The nature of occupancy (e.g. sheltered housing) may necessitate some additional fire protection measures – the extent will depend on the form of the development.
3. If the building is above 18m from the fire service access level, then a fire fighting core(s) is required.

Code Compliant Solutions

Means of Escape

In apartment buildings it is assumed that a fire is most likely to occur in an apartment. Each apartment is built as a separate fire rated compartment (between other apartments and the corridor) and contains smoke/heat detectors with integral sounders. The principle is for the occupant of the apartment which is on fire to escape and the other residents to stay put (they may not even know there is a fire). As the occupant of the 'fire' flat escapes, it is probable that some smoke will get into the common corridor or lobby. It is important to ventilate this smoke to prevent it getting in to the common stair and it is the protection of this common stair that is the primary objective. Note that this ventilation also affords some protection to the common corridors/lobbies but this is a secondary benefit – not a primary requirement.

ADB sets out three examples of typical layouts:

- Small single stair building
- Small single stair building with no more than 2 dwellings

What are the allowable travel distances?

Small single stair building

A building will be defined as "small single stair" where:

- The top floor is no more than 11m above ground level
- There are no more than 3 storeys
- The building is not connected to a covered car park

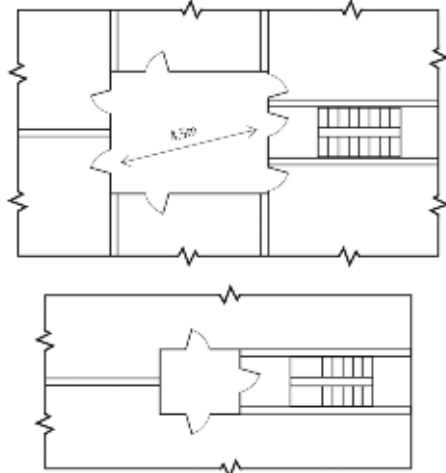

- The staircase doesn't serve ancillary accommodation unless protected from smoke ingress by permanent or mechanical smoke control.

If the building meets the criteria set out above then ADB requires:

- High level (1m²) openable vents at each level or a single openable vent (1m²) at head of stair with remote operation from fire service access level
- Also if the apartment(s) exit directly into the escape stair then a 1m² AOV at the head of the stair is required, operable by smoke detection on ANY floor.

Multiple staircase building

- Maximum travel distance is 30m with exit in more than one direction
- If there is a dead end beyond the staircase then the single staircase example applies.

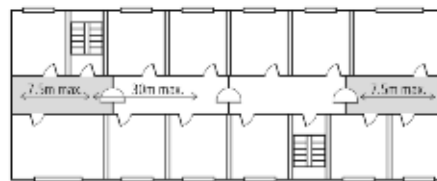
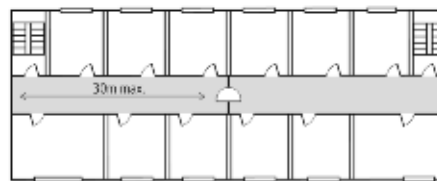

So if ADB requires you to provide smoke control systems what do you need to do?

1. In buildings (other than small single stairs complying with the above) the corridor or lobby adjoining the escape stair should be provided with an (automatic) opening vent.
2. There should also be an (automatic) opening vent, with a free area of at least 1.0m², from the top storey of the stairway to the outside.

What is acceptable as an Automatic Opening Vent (AOV)?

It is common for windows to end of corridors or fire rated doors to be accepted as AOVs. ADB is not a product standard but does make reference to CE marking and the new European BS EN 12101 SHEVs standards. By specifying and providing products which have been tested to these BS EN 12101 standards the designer and builder will be demonstrating that they are complying with Regulation 7 of the Building Regulations 2000 which requires any building works to be carried out with proper materials and in a workmanlike manner. It is not always practical to install tested products. In this instance it would be best practice to install components which can be shown to have undergone some independent testing to support the suitability of their intended usage. For instance an end of corridor AOV window may be fitted with an electric actuator to open the window on receipt of a fire signal. It is good practice to install an actuator which has undergone some kind of heat testing (maybe as a component part of BS EN 12101-2:2003) which is extra low voltage (so it can be operated by a secondary power supply on failure of primary power supply) and which can safely facilitate the closing and resetting of the AOV.

What are the performance requirements of the smoke control system?

The system will typically comprise electrically operated AOVs, control panel(s), dedicated smoke detectors only for operation of the smoke control system, manual control points and fire rated wiring".

In single stair buildings the AOVs on the fire floor and at the head of the stair should be actuated by means of smoke detectors in the common access space providing access to the flats.

In buildings with more than one stair the smoke vents may be actuated manually (typically by a manual control point) and accordingly smoke detection is not required for activation purposes. Importantly where manual actuation is used, the control system should be designed to ensure that the vent at the head of the stair will be opened either before, or at the same time, as the vent on the fire floor. It is therefore recommended that AOVs are installed at the ends of corridors to ensure automatic operation of the "head of stair" vent and to ensure automatic resetting to prevent damage from inclement weather.

Due consideration must also be given to the resetting and ongoing maintenance of the smoke control system. Most AOVs are located within easy access of the occupants. Any automatic operation (opening and closing) needs to take the guidance set out in BS EN 60335-2-103:2003 into account to prevent injury (eg from finger trapping). It is important therefore that any reset operation is performed in sight of the AOV and via a "dead mans handle" principle.

ADB requires that where AOVs are required then they should be either:

Located on an external wall with minimum free area of 1.5m²

Or

Discharge into a vertical smoke shaft (closed at the base) meeting the following criteria:

1. Minimum cross-sectional area 1.5m² (minimum dimension 0.85m in any direction) opening at roof level at least 0.5m above any surrounding structures within a horizontal distance of 2.0m. ceiling of the highest storey served by the shaft. It is important that the point of discharge at the head of the smoke shaft (typically an AOV) should not be adversely affected by external wind conditions.

Care must be taken selecting a suitable AOV product. The opening angles of hinged domes or rooflights should be considered along with deflectors to prevent the risk of positive wind pressure at the head of the smoke shaft.

2. The minimum free area of the vent from the corridor/lobby into the shaft and at the opening at the head of the shaft and at all internal locations within the shaft (e.g. after the installation of safety floor grilles) should be at least 1.0m². Safety grilles are provided to facilitate maintenance access within the smoke shaft. Also where the AOV is located below 1100mm from FFL, the inclusion of a safety floor grille will alleviate the need for additional fall protection.
3. The smoke shaft should be constructed from non-combustible material and all vents should have a fire/smoke resistance performance at least that of an E30Sa fire door. The shaft should be vertical from base to head with no more than 4m at an inclined angle (maximum 30°): and

4. On detection of smoke in the common corridor/lobby, the vent(s) on the fire floor, the vent at the top of the smoke shaft and to the stairway should all open simultaneously. The vents from the corridors/lobbies on all other stories should remain closed. Should smoke be detected on floors other than the fire floors (as a result of the loss of fire compartments), then it is reasonable for the system to activate the AOV on that floor as well. Although ADB does not call for any manual override control of the AOVs, if it is provided, then care must be taken to ensure that the operation of the manual override is not detrimental to the system's effectiveness.

The AOVs should also be located as high as practicable and such that the top edge is at least as high as the top of the door to the stair to encourage the buoyant smoke reservoir to naturally discharge through the AOV before discharging into the escape stair.

The performance of the control panel(s), power supplies and associated components such as manual control points and smoke detectors falls under the BS EN 12101 parts 9 and 10. These standards lay down the test criteria for CE marking control panels and power supplies. Furthermore as the detection system falls

outside of the scope of EN54 or BS 5839, BS EN 12101 addresses the performance requirements for control panels which can have smoke detectors connected directly to them.

It is essential that any control panels have both primary and secondary power supplies capable of operating the system in the event of a fire and a primary power failure.

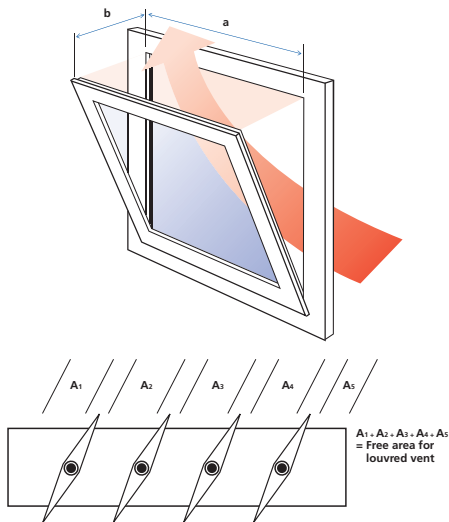

What is a free area?

The free areas referred to in ADB can be achieved in two ways. The first method is to use the declared aerodynamic free area in accordance with BS EN 12101-2:2003 Smoke and Heat Control Systems; specification for natural smoke and heat exhaust ventilators. This method cannot be calculated – rather it is the results recorded in a dynamic test undertaken in laboratory conditions.

Where this figure is not available, then the free area can be calculated by measuring the aperture at right angles to the air flow. In example 1 illustrated (above), the area of the rectangle indicated in red is the free area for louvered vent the free area of the AOV. Note that this free area can never be greater than the maximum throat size of the AOV (i.e. $a \times b$).

Where do I locate the control panel?

There are no statutory regulations regarding the location of the control equipment. However potential risks of damage to control panels should be taken into account when assessing suitable locations. It is not uncommon to see control panels located within smoke shafts as the shaft is fire rated. The control equipment should only be exposed to increased temperatures on the fire floor and above. As all AOVs should remain closed on non fire floors AND the fact that the fire floor AOV has opened due to correct activation, then this would suggest locating control panels within the smoke shaft is a potentially good solution. The control system may comprise of a single enclosure into which all the system fire rated cabling may be connected.

Alternatively the control system may be distributed where every control device contains primary and secondary power and communicate through data networks over fire rated cable.

What manual override is required?

Manual “actuation” is only required to operate vents inside a corridor served by more than one escape stair. This manual actuation must also trigger the AOV to the top of the escape stair through the control system. As the system is for means of escape (and not fire fighting use) it is logical to assume that the escaping occupant would operate the vent on the fire floor. In reality this may be highly unlikely. It may therefore be preferable to install a fully automatic system.

Where there is a small single stair building, then the operation of the AOV to the head of the staircase can be remote and would typically take the form of a manual control point.

The BRE report on the design of smoke shafts requires that each AOV has a manual override. Outside of these specific instances, manual override facilities are not required. Care must be taken when considering how the system can be tested, reset and maintained and it would be sensible to have secure testing/resetting facilities local to each AOV. The function of any such device must be made clear so as not to cause confusion.

If manual control points are designed in to a system, then EN121 01-9 sets out the functional requirements of the manual control point.

What indication is required?

There is no requirement laid down in ADB for any form of indication, repeater panels or mimic panels. Nevertheless the fact that the smoke control system could be the only form of smoke detection to the common areas means that it could be used as a means of giving indication to the arriving fire service to which floor the fire is on. If the smoke control system is used to provide such indication, then this indication should be clear and unambiguous. Typically it will take the form of a small indication panel comprising a legend recording the floors in the building and a status indication adjacent to each floor (eg. activated/not activated). Any form of manual AOV control from this type of device should be thoroughly considered and its function understood.

Where do I locate the smoke detectors?

According to ADB smoke detectors in a single stair building should be located in the common access space providing access to the flats. As the maximum travel distance can never exceed 7.5m a single detector should be sufficient.

Fire Fighting Cores

The Fire Fighting core(s) will need to be kept free of smoke. This can be achieved by opening windows to the external façade. Where this isn't possible it is acceptable to construct a smoke shaft.

Note: BRE report 79204:2002 has become an accepted design method for this, using a 3m² naturally ventilated smoke shaft which is closed at the bottom. The BRE shaft solution requires:

The fire-fighting shaft need only be served by a single smoke shaft serving the fire-fighting lobbies. No stairwell smoke shaft is required.

The smoke shaft should be closed at the bottom and have a single opening at the top to allow ventilation of smoke. The opening at the top of the smoke shaft must not be located where it will be subjected to adverse wind effects (i.e. it should always have negative wind pressure coefficients).

If a fire were to occur on any storey except the top storey, the cross sectional area (geometric free area) of the smoke shaft should be at least 3m² to maintain the fire-fighting stairwell free of smoke. However, for a fire on the top storey, conditions within the stairwell will be at least as good as using external wall mounted ventilation. The shaft should extend a further 'storey height' if protection of the topmost storey is essential.

This alternative design of smoke shaft has been modelled using CFD for buildings up to at least 101 storeys in height.

The ventilator used to vent smoke from the lobby to the smoke shaft should be an Automatically Opening Vent (AOV) (which should be smoke-tight and be provided with manual override), activated on detection of smoke within the fire-fighting lobby. This will induce the stack effect within the shaft prior to the Fire Service gaining access to the fire fighting lobby and ensure that no smoke will enter the stairwell on opening the door connecting the lobby to the stairwell.

The top of the lobby ventilator should be located as close to the ceiling of the lobby as is practicable, and must be at least as high as the top of the door connecting the lobby to the stairwell.

The lobby ventilator should have a geometric free area of at least 1.5m². This ventilator could be in the form of a single high vent or a door type vent. The minimum dimension of both the width and height of this ventilator should be 1m. The stairwell ceiling ventilator should be an AOV (with override controls to open and close the vent), activated on detection of smoke within the fire-

fighting lobby. This will provide the stairwell with a source of inlet air prior to the Fire Service gaining access to the fire-fighting shaft, or to provide ventilation of smoke from the stairwell which may be present on the topmost storey of the stairwell. This ventilator should have a geometric free area of at least 1m².

The access door at the base of the fire-fighting stairwell should remain open once the Fire Service have gained access. This will provide further inlet air to the stairwell, and hence, the lobby.

The door connecting the lobby to the stairwell can be kept open once the Fire Service have gained access to the lobby to provide low level inlet air and improve smoke ventilation to the smoke shaft.

© Building Research Establishment Ltd 2002, Project Report No. 79204

Fire Engineered Solutions

Both the ADB and the BRE Chimney solutions rely on natural SHEVs which in turn require relatively large cross sectional areas within the smoke shaft (1.5m² and 3m² respectively).

It is not always viable to release this amount floor area due the economic cost of giving up this amount of lettable or saleable floor space. The cost benefit analysis of using a code compliant system (which will require minimum design input) versus a fire engineered solution (which by nature will have more design and approval costs) is fundamental to SE Controls approach when designing systems.

If the conclusion is to move away from a code compliant solution then in most cases the SHEVs would include a reduced size smoke shaft (typically 0.5m²). To ensure that the system performs at least as well as a code compliant system the shaft is provided with a duty and standby fan to assist in the extract of smoke from the lobby.

There are many advantages to the use of such a system and these are not only economic. Powered smoke shafts can be more effective than a natural smoke shaft in dealing with cold smoke – a situation that can occur during Fire Fighting phase. Furthermore effective extract rates are considerably higher than a natural system resulting in clearer and more tenable means of escape and fire fighting conditions.

Powered smoke shafts can provide effective SHEVs solution but the design and performance require detailed knowledge and expertise. Because these systems are not code compliant the design team need to work closely with the Approving Authority (preferably as part of the design team) to ensure that all of the stakeholders buy in to the solution. SE Controls provides this to its clients.

There are several variants of the powered smoke shaft SHEVs and the actual variant of the system proposed will depend on the findings of the CFD analysis but typically these systems will be:

- Mechanical extract with natural inlet (ie pull)
- Mechanical extract with mechanical inlet (ie push pull)
- Natural outlet with mechanical inlet (ie push).

It is vital that the optimum location of air inlet and outlet is found as any powered smoke shaft SHEVs cannot afford the risk of stagnant areas in the lobby. Through SE Controls' knowledge and CFD modelling ability, we can ensure the best solution.

It may also be possible to introduce the air inlet through the escape staircase. This type of system needs careful consideration and discussion with the design team to ensure that normal fire compartmentation is not compromised.

In all powered extract solutions, care needs to be taken to avoid excessive depressurisation to the lobby areas.

Excessive depressurisation can result in:

Unacceptable excessive force required to open doors into the escape stair for escaping occupant therefore hindering or even preventing safe escape

The SHEVs actually drawing more smoke into the lobby areas from the fire source thereby making the escape conditions less tenable

How do I sign the system off?

Any SHEV system is an integral part of the life safety strategy for the building occupants. It is important that the system is commissioned, demonstrated and certified as complying with the design methodology. Failure to do this can lead to catastrophic consequences. It is imperative that the smoke control system is installed and commissioned by professional and suitably qualified personnel. Furthermore under the Regulatory Reform Order 2005, it is a building owner's responsibility to maintain that the smoke control system in good working order, failure to keep the system in good working order could result in prosecution.

Product Regulations

It is essential that all SHEVs components operate fully and reliably whenever called upon to do so during their installed life. All of SE Controls products are tested to the relevant and most recent BS EN Product Standards. The EN12101 family of product standards specifically deal with SHEVs components and it is necessary for all system component products to be successfully tested to these standards before they can carry the CE mark. Furthermore stringent and regular Factory Production Control checks via the Company's ISO 9000 accreditation ensure ongoing quality and performance of our products.

By specifying and providing products which have been tested to these BS EN 12101 standards the designer and builder will be demonstrating that they are complying with Regulation 7 of the Building Regulations 2000 which requires any building works to be carried out with proper materials and in a workmanlike manner. It is not always practical to install tested products. In this instance it would be best practice to install components which can be shown to have undergone some independent testing to support the suitability of their intended usage. For instance an end of corridor AOV window may be fitted with an electric actuator to open the window on receipt of a fire signal. It is good practice to install an actuator which has undergone some kind of heat testing (maybe as a component part of BS EN 12101-2:2003). which is extra low voltage (so it can be operated by a secondary power supply on failure of primary power supply) and which can safely facilitate the closing and resetting of the AOV.

EN12101 has the general title Smoke and heat control systems and consists of the following ten parts:

- Part 1, Specification for smoke barriers — Requirements and test methods
- Part 2, Specification for natural smoke and heat exhaust ventilators
- Part 3, Specification for powered smoke and heat exhaust ventilators
- Part 4, Installation and test methods
- Part 5, Design and calculation for smoke and heat exhaust ventilation systems (published as CR 12101-5)
- Part 6, Design and calculation methods and installation procedure for pressure differential smoke and heat control systems
- Part 7, Specifications for smoke ducts
- Part 8, Specifications for smoke dampers
- Part 9, Control equipment
- Part 10, Power supplies

It is expected that the installation of CE marked products into new buildings will become mandatory in the UK imminently.

Whilst it is important to ensure every SHEVs component is fit for purpose, it is also essential that when put together the components will work as a system. SE Controls extensive product range has been designed to be fully interchangeable and compatible and this enables us to bring together SHEVs which operate seamlessly.

Maintenance

The Regulatory Reform (Fire Safety) Order 2005

Background

The Order' applies in England and Wales. It covers general fire precautions and other fire safety duties which are needed to protect 'relevant persons' in case of fire in and around most 'premises'. The Order requires fire precautions to be put in place 'where necessary' and to the extent that it is reasonable and practicable in the circumstances of the case.

Responsibility for complying with the Order' rests with the 'responsible person'.

In a workplace, this is the employer and any other person who may have control of any part of the premises, e.g. the manager or owner. In all other premises the person or people in control of the premises will be responsible. If there is more than one responsible person in any type of premises (e.g. a multi-occupied complex), all must take all reasonable steps to co-operate and coordinate with each other.

If you are the responsible person you must carry out a fire risk assessment which must focus on the safety in case of fire of all 'relevant persons'. It should pay particular attention to those at special risk, such as disabled people, those who you know have special needs and children, and must include consideration of any dangerous substance liable to be on the premises. Your fire risk assessment will help you identify risks that can be removed or reduced and to decide the nature and extent of the general fire precautions you need to take.

If your organisation employs five or more people, your premises are licensed or an alterations notice is in force, you must record the significant findings of the assessment. It is good practice to record your significant findings in any case.

Who enforces the Fire Safety Order?

The local fire and rescue authority (the fire and rescue service) will enforce the Order' in most premises.

The enforcing authority will have the power to inspect your premises to check that you are complying with your duties under the Order.' They will look for evidence that you have carried out a suitable fire risk assessment and acted upon the significant findings of that assessment. If you are required to record the outcome of the assessment they will expect to see a copy.

If the enforcing authority is dissatisfied with the outcome of your fire risk assessment or the action you have taken, they may issue an enforcement notice that requires you to make certain improvements or, in extreme cases, a prohibition notice that restricts the use of all or part of your premises until improvements are made.

If your premises are considered by the enforcing authority to be or have potential to be high risk, they may issue an alterations notice that requires you to inform them before you make any changes to your premises or the way they are used.

Failure to comply with any duty imposed by the Order' or any notice issued by the enforcing authority is an offence.



SE Controls

Lancaster House
Wellington Crescent
Fradley Park
Lichfield
Staffordshire WS13 8RZ

Tel: +44 (0)1543 443060
Fax: +44 (0)1543 443070

Email: sales@secontrols.com
Visit us at: www.secontrols.com

SE Controls is a Registered Trademark

Creating a Healthier and Safer Environment