



www.bohle-group.com

Bohle Patch Swinging Door System

Bohle Self-closing Corner Fitting

The self-closing corner fitting is the most recent product innovation from Bohle. This unique hydraulic system replaces almost all conventional floor springs, and no ground recess is needed. Assembling the door is consequently quicker and easier. Bohle brings a robust design (HD) for big and small glass doors to the market, in addition to the already successful self-closing corner fitting. The self-closing corner fitting from Bohle has been tested for long lifespans and excellent functionality in accordance with EN 1154 and European standards.



No floor cavity necessary, time-consuming recessing eliminated

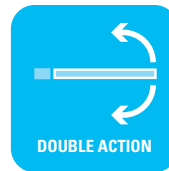

For swing doors



Usable with floor heating

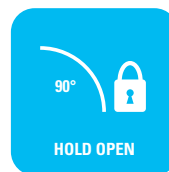

90° range



Filigree design - only a small part is visible

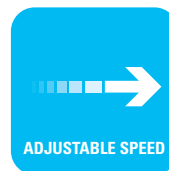

Adjustable closing speed in two directions



Usage in buildings with mid-range footfall

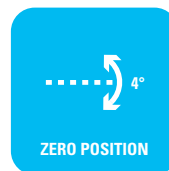

Adjustable zero position $\pm 4^\circ$



Tested over 500,000 cycles



Can be used with a stopper



Quick and Simple Assembly



- ✗ Ground recess
- ✗ Cement replacement
- ✗ Waiting times (cement hardening)
- ✗ Awkward orientation
- ✗ Difficult zero position configuration
- ✗ Wear and tear on the cover plate
- ✗ Bulky design



- ✓ No ground recess
- ✓ Attachment to the ground using four screws
- ✓ No waiting time
- ✓ Quick and simple 2 dimensional construction
- ✓ Comfortable and simple zero positioning of the cover plates
- ✓ Filigree design



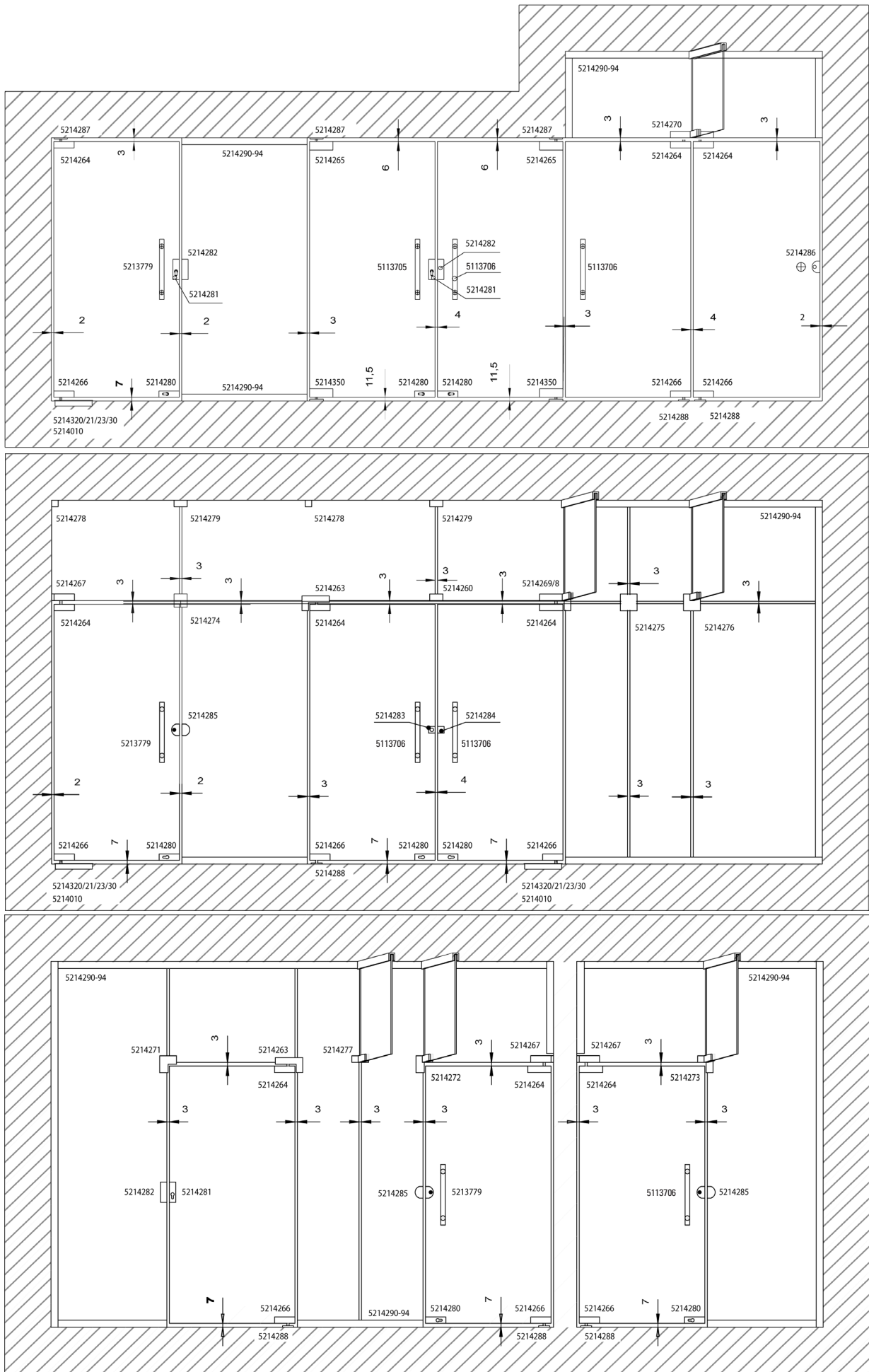

▶ Patch Fitting Corner Set

i Door width 750 - 1000 mm · Description opens both ways · Glass thickness tempered glass 10 - 12 mm · Door weight max. 100 kg · Hold position 90 ° · Door height approx. 2500 mm · Adjustable zero position +/- 4° · ambient temperature - 20°C - +50 °C · Closing speed adjustable 150° - 10° / 10° - 0° · Closing force EN3 · Opening angle max. 150 ° · corrosion-protection class: 3 · suitable for: inside and outside

Included in delivery:

- 1 x BO 5214265 piece corner fitting Bohle Patch PT20 Plus top
- 1 x BO 5214350 piece Bohle self-closing corner fitting
- 1 x BO 5214287 piece ceiling pivot point Bohle Patch PT24

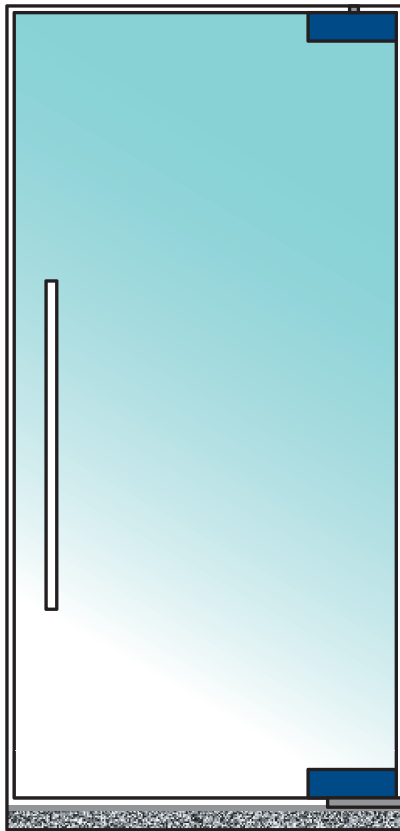

BO 5214265



BO 5214287

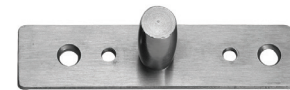

BO 5214350



Art.-Nr.	Description
BO 5214351	Patch Fitting Corner Set

▶ Self-closing Corner Fitting



i Glass thickness tempered glass 10 - 12 mm · Door width 750 - 1000 mm · Door height approx. 2500 mm · Door weight max. 100 kg · Adjustable zero position +/- 4° · Hold position 90 ° · ambient temperature - 20°C - +50 °C · Description opens both ways · Closing speed adjustable 150° - 10° / 10° - 0° · Closing force EN3 · Opening angle max. 150 ° · corrosion-protection class: 3 · suitable for: inside and outside

Art.-Nr.	Description
BO 5214350	Self-closing Corner Fitting

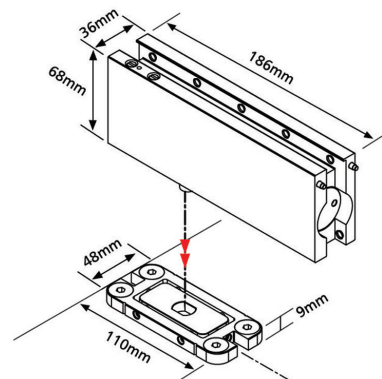
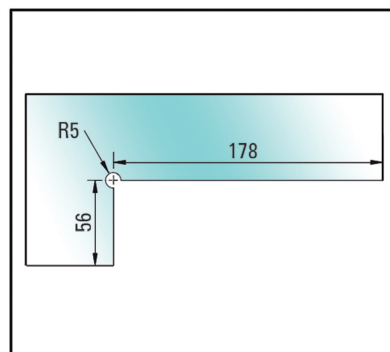

▶ Patch Corner Fitting Set, Heavy Duty

i Door width 750 - 1250 mm · Description opens both ways · Glass thickness tempered glass 10 - 15 mm · Door weight max. 100 kg · Hold position 90° · Door height 2500 mm · Adjustable zero position +/- 4° · ambient temperature -20 - +50 °C · Closing speed adjustable 150° - 10° / 10° - 0° · Closing force EN5 · Opening angle max. 150° · corrosion-protection class: 3 · suitable for: inside and outside

Included in delivery:

1 x BO 5214265 piece corner fitting Bohle patch PT20 Plus top
 1 x BO 5214306 piece Bohle self-closing corner fitting **Heavy Duty**
 1 x BO 5214287 piece ceiling pivot point Bohle Patch PT24



Art.-Nr.	Description
BO 5214352	Patch Corner Fitting Set, Heavy Duty

▶ Self-closing Corner Fitting, Heavy Duty



i Glass thickness tempered glass 10 - 15 mm · Door width 750 - 1200 mm · Door height 2500 mm · Door weight max. 100 kg · Adjustable zero position +/- 4° · Hold position 90° · ambient temperature -20 - +50 °C · Closing speed adjustable 150° - 10° / 10° - 0° · Description opens both ways · Opening angle max. 150° · corrosion-protection class: 3 · suitable for: inside and outside

Art.-Nr.	Description
BO 5214306	Self-closing Corner Fitting, Heavy Duty

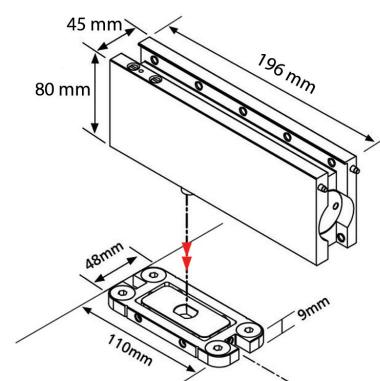
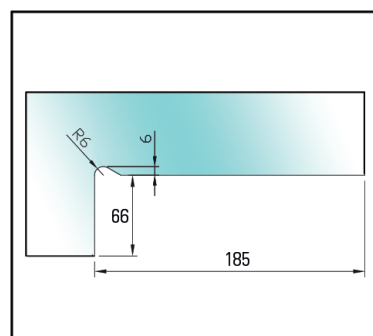

▶ Patch Fitting PT 20 Plus top



Can be used for DIN left and DIN right · With plastic bushing for 15 mm diameter pin · Dimensions suitable for self-closing corner fitting BO 5214350/ BO 5214306

i Glass thickness tempered glass 10 - 12 mm · adjustable pivot point

Art. No.	Finish
BO 5214265	matt stainless steel

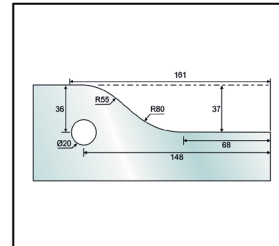
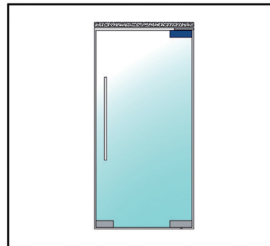
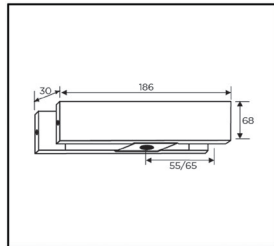

▶ Top Pivot Patch PT 24

For above corner fitting BO 5214264/5214265



i Pin diameter 15 mm

Art. No.	Finish
BO 5214287	matt stainless steel

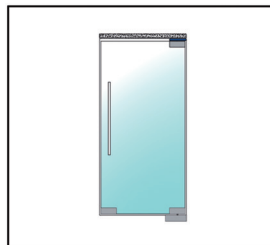
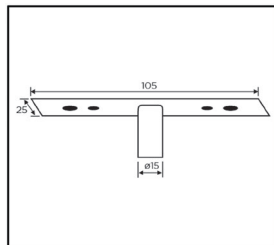

▶ Bottom Patch Fitting PT10

With insert for flat conical floor spring axle



i Glass thickness tempered glass 10 - 12 mm · Pivot adjustable

Art. No.	Finish
BO 5214266	matt stainless steel

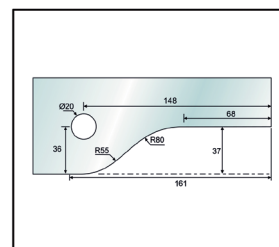
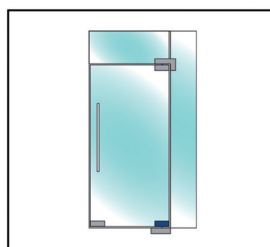
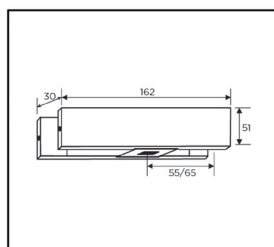

▶ Floor Pivot Patch PT 11

Important: Please use a floor spring for closing the door automatically. · For below corner fitting BO 5214266



i Mounting plate 88 x 55 mm

Art. No.	Finish
BO 5214288	matt stainless steel

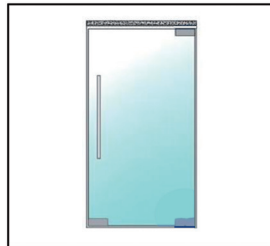
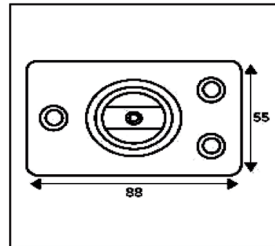

▶ Patch Fitting PT 20 top

With plastic bushing for 15 mm diameter pin



i Glass thickness tempered glass 10 - 12 mm · Pivot adjustable

Art. No.	Finish
BO 5214264	matt stainless steel

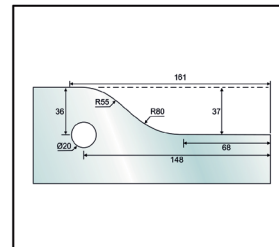
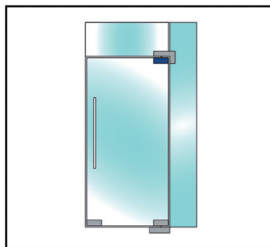
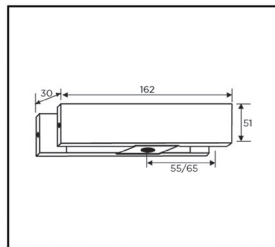

▶ Overpanel Patch Fitting PT 30.3 with Pin Bearing and Screw-On Plate

For wall attachment as counter-bearing for the above corner unit PT20 BO 5214264 · Screw-on plate for wall mounting

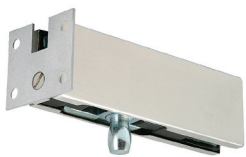

i Glass thickness tempered glass 10 - 12 mm · Pin diameter 15 mm · Pivot adjustable

Art. No.	Finish
BO 5214267	matt stainless steel

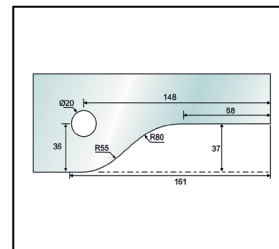
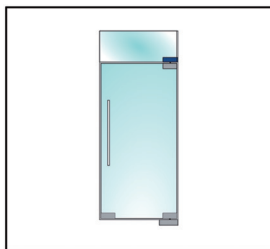
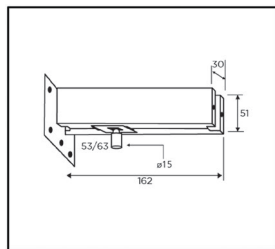

▶ Angled Overpanel Patch Fitting PT 40 with Pin Bearing

Counter-bearing for corner fitting PT20 B05214264



i Glass thickness tempered glass 10 - 12 mm · Pin diameter 15 mm · Pivot adjustable

Art. No.	Finish
B0 5214263	matt stainless steel

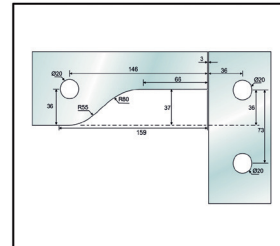
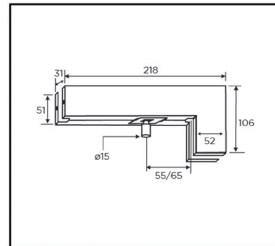

▶ Angled Overpanel Patch Fitting PT 41 LEFT with unilateral reinforcement, with bolt position

Counter-bearing for corner fitting PT20 B05214264



i Glass thickness tempered glass 10 - 12 mm · Pin diameter 15 mm · Pivot adjustable

Art. No.	Finish · DIN Direction
B0 5214268	matt stainless steel · left

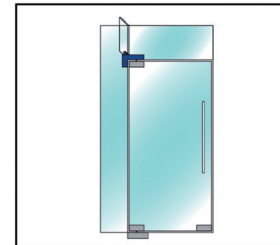
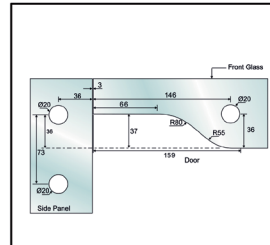
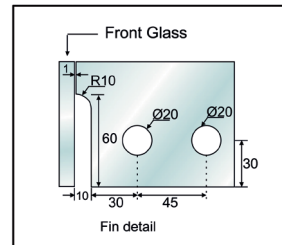
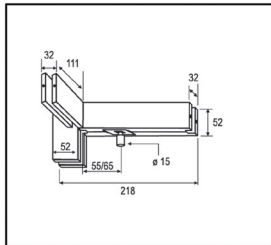

▶ Angled Overpanel Patch Fitting PT 41 RIGHT with unilateral reinforcement, with bolt position

Counter-bearing for corner fitting PT20 B05214264



i Glass thickness tempered glass 10 - 12 mm · Pin diameter 15 mm · Pivot adjustable

Art. No.	Finish · DIN Direction
B0 5214269	matt stainless steel · right

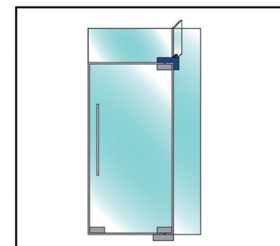
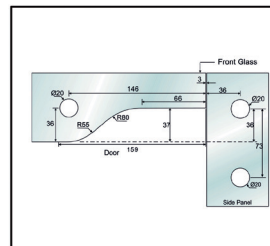
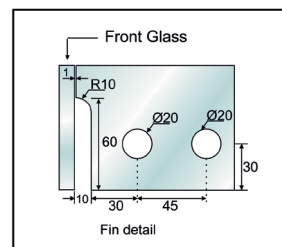
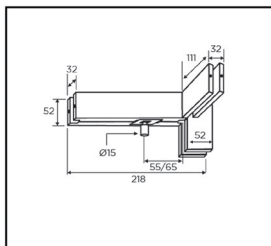

▶ Overpanel Patch Fitting Patch PT 51

With centred unilateral reinforcement and dual-sided bolt position



i Glass thickness tempered glass 10 - 12 mm · Pin diameter 15 mm · Pivot adjustable

Art. No.	Finish
BO 5214270	matt stainless steel

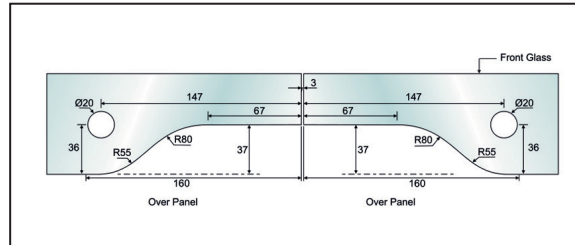
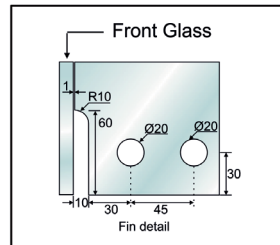
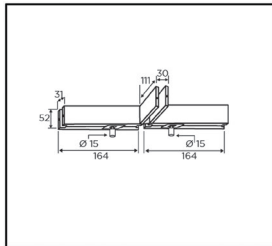

▶ Angled Overpanel Patch Fitting PT 60

Connected head light and side part



i Glass thickness tempered glass 10 - 12 mm

Art. No.	Finish
BO 5214271	matt stainless steel

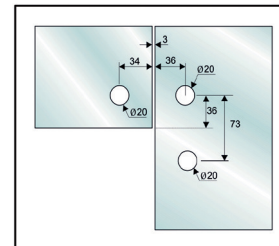
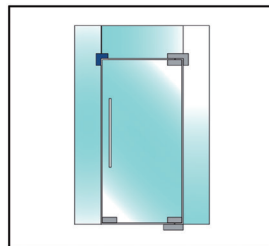
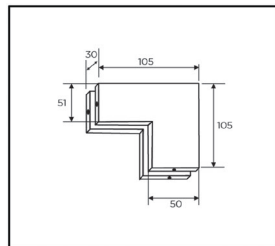

▶ Angled Overpanel Patch Fitting PT 61 with stopper

Connected head light and side part



i Glass thickness tempered glass 10 - 12 mm

Art. No.	Finish
BO 5214274	matt stainless steel

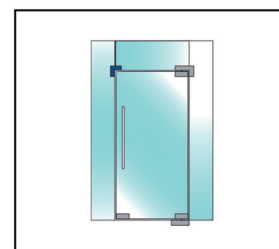
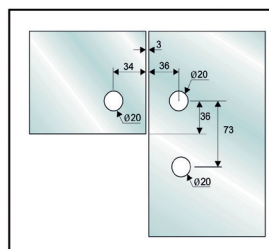
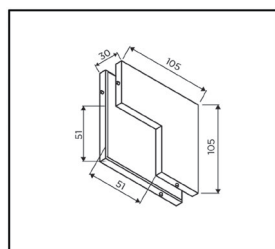

▶ Angled Overpanel Patch Fitting PT 65 LEFT with one side bracing

Connected head light, side part and unilateral reinforcement



i Glass thickness tempered glass 10 - 12 mm

Art. No.	Finish · DIN Direction
B0 5214272	matt stainless steel · left

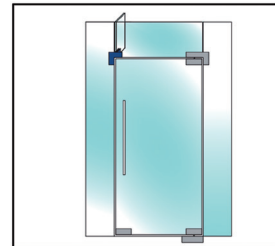
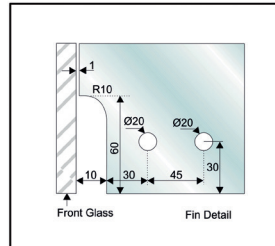
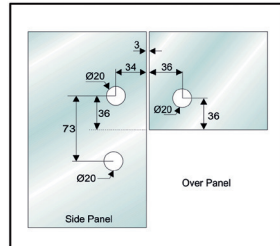
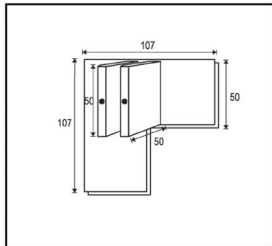

▶ Angled Overpanel Patch Fitting PT 65 RIGHT with one side bracing

Connected headlight, side part and unilateral reinforcement



i Glass thickness tempered glass 10 - 12 mm

Art. No.	Finish · DIN Direction
B0 5214273	matt stainless steel · right

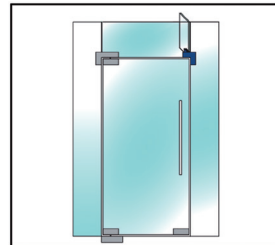
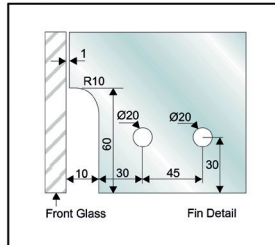
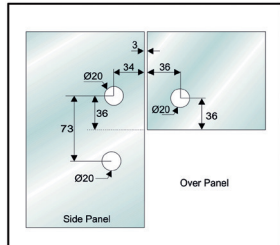
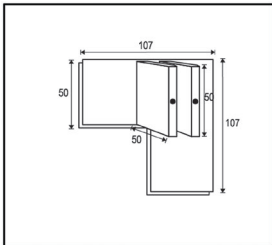

▶ Glass Connector Patch PT 71 with one side bracing

Connected with two fixed parts and unilateral reinforcement



i Glass thickness tempered glass 10 - 12 mm

Art. No.	Finish
B0 5214277	matt stainless steel

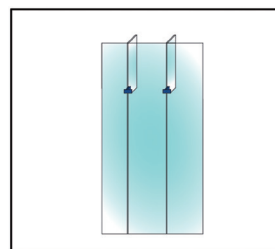
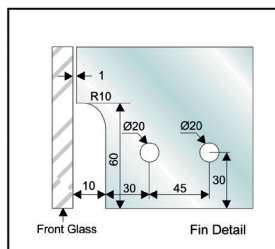
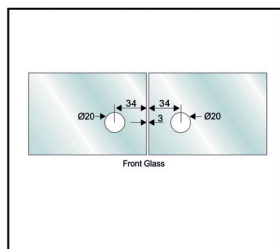
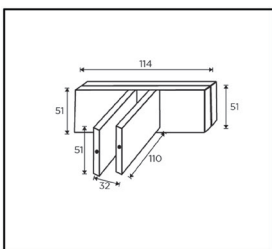

▶ Overpanel Connector Patch with stopper PT72

Connected with two fixed sections



i Glass thickness tempered glass 10 - 12 mm

Art. No.	Finish
BO 5214260	matt stainless steel

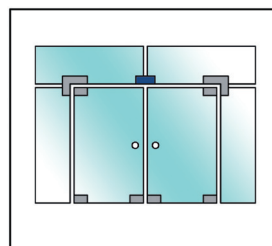
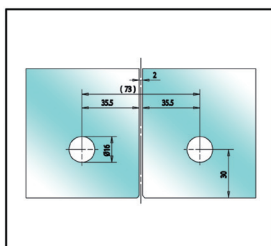
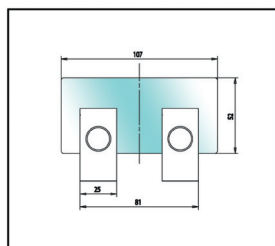

▶ Glass Connector Patch PT 80

Connected with four fixed sections



i Glass thickness tempered glass 10 - 12 mm

Art. No.	Finish
BO 5214275	matt stainless steel

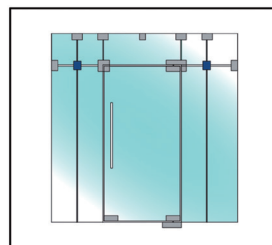
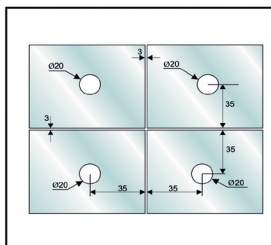
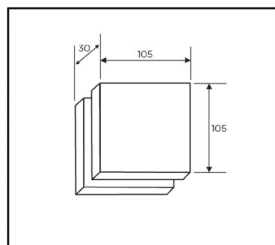

▶ Glass Connector Patch PT 81 with one side bracing

Connected with four fixed sections and unilateral reinforcement



i Glass thickness tempered glass 10 - 12 mm

Art. No.	Finish
BO 5214276	matt stainless steel

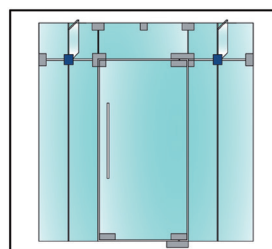
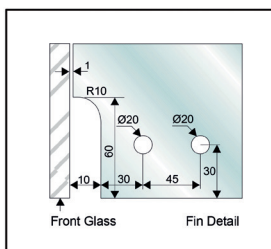
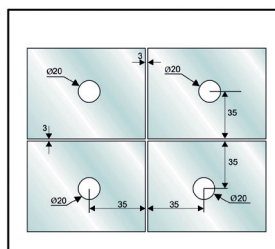
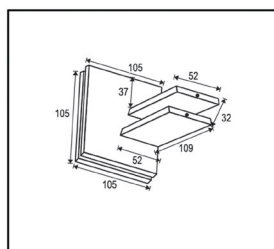

▶ Glass/wall Connector Patch PT 84

Connected with two fixed sections and wall/ceiling/ground



i Glass thickness tempered glass 10 - 12 mm

Art. No.	Finish
BO 5214279	matt stainless steel

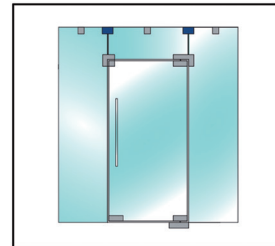
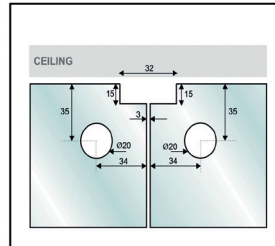
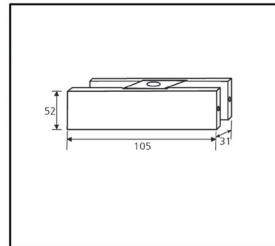

▶ Glass/wall Connector Patch PT 90

Connectors for glass and wall/ceiling/ground



i Glass thickness tempered glass 10 - 12 mm

Art. No.	Finish
BO 5214278	matt stainless steel

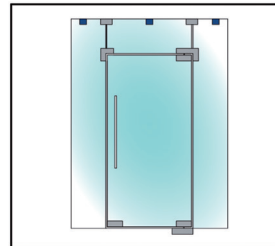
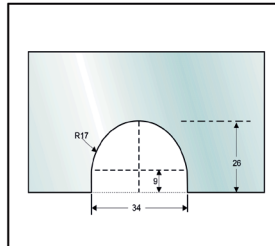
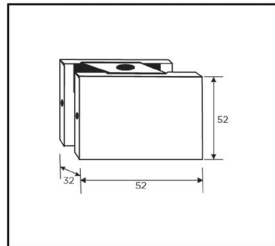

▶ Lock Patch US 10

Can be used for DIN left and DIN right · Euro profile cylinder 60mm (30/30) · incl. 3 keys



i Glass thickness tempered glass 10 - 12 mm · With Cylinder · individual key

Art. No.	Finish
BO 5214280	matt stainless steel

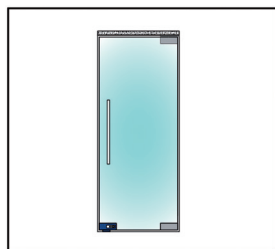
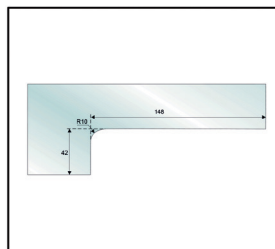

▶ Thumb Turn Lock Bottom/Middle Patch US 20 and Keep



Can be used for DIN left and DIN right · Euro profile cylinder 60mm (30/30) · incl. 3 keys

i Glass thickness tempered glass 10 - 12 mm · With Cylinder · individual key

Art. No.	Description · Finish
BO 5214281	Thumb Turn Lock Bottom/Middle · matt stainless steel
BO 5214282	Keep · matt stainless steel

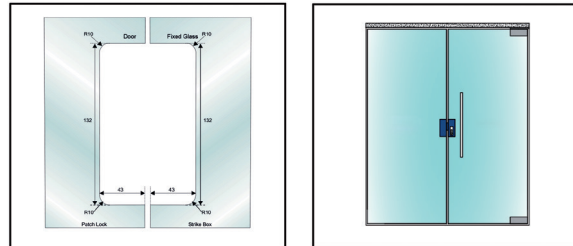

▶ Thumb Turn Lock Bottom/Middle Floor Lock Patch and Keep



Can be used for DIN left and DIN right

i Glass thickness tempered glass 10 - 12 mm

Art. No.	Description · Finish
BO 5214283	matt stainless steel ·
BO 5214284	Keep · matt stainless steel

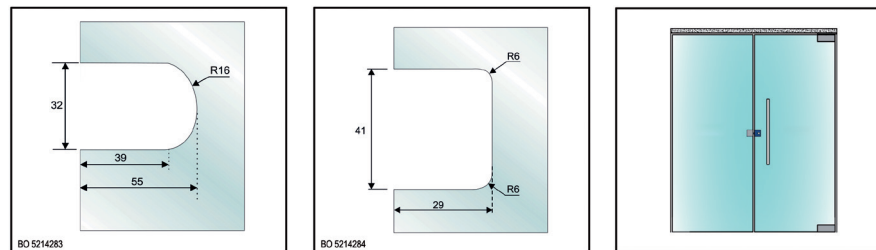

▶ Hook Lock Patch with Keep and hook bolt



Can be used for DIN left and DIN right · No glass cutouts or drill holes required, clamp-on function · suitable for sliding and double doors · incl. 3 keys

i Glass thickness tempered glass 10 - 12 mm

Art. No.	Finish
BO 5214285	matt stainless steel

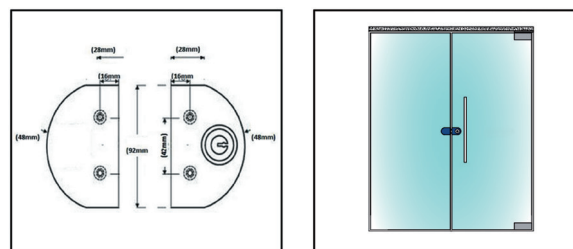

▶ Hook Lock Patch with Keep



Can be used for DIN left and DIN right · No glass cutouts or drill holes required, clamp-on function · suitable for sliding doors · incl. 3 keys

i Glass thickness tempered glass 10 - 12 mm

Art. No.	Finish
BO 5214286	matt stainless steel

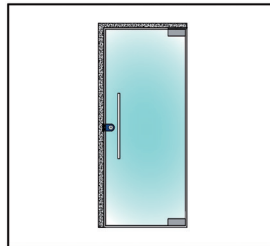
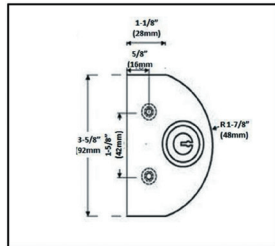

▶ Floor Springs



Minimal floor recess required · Sturdy construction for doors weighing up to 120 kg · High mechanical efficiency for comfortable door use with relatively little effort · Standard 10 mm plug-in flat conical floor spring axle included · Plug-in flat conical floor spring axle not exchangeable · Incl. cement case 40 mm high and matt stainless steel cover plate · Suitable for glass, wooden and aluminium doors · Same design for swing doors and single-action doors · Tested over 500,000 cycles according to EN 1154

i Door opening angle max. 130° · Configurable closing speed 90° - 15° / 15° - 0° · Environment temperature max. -20° - 45°C · Dimensions 305 x 108 x 40.5 mm

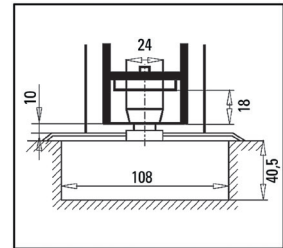

Art. No.	Closing force · Door width · Door weight · Hold position · Weight
BO 5214320	EN1 · max. 600 mm · max. 60 kg · 90° · 5 kg
BO 5214321	EN2 · max. 800 mm · max. 80 kg · 90° · 5.1 kg
BO 5214010	EN3 · max. 1000 mm · max. 100 kg · 90° · 5.2 kg
BO 5214323	EN4 · max. 1200 mm · max. 120 kg · 90° · 5.3 kg

▶ Floor Springs, universal



Easily adaptable to constructional circumstances - even retroactively - thanks to exchangeable plug-in flat conical floor spring axles · Suitable for doors weighing up to 150 kg · Standard 10 mm plug-in flat conical floor spring axle included · Incl. cement case 50 mm high and matt stainless steel cover plate · Suitable for glass, wooden and aluminium doors · Same design for swing doors and single-action doors · Tested over 500,000 cycles according to EN 1154

i Closing force EN1 - EN4 (8Nm - 32Nm) · Configurable closing speed 90° - 15° / 15° - 0° · Door width max. 1200 mm · Door weight max. 150 kg · Door opening angle max. 180° · ambient temperature max. -20° - 45 °C · Weight 4.55 kg · Dimensions 285 x 82 x 49.5 mm

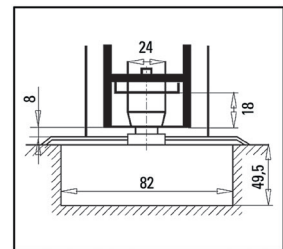

Art. No.	Closing force · Hold position
BO 5214330	EN1 - EN4 (8Nm - 32Nm) · 90°

▶ Clamp-On Profile / Wall Connecting Profile



Bohle wall connecting profile for fixed sidelights

i Glass thickness tempered glass 8, 10, 12, 12.7 mm · Length 3000 mm

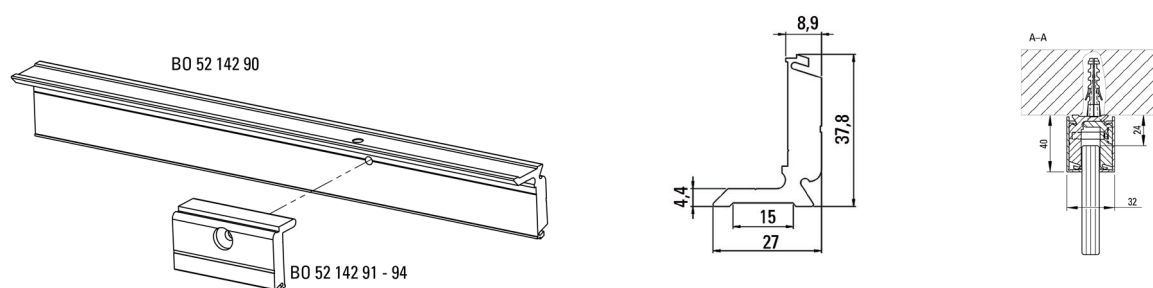

Art. No.	Version
BO 5214290	Base profile

▶ Cover Profile

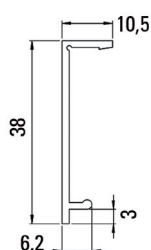

Two are needed for each base profile (one front and one back) · with clip-on function

i Length 3000 mm

Art. No.	Finish
BO 5214295	brushed aluminium anodised
BO 5214296	stainless steel colour

▶ Clamping Parts

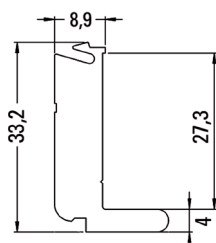

10 pieces are needed for 3000 mm

i Length 60 mm · With screw and gasket · delivery length 3000 mm · Sales unit 1 item

Art. No.	Glass thickness
BO 5214291	Fixed Sidelight 8 mm
BO 5214292	Fixed Sidelight 10 mm
BO 5214293	Fixed Sidelight 12 mm
BO 5214294	Fixed Sidelight 12.7 mm

Germany

Bohle AG
Dieselstraße 10
D - 42781 Haan

T +49 2129 5568-0
F +49 2129 5568-201

info@bohle.de
www.bohle-group.com