



Panorama[®] Series-S

Balustrade system for public access roof areas and balconies



- ✓ Traditional design with the advantages of aluminium
- ✓ Bespoke manufacture, pre-assembled and ready to install

The system



Traditional design with the advantages of aluminium

Traditional design with the advantages of aluminium

Panorama Series-S is an aluminium balustrade system for balconies and accessible roof areas, for use in either, public or private applications.

Its traditional style aims at meeting the design requirements of simplicity and elegance with the added benefits a complete aluminium system brings – lightweight, durable, corrosion free and a fully recyclable material.

Panorama Series-S is also characterised by its ease of installation, using a patented assembly system and a custom delivery in pre-assembled modules.

The system is delivered with detailed layout and installation instructions.

Approved standards, satisfying the requirements of Part K2 of current building regulations, for guards and barriers around buildings:

- BS6180: 2011: Barriers in and about buildings)
- BS EN 1991-1-1, the UK national annex to BS EN 1991-1-4.: Action on Structures

Multiple combinations

Panorama Series-S, with multiple design options, enables a wide range of architectural combinations:

- Glass in-fill size and colour
- Rectangular or round handrails and rails
- Main handrail on top, or through posts

Standard fixing shoes

- On top of floor or parapet
- Side slab fixing, outside or inside of parapet

Delivered ready for installation

The system is pre-assembled by modules in the factory*.

The modules are packaged separately for protection in transit and delivered ready to install on site.

The installation time and room for error and damage is significantly reduced.

The maximum length per modules ready for installation is 3 metres. Coloured rivets are provided.

*Except for the glass panels that may also be glazed in situ.



Panorama Series-S Vision

Glazed infill



Glazed infill

Laminated glass 44.2 class 1 to BS 12600

- Clear glass
- Translucent granite finish glass
- Translucent opal finish glass
- Translucent bronze finish glass

Other finishes available upon request.

Handrails



Round through post



Rectangular through post



Round on top



Rectangular on top



Models

With a (min) 40 mm gap under main handrail



With two intermediate rails



With one intermediate rail



With slab cover glazed infill



System Choices

Handrail

Handrails can be through post or on top of the post.
They can be rectangular or round.



Round through post handrail



Rectangular through post handrail



Rectangular on top handrail



Round on top handrail

Intermediate rails

They can be rectangular or round.

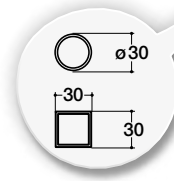

Components

The posts

The panorama Series-S posts are manufactured to your chosen configuration.



Fixing plate accessories

Coloured caps



4 point adjustable base plate to level system.

Fixing



The stand straight Adjustment can also be done using wedge (2mm thick) positioned under the plate.

The layout

Panorama Series-S is delivered ready to install. Labelled in co-ordination with layout details and plans, to assist the correct final site positioning.

For more information on Panorama Series-S installation procedure, visit our web site at www.danialu.co.uk

<3000 mm straight line

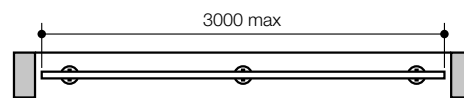

Straight line > 3000 mm

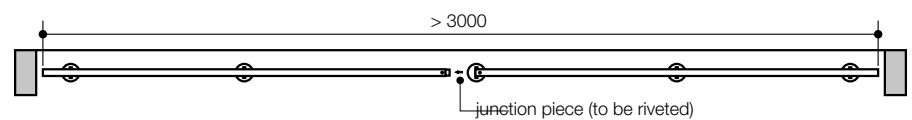

Symmetrical angle solution

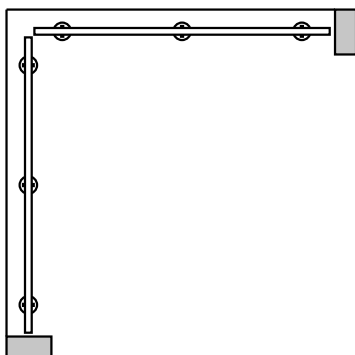

Angle with priority to the front balustrade

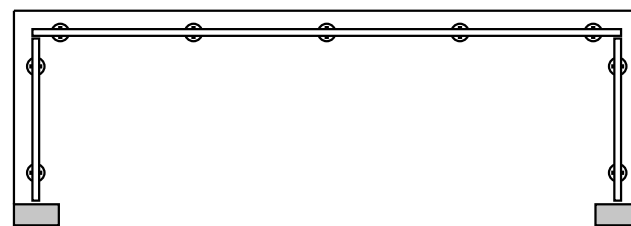

Configuration example for corners

At corners, endcaps ensure a neat finish for the handrail and all termination profiles. The structure is lightened and installation made easier.

Fixing

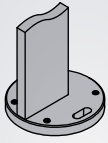

On top of floor/parapet

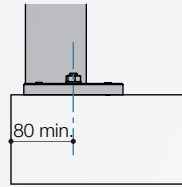

On top of floor

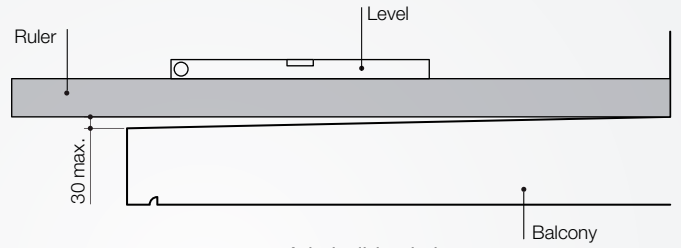

Admissible pitch

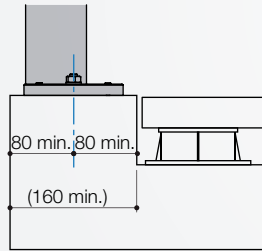

On parapet

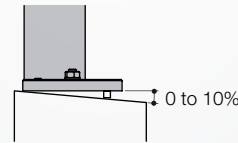

Admissible pitch

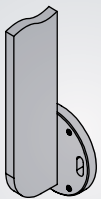
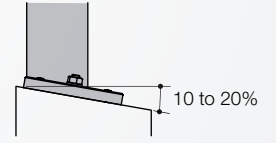

Side fixing

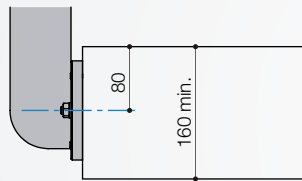

Side slab fixing

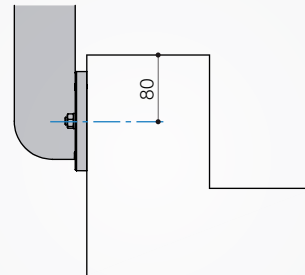

Outside parapet

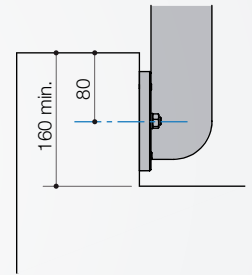

Inner parapet

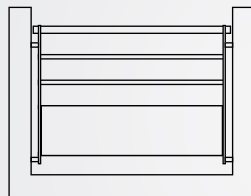

Fixing between walls

Patented system. Registered trademarks and designs.

Subject to modifications.

Examples of use are given for information purposes only.

In the brochure, all measurements are given in mm.

You can download details (CAD / REVIT etc.) and specification texts adapted to your project at:
www.danialu.co.uk



Find this product on our web site www.danialu.co.uk or by using this QR code.

Complementary Products



Systems for finishing and protecting balcony edges

The Dallnet range allows you to permanently prevent the degradation of the slab edge; improves aesthetics and even allows for rainwater collection.

The range Dallnet includes 6 systems:



Dallnet weather strip

Dallnet weather strip

A complete system for dispelling of rainwater away from the slab edge, preventing run off and staining of the exposed slab.



Dallnet gutter

Dallnet gutter

An extruded aluminum system, mechanical fixed to collect and evacuate run off water. Prevents water flowing to balcony areas below.



Dallnet tiles

Dallnet tiles

A range of profiles to protect and form a bead edge for tiled balcony areas. Installed, it also acts as a weather strip.



Dallnet trim

Dallnet trim

A system of protection and cover for the entire balcony edge. It can be used in new or refurbishment projects due to the lightweight aluminium and simple fixing solution.



Dallnet resin

Dallnet resin

A range of profiles to protect and form a bead edge for liquid applied balcony areas. Installed, it also acts as a weather strip.

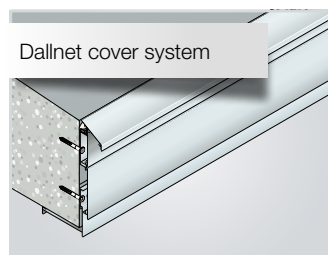

Dallnet cover system

Dallnet cover system

Aesthetic aluminium profiles, designed to be adjustable to cover and protect the full slab edge. The combination of upper and lower profiles and an edge return allows full adaptation to any size slab.

Panorama® Series-S

Company stamp

Order **Request for quotation**

(Tick the options required)

To request a quotation, please give the following information.

In the case of an order, please enclose also a measured survey or a roof plan.

Date:

Company (address):

Contact name:

Telephone: Fax:

Mobile: E-mail:

Type of project new refurbishment **Project reference:**

Stage of project design on site

Handrail

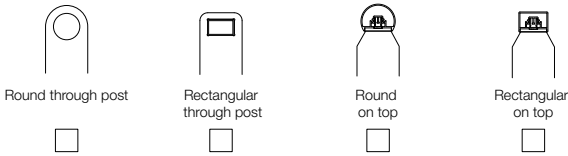

Intermediate rail

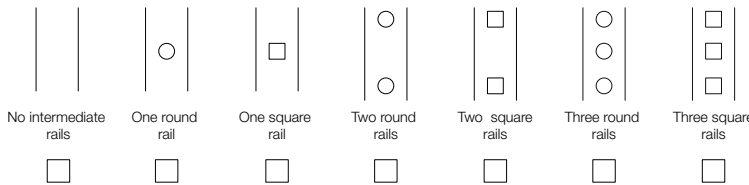

Infill

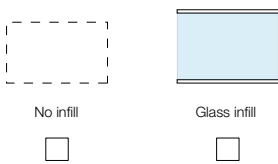

Fixing method

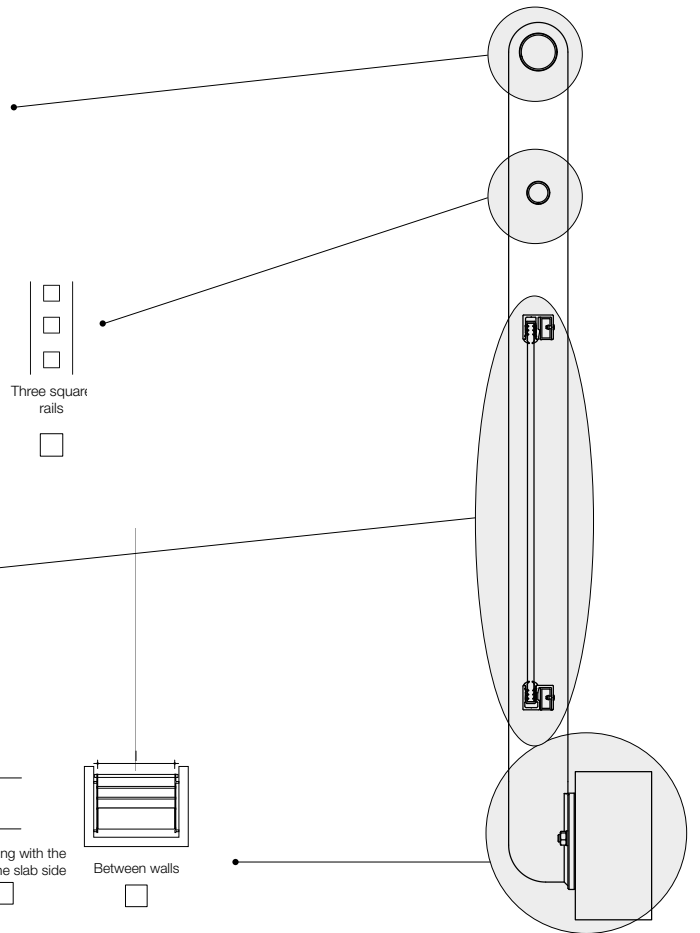
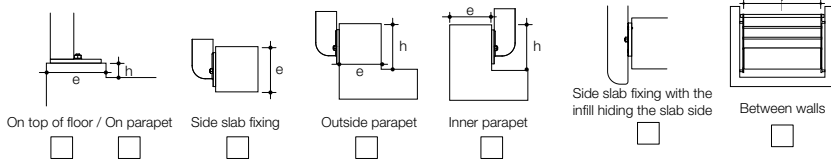

Wedge units

thank you to indicate following dimensions, **in mm** :

e h l

Finish Powder coated danilac ral colour : Fixing caps: grey white black

Quantity Number of linear metres Number of balconies Number of angles

© 03/2016 dani alu • Subject to modifications



dani alu UK Ltd.
Hexagon House, Avenue Four
Witney, Oxfordshire, OX28 4BN

Phone: 01865 595160
E-mail: contact@danialu.co.uk
www.danialu.co.uk