



Norbord®
Make it better

Engineered wood panels

Product range



SterlingOSB® Zero
Strength you can build on



CaberBoard®
Trusted flooring systems



CaberWood MDF®
Legendary performance

NEXT PAGE >>

THE NORBORD WAY

We have been supplying products to Europe for over 50 years and continue to place customers, standards of excellence, control of costs, safety and environmental concerns at the heart of our business.

You can be assured that we'll always have the right products for your needs and we will support you on a product and technical basis, as and when required, through our dedicated product support and technical advice teams.



EXCELLENT SERVICE LEVELS



REPUTATION FOR DELIVERING ON TIME



LOW CARBON FOOTPRINT
as all our products are made in the UK



CONSISTENT QUALITY



012



FSC® C012533

The mark of responsible forestry



INTERACTIVE PDF.

Quickly navigate to a desired section by clicking on the page base controls and side tabs.

THE #1 CHOICE

As one of the world's leading manufacturers of engineered wood-based panel products, we are regularly seen as the No.1 choice in the construction, DIY, and furniture sectors.

This has allowed us to become one of the most trusted and respected suppliers to the trade, with a wide range of panel products to suit a multitude of jobs and applications.



SterlingOSB Zero[®] Strength you can build on

Strong, consistent and great value, the SterlingOSB Zero range is ideal for structural applications.

- SterlingOSB Zero OSB3
- SterlingOSB Zero T&G
- SterlingOSB Zero StrongFix
- SterlingOSB Zero SiteCoat
- SterlingOSB Zero Fire Solutions



CaberBoard[®] Trusted flooring systems

Versatile flooring system for domestic and commercial floors, CaberBoard is stable, durable and easy to lay.

- CaberFloor P5
- CaberDek
- CaberShieldPlus
- CaberAcoustic
- CaberFix D4 (Adhesive)
- CaberFix D3 (Adhesive)
- CaberFix Joint&Joist (Adhesive)
- CaberFix Tape
- CaberFix X-Treme Tape



CaberWood MDF[®] Legendary performance

Engineered with consistent density for multiple use throughout the shop fitting, construction and furniture industries.

- CaberWood MDF Trade
- CaberWood MDF Trade MR
- CaberWood MDF Pro
- CaberWood MDF Pro MR
- CaberWood MDF Industrial

PANEL PRODUCTS FOR EVERY APPLICATION



INTERACTIVE PDF.

Quickly navigate to a desired section by clicking on the page base controls and side tabs.

INDEX

- 02. The Norbord Way
- 08. SterlingOSB Zero - *an overview*
- 14. CaberBoard - *an overview*
- 22. CaberWood MDF - *an overview*
- 28. Product application guide
- 30. Roofing
- 34. Flooring
- 44. Walling / SIPs / Partitioning / Dry Lining
- 48. Timber frames
- 52. Hoarding / Fencing
- 58. Shopfitting
- 62. Furniture
- 66. Other - Moulding and packaging
- 70. Product technical information
- 106. Environmental accreditations
- 109. Customer support

SterlingOSB® Zero®

Strength you can build on

Stronger and tougher than ply with no knots, voids or de-lamination, the SterlingOSB Zero range is great value and ideal for structural applications.

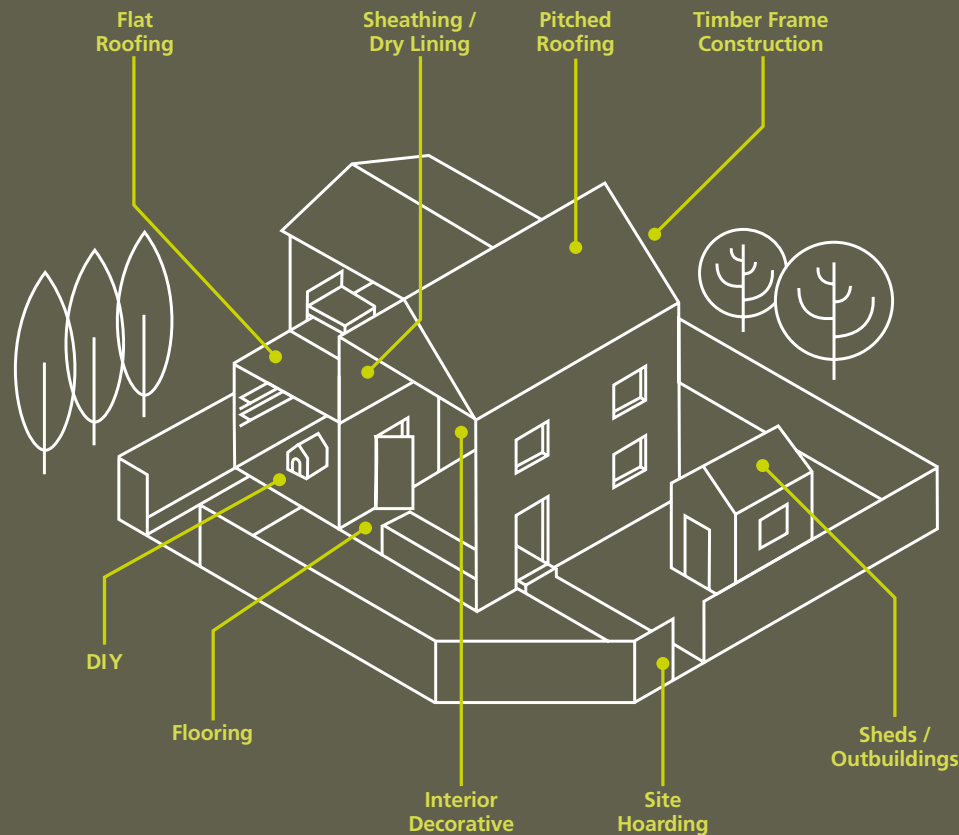

SterlingOSB® Zero® OSB3

For structural use in dry or humid load bearing conditions

SterlingOSB® Zero® T&G

T&G profile strengthens connecting panels for roofing and flooring

SterlingOSB® Zero® StrongFix

Quickly provides secure anchorage areas in metal C-stud dry lining

SterlingOSB® Zero® SiteCoat

Primer coated hoarding, ready for paint or site graphics

SterlingOSB® Zero® Fire Solutions

Reduces the risk of fire spread during construction

A versatile range,
designed for purpose

Recommended product

Application*		SterlingOSB Zero OSB3	SterlingOSB Zero T&G	SterlingOSB Zero StrongFix	SterlingOSB Zero SiteCoat	SterlingOSB Zero Fire Solutions
Use in dry conditions	DIY projects	●	●			
	Garden sheds	●				
	Packaging and pallets	●				
	Shelving / boxing in	●				
	Internal hoarding	●				
	Exhibition displays	●				
	Built-in furniture	●				
	Interior decorative	●				
Use in humid conditions	Site hoardings	●			●	
	Agricultural buildings	●				
	Caravans	●				
	Portable buildings	●				
	Flooring	●	●			
	Wall sheathing	●				
	Flat and pitched roofs	●	●			
	Timber frame	●	●	●		●
	Dry lining			●		

*The above table provides general guidance only. It is recommended that you conduct small scale pilot tests to ensure you have the correct grade for your end use.

SterlingOSB® Zero OSB3

Highly versatile board for structural use in load bearing dry or humid conditions.

- Uniform, high quality panels
- No knots, voids or de-laminating problems
- Stronger and tougher than most softwood plywood
- Easy to work with
- Nails can be driven as close as 8mm from panel edge without splitting
- Can be finished with most popular surface treatments
- The first and only UK made OSB with zero-added formaldehyde

SterlingOSB® Zero T&G

Tongue and groove board with a smooth surface finish, for roofing and flooring.

- T&G profile helps elongate lifespan of boards by reducing movement
- Fully BBA approved
- Machined to exact tolerances
- Smooth surface designed to offer excellent finish with most surface treatments
- No knots, voids or de-laminating problems
- Stronger and tougher than most softwood plywood

Product

Product	Thickness mm	Length mm	Width mm	Edge profile	Sheets per pack
SterlingOSB Zero OSB3	9, 11, 15, 18	2400	1200	SE	100, 82, 60, 50
	9, 11, 15*, 18	2440	1220	SE	100, 82, 60, 50
	9	2700	1200	SE	100
SterlingOSB Zero T&G	18, 22*	2400	1200	TG2	50, 41
	18, 22*	2440	1220	TG2	50, 41
	18	2400	590	TG4	100
	18	2440	590	TG4	100

*Minimum order quantity applies

SterlingOSB® Zero® StrongFix

Pre-prepared for quick installation in metal C-stud dry lining.

- Precision machined panels fit easily into metal C-stud frames with 600mm centres for a fast, flush-fit installation
- Provides a strong fixing point for fixtures and fittings up to 400kg anywhere on the panel
- All the inherent benefits of SterlingOSB Zero OSB3 – no knots or voids
- Meets BS 5234-2 standard and CE marked
- Ideal for fixing cabinets, radiators, wash basins, railings etc to stud walls

SterlingOSB® Zero® SiteCoat

Filled and primer coated on one side, ready for paint or site graphics.

- For the application of logos and other marketing info on site hoardings
- Factory primed white or with a choice of colour*
- Primed on all four edges improves durability over untreated plywood or OSB
- Standard fixing and woodworking methods
- Easy and economical
- Eco-friendly, non-solvent coating

*Minimum order quantity applies to colour choice other than white

Product	Thickness mm	Length mm	Width mm	Edge profile	Sheets per pack
SterlingOSB Zero StrongFix	18	2400 [†]	597 [†]	SE	50
SterlingOSB Zero SiteCoat	18	2440	1220	SE	50

[†] Other sizes are available on request

SterlingOSB® Zero® Fire Solutions

Developed specifically in response to the STA (Structural Timber Association) published guidelines to reduce fire spread during the construction phase.*

- Fully compliant with the Building Regulation fire protection requirements** to match the generic categories of timber frame in STA published guidelines
- Reduces potential radiant heat emissions to reduce the risk of fire spread to neighbouring buildings during construction
- All the inherent benefits of SterlingOSB Zero OSB3
- **SterlingOSB Zero FS-300**
SterlingOSB Zero OSB3 15mm with intumescent coating on both sides of the panel.
- Suitable for FR Build decking

*SterlingOSB Zero Fire Solutions is intended to reduce the risk of fire spread during construction before other fire resistant measures are in place. Full details available upon request.

**When used in conjunction with insulation

Product	Thickness mm	Length mm	Width mm	Edge profile	Sheets per pack
SterlingOSB Zero FS-300	15	2400	1200	SE	60

SterlingOSB Zero conforms with



CaberBoard®

Trusted flooring systems

An advanced range of flooring products designed to fit all applications; new-build, replacement, domestic and commercial.

CaberFloor P5®

The UK's most specified moisture resistant P5. Stable, durable and easy to lay, it's not difficult to see why.

CaberDek®

P5 with a strong, waterproof and slip-resistant peelable film, that when removed leaves a clean finished floor.

CaberShield+®

An advanced product with a permanent waterproof coating on both sides for flooring when the roof's off.

CaberAcoustic®

P5 flooring panel designed to reduce both impact and airborne transmitted sounds.

CaberFix®

A range of powerful sealing and fixing systems specifically developed for CaberBoard flooring.

What's best for you?

A guide to choosing the most suitable flooring system

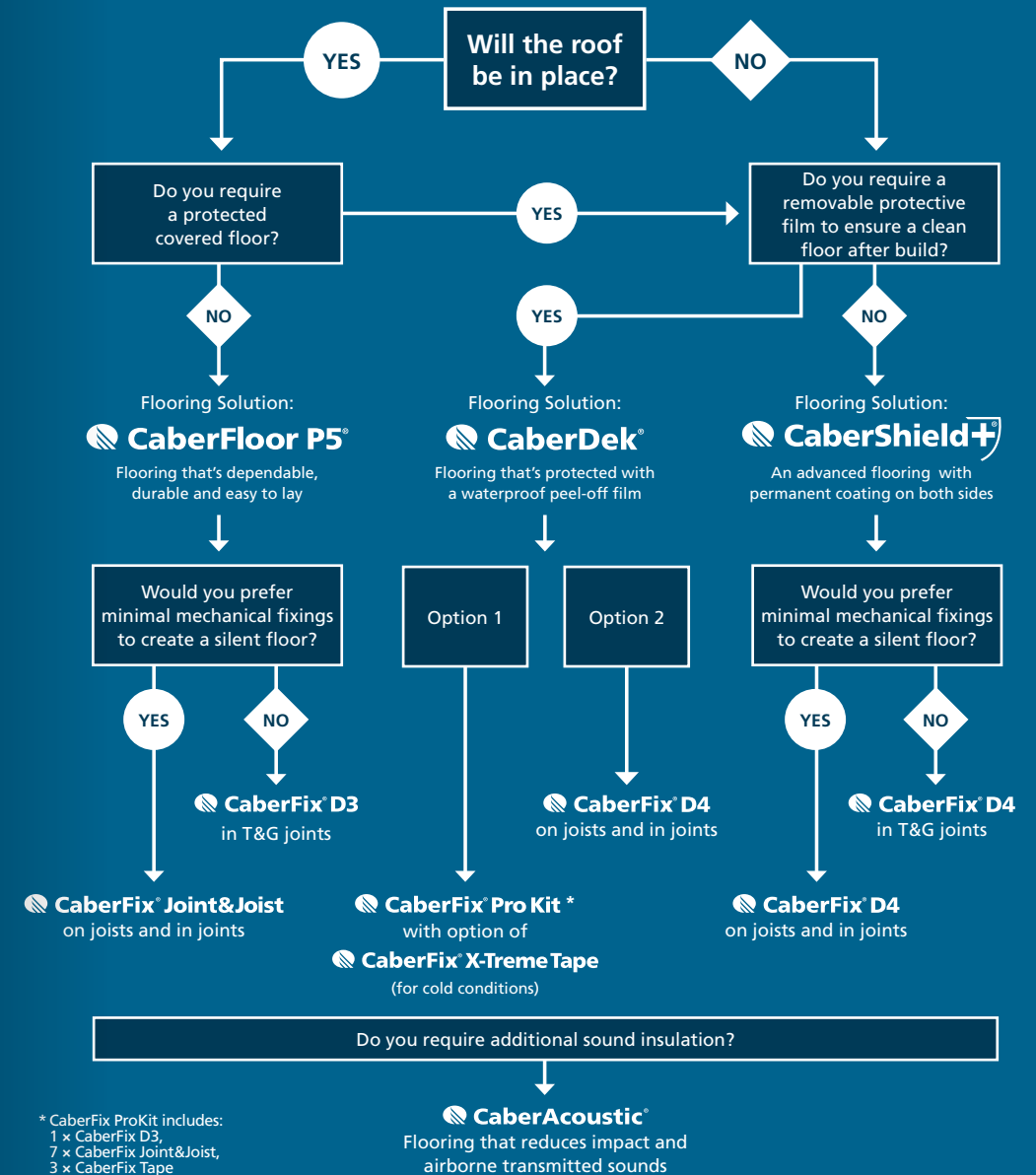

* CaberFix ProKit includes:
1 x CaberFix D3,
7 x CaberFix Joint&Joist,
3 x CaberFix Tape

CaberDek's factory-installed removable protective film ensures installation is quick and the final floor is clean after the build.



Flooring solutions

CaberFloor P5®

High-strength P5 wood particleboard for domestic and most other floors.

- Square-edged or tongue and groove profile
- Stable, durable, easy to lay
- Moisture-resistant
- Provides an excellent surface for subsequent floor laying operations
- Removes the need for intermediate noggins
- Strong and robust

CaberDek®

P5 grade flooring protected from the elements and construction mess.

- Incorporates a strong waterproof and slip-resistant peelable film
- Impact, puncture and tear resistant film withstands high site traffic
- 44dB sound reduction when used in conjunction with leading I-beam and insulation manufacturers
- BBA approved for 42 days exposure* when installed with CaberFix
- Complies with BS EN312: part 5

CaberShield+®

An advanced product designed to keep you building in all weathers.

- Double-sided protection with a tough, permanent waterproof coating
- BBA approved for 60 days exposure* when used with CaberFix D4 adhesive
- Non-slip, safe working platform that withstands high site traffic
- Easy to slide into place with smooth underside
- Colour coded sides to make it easy to identify top surface
- All the inherent benefits of CaberFloor P5

CaberAcoustic®

CaberFloor P5 particleboard with an acoustic layer to reduce sound transmission.

- Available as 18 or 22mm CaberFloor P5 with a 10mm sound reducing layer
- Reduces impact sounds transmission by ΔL_w 19dB†
- Contributes to airborne noise reduction††
- Made in the UK using eco recycled felt
- All the inherent benefits of CaberFloor P5

† 19dB sound reduction applies when CaberAcoustic is installed on its own. Greater reductions applicable (see table) when used within a system for noise transference reduction.

†† When used in the right system.

*When installed according to manufacturer's instructions

Recommended product

	CaberFloor P5	CaberFloor P5	CaberDek	CaberDek	CaberShieldPlus	CaberShieldPlus	CaberAcoustic	CaberAcoustic
Thickness (mm)	18	22	18	22	18	22	28	32
Dry Domestic	●	●	●	●	●	●	●	●
Domestic new build	●	●	●	●	●	●	●	●
Refurbishment	●	●	●	●	●	●	●	●
Commercial		●		●		●		●

*The above table provides general guidance only. It is recommended that you conduct small scale pilot tests to ensure you have the correct grade for your end use.

Product	Thickness mm	Length mm	Width mm	Edge profile	Sheets per pack
CaberFloor P5	18	2400	600	TG4	80
	22	2400	600	TG4	66
CaberDek	18	2400	600	TG4	80
	22	2400	600	TG4	66
CaberShieldPlus	18	2400	600	TG4	80
	22	2400	600	TG4	66
CaberAcoustic	28†	2400	600	TG4	40
	32†	2400	600	TG4	36

Other grades and thicknesses of particleboard also available – see page 82 for details

† Including 10mm acoustic layer



A range of adhesives and tapes specifically developed for use with CaberBoard flooring.

CaberFix® D4

A one-bottle adhesive and sealing solution that provides BBA approval when used to install CaberDek and CaberShieldPlus.

CaberFix® Joint&Joist

A fast-setting PU adhesive and sealant that provides a silent, flexible bond and waterproof seal in CaberBoard flooring.

CaberFix® X-Treme Tape

A highly durable, acrylic tape specifically for installing CaberDek in harsh winter conditions.

CaberFix® D3

A powerful, fast-setting D3 PVA glue designed for sealing and fixing tongue and groove flooring.

CaberFix® Tape

A polyethylene-coated cloth tape for sealing CaberDek perimeters to walls and sealing joints.

*When installed according to manufacturer's instructions



CaberShieldPlus and CaberFix D4 flooring system meets BBA approval for up to 60 days exposure.*

Adhesives and sealing solutions

CaberFix® D4

A one-bottle adhesive and sealing solution that provides BBA approval* on CaberDek and CaberShieldPlus.

- Bonds T&G joints, flooring to joists, and seals exposed perimeter and edges
- Full BBA approval for up to 60 days exposure when installed according to manufacturer's instructions
- Solvent-free, one-component polyurethane adhesive
- Foaming adhesive can be seen in the joints making sure a seal is made
- Easy to use, easy to hold 1kg bottle with easy flow nozzle
- Meets BS EN 204

CaberFix® Joint&Joist

A fast-setting, strong PU adhesive and sealant designed for use with CaberBoard flooring.

- Provides a strong, silent bonding layer between floor and joists
- Creates a waterproof seal in T&G joints
- Bonds in damp conditions to a variety of materials
- Fast-setting and easy to use
- Strong and flexible bond with good gap-filling properties

*When installed according to manufacturer's instructions

CaberFix® D3

Powerful, water resistant D3 glue designed for sealing and fixing tongue and groove flooring.

- Fast-setting, it forms a strong, hard and rigid glue line
- D3 PVA has superior properties over standard PVA glues
- No fillers required
- Full BBA approval for 42 days exposure when installed according to manufacturer's instructions
- Conforms to DIN EN 204 D3 and BS 476 part 6

Product application*

	CaberFloor P5	CaberDek	CaberShieldPlus	CaberAcoustic
CaberFix D4		●	●	
CaberFix D3	●	●		●
CaberFix Joint&Joist	●	●	●	●
CaberFix Tape		●		
CaberFix X-Treme Tape		●		

*The above table provides general guidance only. For further advice contact technical.

CaberFix® X-Treme Tape

Highly durable and scuff-resistant flooring joint tape, formulated to withstand severe winter conditions.

- Bonds well in damp conditions and doesn't lift when wet
- Will work in conditions up to, and including, minus 21 degrees C
- High tack strength won't lift in tough working conditions
- Provides BBA approval for 42 days exposure when installed as part of the CaberFix sealing and fixing system*

CaberFix® Tape

Polyethylene-coated cloth tape for sealing CaberDek flooring during construction.

- 100% waterproof for sealing exposed joints and perimeter edges
- Easy to tear and conform to irregular surfaces
- UV resistant for durability
- Provides BBA approval for 42 days exposure when installed as part of the CaberFix sealing and fixing system*

Product quantities

	Product	Size	Format	Units per box
Adhesives	CaberFix D4	1kg	Bottle	12
	CaberFix D3	1kg	Bottle	12
	CaberFix Joint&Joist	310ml	Cartridge	12
Tapes	CaberFix X-Treme Tape	48mm x 50m	Roll	12
	CaberFix Tape	48mm x 50m	Roll	24
Kits	CaberFix Pro Kit [†]	50m ²	Mix	1

[†] 1 x CaberFix D3, 7 x CaberFix Joint&Joist, 3 x CaberFix Tape

CaberBoard conforms with



The mark of responsible forestry



** Dependent on type



CaberWood MDF®

Legendary performance

In a league of its own with great finishing, fantastic holding and impressive routing.

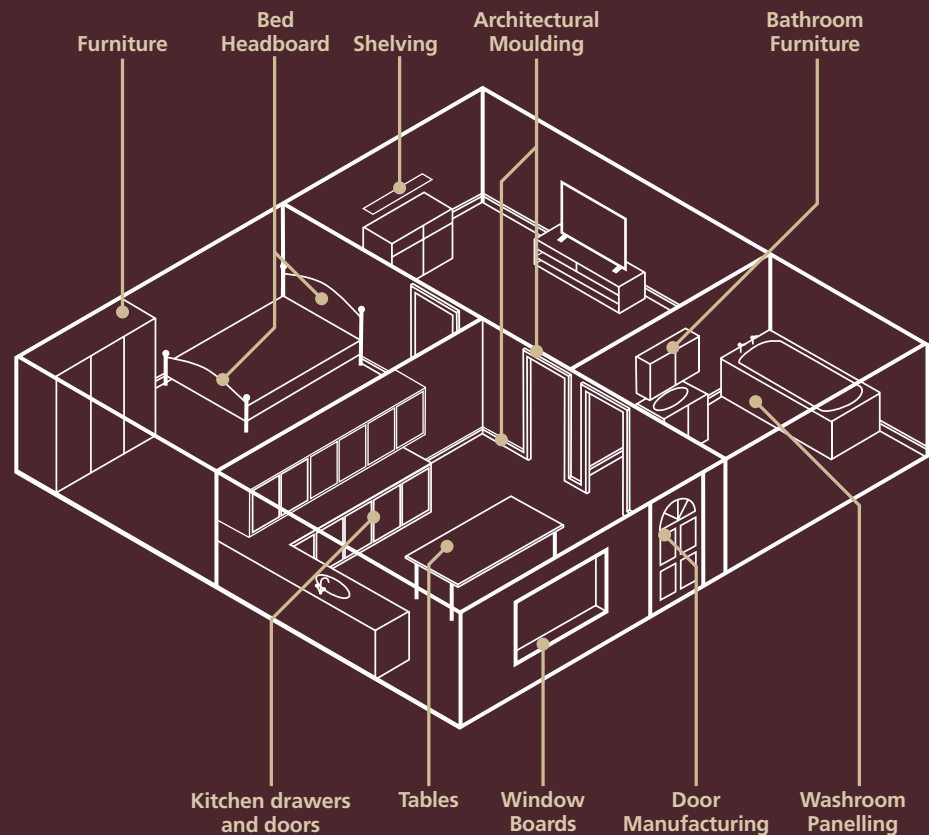

CaberWood MDF® Trade

A versatile lightweight board ideal for end uses where weight is a factor

CaberWood MDF® Trade MR

All the benefits of CaberWood MDF Trade with the added advantage of moisture resistance

CaberWood MDF® Pro

Consistent density ensures cutting and routing need minimal finishing

CaberWood MDF® Pro MR

Premium grade MDF that performs even in occasionally wet / humid environments

CaberWood MDF® Industrial

The ultimate MDF, ideal for deeper routing and advanced finishing techniques

General purpose MDF, renowned for its performance

CaberWood MDF® Trade

High quality, lightweight MDF with enhanced smooth surface and consistent density.

- Enhanced surface gives a great finish – ideal for painting, paper foils and veneers
- Consistent density ensures it saws, drills, shapes and routs cleanly and easily
- Engineered from UK sourced wood and BS EN 622 parts 1 and 5 accredited

CaberWood MDF® Trade MR

Lightweight and moisture resistant board for general purpose joinery.

- Performs well in occasionally wet or humid environments
- High quality fibre and internal bond strength gives excellent holding of screws and fastenings
- Saws, drills, shapes and routs cleanly and easily
- No splintering or chipping

Application*

Recommended product	Shop fitting	General purpose joinery	Furniture	Wall panelling	Kitchen & bathroom joinery	Exhibition displays	Caravan manufacture	Door manufacture	Fire surrounds	Window boards	Mouldings	Wrap mouldings	Architectural mouldings
CaberWood MDF Trade	●	●	●			●							
CaberWood MDF Trade MR	●	●	●		●	●	●						
CaberWood MDF Pro	●	●	●	●				●	●		●		●
CaberWood MDF Pro MR	●	●	●	●	●		●	●		●			●
CaberWood MDF Industrial	●				●			●	●		●	●	●

*The above table provides general guidance only. It is recommended that you conduct small scale pilot tests to ensure you have the correct grade for your end use.



CaberWood MDF Trade is perfect for interior joinery where a light panel and fixing strength are essential.

Product details	Thickness mm	Length mm	Width mm	Edge profile	Sheets per pack
CaberWood MDF Trade	12	2440	1220	SE	60
	12	3050	1220	SE	64
	15	2440	1220	SE	56
	15	3050	1220	SE	50
	18	2440	1220	SE	48
	18	3050	1220	SE	42
	22	2440	1220	SE	32
	22	3050	1220	SE	32
	25	2440	1220	SE	35
	25	3050	1220	SE	30
CaberWood MDF Trade MR	12	2440	1220	SE	60
	12	3050	1220	SE	64
	15	2440	1220	SE	56
	15	3050	1220	SE	50
	18	2440	1220	SE	48
	18	3050	1220	SE	42
	22	2440	1220	SE	32
	25	2440	1220	SE	35
	25	3050	1220	SE	30

Premium quality and well suited to detailed working

CaberWood MDF® Pro

A premium grade MDF with a consistent density for high quality finishing.

- Straight-forward machine and surface finishing
- Consistent density ensures cutting and routing need minimal finishing
- Excellent holding of screws and fastenings
- Saws and drills easily, shapes and routs cleanly

CaberWood MDF® Pro MR

Premium grade MDF that performs well in occasionally wet or humid environments.

- Consistent high density across the board allowing the most intricate edge profiling and surface routing
- Enhanced, smooth surface is ready for paint, paper foils and veneers
- High quality fibres and internal bond strength for superior holding of screws and fastenings



CaberWood MDF Pro's consistent density ensures a high quality finish.

CaberWood MDF conforms with



CaberWood MDF® Industrial

Denser design for deep profiles and consistent performance.

- Suitable for use with all woodworking machines and hand tools
- High density design allows advanced finishing and deep, angular profiles
- Gives a superior routed finish
- Enhanced, smooth surface is ready for paint, paper foils and veneers

CaberWood MDF Pro (SE)

Panel Size (mm)	Sheets per pack per Panel thickness (mm)										
	6	9	12	15	18	19	22	25	30	36	38
2440 × 1220	60	60	60	48	40	37	32	30	24	20	20
2440 × 1525	-	-	-	-	32	-	-	24	-	-	-
2440 × 1830	-	-	-	36	30	-	-	24	18	-	-
3050 × 1220	78	60	48	40	32	-	32	24	18	16	15
3660 × 1220	-	-	-	18	24	-	24	24	20	-	-

CaberWood MDF Pro MR (SE)

Panel Size (mm)	Sheets per pack per Panel thickness (mm)										
	6	9	12	15	18	19	22	25	30	36	38
2440 × 1220	60	60	60	48	40	-	32	30	24	-	-
3050 × 1220	78	60	48	40	32	-	32	24	18	-	-

Panel products for every application

SterlingOSB® Zero Strength you can build on

Strong, consistent and great value, the SterlingOSB Zero range is ideal for structural applications.

- SterlingOSB Zero OSB3
- SterlingOSB Zero T&G
- SterlingOSB Zero StrongFix
- SterlingOSB Zero SiteCoat
- SterlingOSB Zero Fire Solutions

CaberBoard® Trusted flooring systems

Versatile flooring system for domestic and commercial floors, CaberBoard is stable, durable and easy to lay.

- CaberFloor P5
- CaberDek
- CaberShieldPlus
- CaberAcoustic
- CaberFix D4 (Adhesive)
- CaberFix D3 (Adhesive)
- CaberFix Joint&Joist (Adhesive)
- CaberFix Tape
- CaberFix X-Treme Tape

CaberWood MDF® Legendary performance

Engineered with consistent density for multiple use throughout the shop fitting, construction and furniture industries.

- CaberWood MDF Trade
- CaberWood MDF Trade MR
- CaberWood MDF Pro
- CaberWood MDF Pro MR
- CaberWood MDF Industrial

Application

Application	SterlingOSB Zero	CaberBoard	CaberWood MDF
Roofing	●		
Flooring	●	●	
Walling / Partitioning	●		
Timber frames	●	●	●
Hoarding / Fencing	●		
Shopfitting	●	●	●
Furniture	●		●
Other	●	●	●

*The above table provides general guidance only. It is recommended that you conduct small scale pilot tests to ensure you have the correct grade for your end use.

Roofing

Flat roof decking and pitched roof sarking



For sarking use SterlingOSB Zero OSB3 T&G. No knots or voids means reliable fixings across the board and the T&G profile helps increase the lifespan of the roof.

Roofing

Recommended product:

SterlingOSB® Zero® T&G

Specifically designed for flat roofing and pitched roofing, it is quick and easy to install, while ensuring full compliance to BS 6229:2003

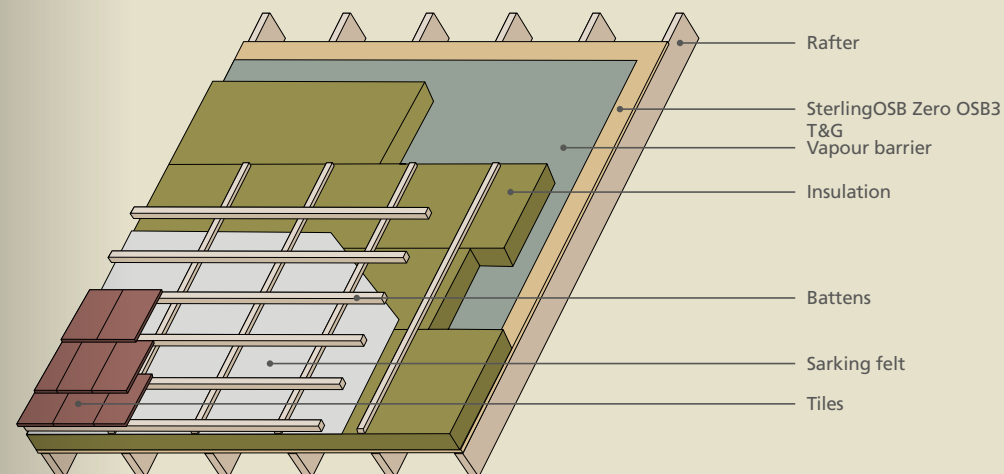

Roofing guidance

The following roofing specific advice should be noted:

Roofing

- Panels must be laid with the long edges at 90° to supports, and short edge joints must be staggered
- All short edges must be supported on joists or noggins
- Panel edges must bear approx. 20mm into joists
- Nailing must be at least 8mm from the panel edges
- The tongue and groove edge does not require to be continuously supported
- SterlingOSB Zero's smooth surface gives improved adhesion qualities for all flat roofing applications
- Fully BBA approved

Fixings

SterlingOSB Zero T&G should be fixed using approx. 3mm diameter ring-shank nails or screws, 50mm long at 100mm centres across the supporting joists.

Expansion gaps

It is well documented and strongly recommended that additional movement gaps are incorporated in large roof areas or long runs. An expansion provision should be allowed of 2mm per metre plus 1mm for every metre above 12m of the width or breadth of the area. On large roofs, a movement joint should be included every 12m approximately in either direction or at the particular requirement of the advising Structural Design Engineers / Architects. This movement joint should be approx. 25mm.

Ventilation

Design and applications of panels in flat roof decking is covered in section 2.5 of 'Panel Guide' issued by Wood Panel Industries Federation (WPIF).

Safety

As roof decking may be slippery when wet or covered with frost, snow, ice or sawdust, installers should wear rubber soled footwear. The use of a safety harness is recommended.

Coverings

A range of proprietary products may be used to cover SterlingOSB Zero T&G - refer to appropriate trade associations for guidance e.g. The National Federation of Roofing Contractors who can be contacted on 0207 638 7663.

Specification guidance

Further guidance on the selection and use of wood-based panels and other essential design information can be found in: WPIF Panel Guide, BS 6229, BBA Agrément Certificate No 01/3857 and DD ENV 12872:2000.

For further details please contact Norbord technical support or;

- www.wpif.org.uk
- www.bbacerts.co.uk

SterlingOSB Zero

For further product information, see page 08
For technical product information, see page 71



Flooring

New-build, replacement, domestic and commercial

Homes, schools, hospitals and offices.
No matter what size or shape of
floor you are laying, CaberBoard
is an advanced product range
designed to fit all applications.





Flooring

Recommended products:

CaberFloor P5®

CaberDek®

CaberShield+®

CaberAcoustic®

CaberFix®

High-strength flooring systems for domestic and commercial flooring, they are stable, durable and easy to lay while complying to BS EN 312.

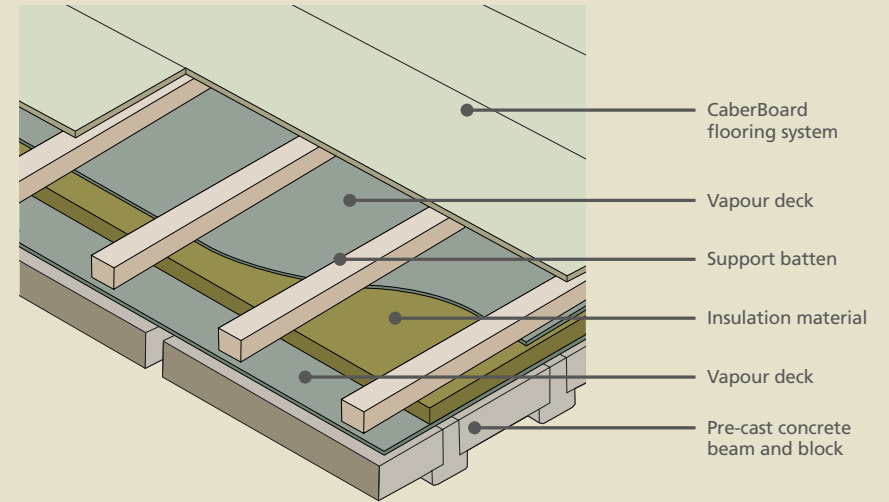

Best product for application

	CaberFloor P5	CaberFloor P5	CaberDek	CaberDek	CaberShieldPlus	CaberShieldPlus	CaberAcoustic	CaberAcoustic
Thickness (mm)	18	22	18	22	18	22	28	32
Dry Domestic	●	●	●	●	●	●	●	●
Domestic new build	●	●	●	●	●	●	●	●
Refurbishment	●	●	●	●	●	●	●	●
Commercial		●		●		●		●

CaberBoard
For further product information, see page 14
For technical product information, see page 82

Application*

*The above table provides general guidance only. For further advice contact technical.

Choose the most suitable flooring system

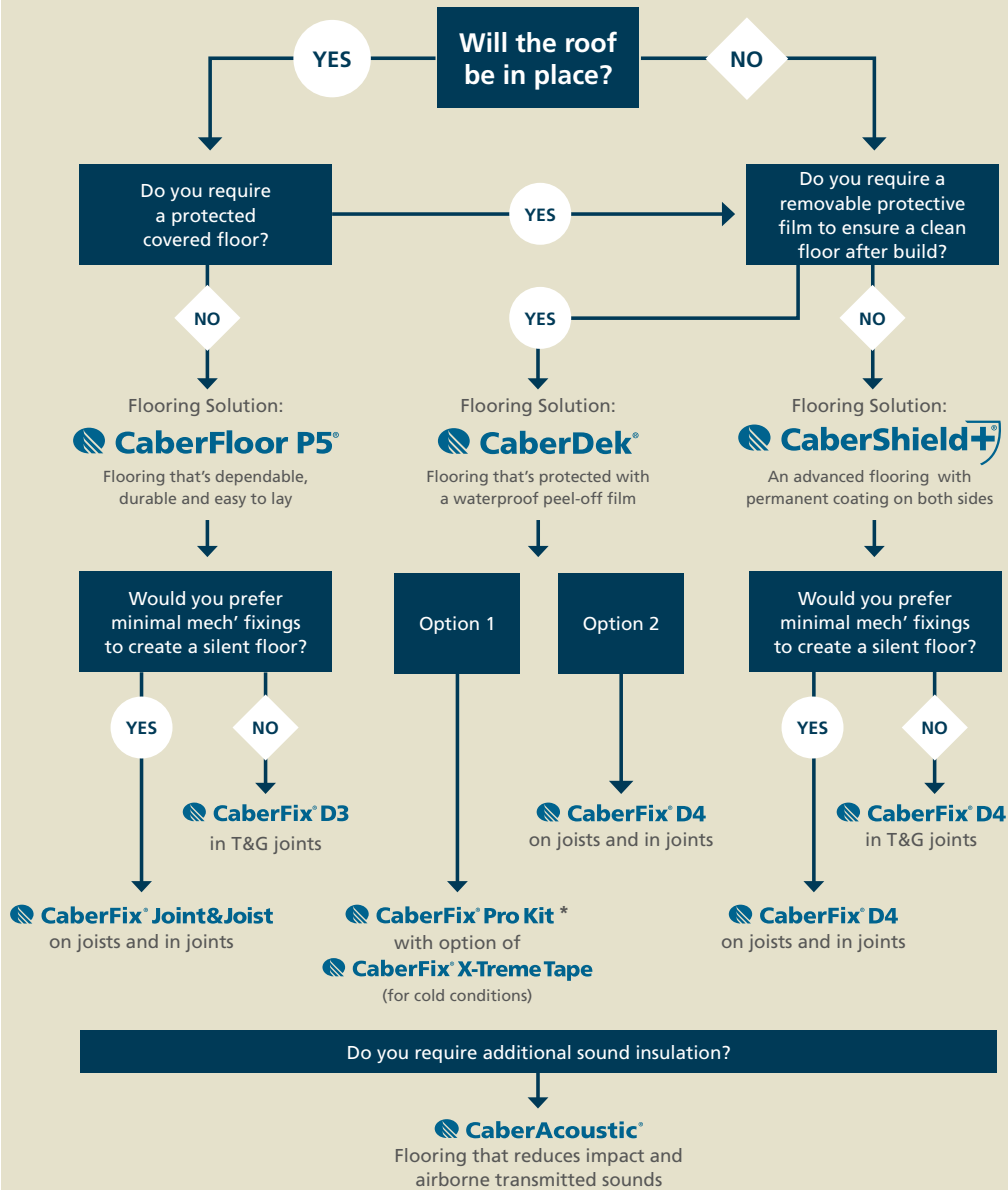

* CaberFix ProKit includes: 1 x CaberFix D3, 7 x CaberFix Joint&Joist, 3 x CaberFix Tape

CaberFloor P5 installation quick guide

Step 1. Adhesive I-joist application

- Apply one continuous bead of CaberFix Joint&Joist to the top of the joist or I-joist
- Use CaberFix Joint&Joist on joists and noggins in the area that is about to be directly laid
- Use a 6mm bead

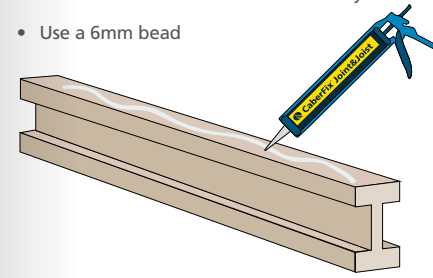

Step 2. Secret fixing & adhesive application

- Continue laying boards in a staggered format. Panels should be secretly screwed through the tongue at T&G joints at every joist
- Apply a 6mm bead of CaberFix Joint&Joist to T&G joints as shown

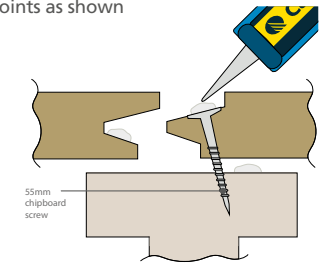

Step 3. Fixings per board / perimeter & sealing

- Fix perimeter as per diagram
- Leave minimum 10mm expansion gap at perimeter

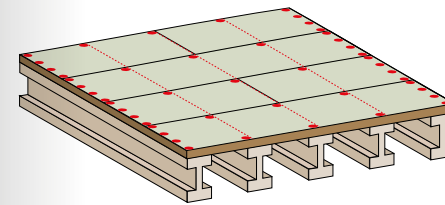

Floor fixing diagram (• Mechanical fixing positions)

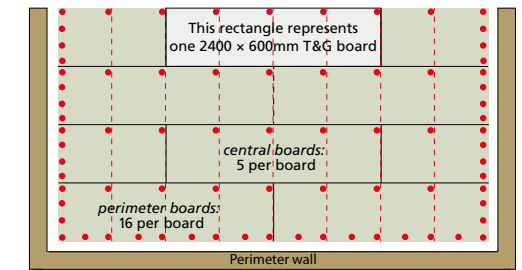

CaberFix® Joint&Joist

CaberFloor P5 is best used with CaberFix Joint&Joist, an adhesive and sealant that will adhere to a wide variety of materials, creating a strong, silent, and flexible bond.



- ✓ Provides strength, stability and flexibility when joining CaberBoard floors and joists
- ✓ Excellent resistance to temperature extremes
- ✓ Silent bonding layer between floors and joists
- ✓ Bonds in damp conditions to a variety of materials; 100% waterproof sealing

CaberDek installation quick guide

Step 1. Adhesive I-joist application

Apply one continuous ~6mm bead of CaberFix D4 adhesive to the top of the joist or I-joist. Use CaberFix D4 adhesive on joists and noggins in the area that is about to be directly laid.

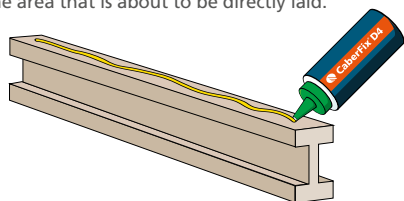

Step 2. Perimeter panel fixing

Panels should be fixed at perimeter, using annular ringshank nails or screws at 200–300mm centres. Fix flush or just below panel surface.

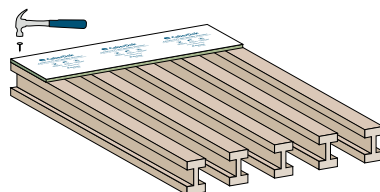

Step 3. Adhesive T&G application

A liberal application of CaberFix D4 adhesive should be made to both the tongue and groove of the profile joint of each panel to ensure that the entire joint is bonded. When the boards are pushed together a small amount of adhesive should squeeze out of the T&G, sufficient to cover any exposed chipboard on the joint.

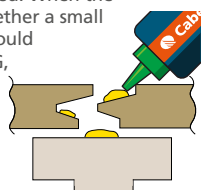

Step 4. Panel fixings

Continue laying boards in a staggered format. Panels may be secretly nailed through the tongue at T&G joints. For optimum performance we recommend a minimum of 5 mechanical fixings per 22 × 2400 × 600mm board when fitted at 600mm centres. i.e. 1 fixing per joist.

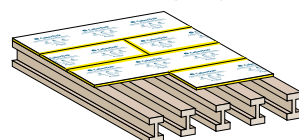

Step 5. Complete sealing

When installing CaberDek, any film that has peeled back from edges or T&G should be stuck back down using CaberFix D4 adhesive. For complete weather-tightness apply CaberFix D4 to exposed nail heads, cut edges and any exposed perimeter edges.

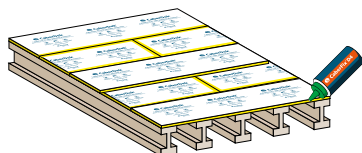

Step 6. Clean down

When all construction and decoration work is complete and the building is weather tight, the deck should be cleaned down: Remove the peel-off film by pulling slowly but firmly from the short end.

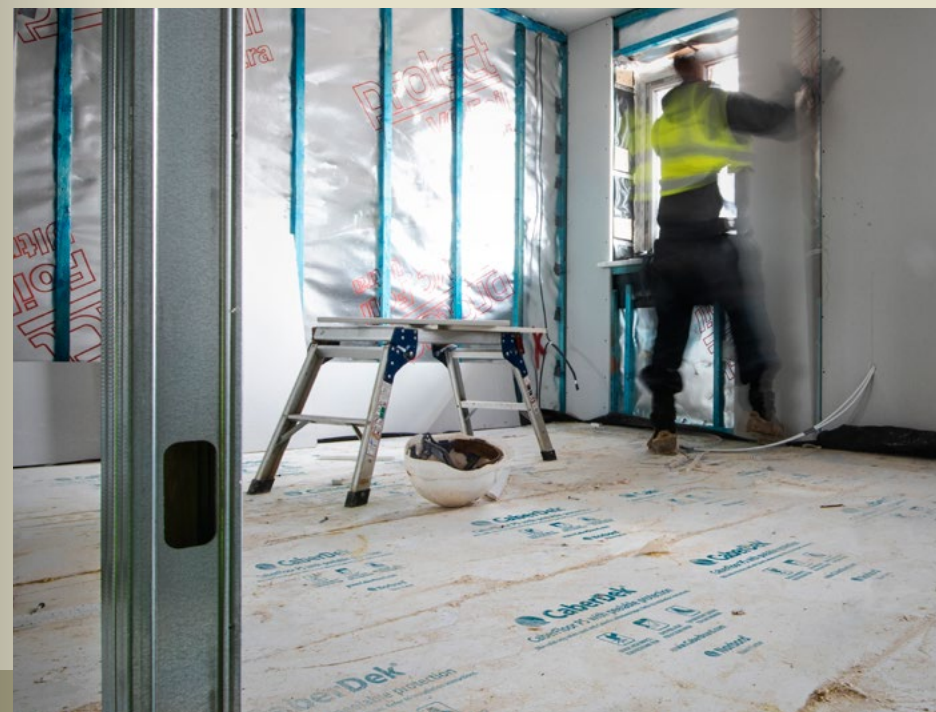
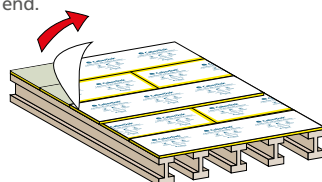

CaberDek is perfect for situations where flooring is laid before the building is weather tight and whilst there is still likelihood of construction mess.

CaberFix® D4



CaberDek and CaberShieldPlus are best used with CaberFix D4, an adhesive that bonds flooring to joists, T&G joints and seals exposed perimeter and edges to provide full BBA approval for up to 60 days exposure.

- Foaming adhesive – easy to see T&G joints are sealed
- BBA approved for up to 60 days exposure*
- One adhesive – making the job more efficient and cost-effective

*When installed according to manufacturer's instructions. 60 days weather exposure applies to use with CaberShieldPlus only

For detailed CaberBoard flooring installation advice, see page 84

CaberShieldPlus installation quick guide

Step 1. Adhesive I-joist application

Apply one continuous ~6mm bead of CaberFix D4 adhesive to the top of the joist or I-joist. Use CaberFix D4 adhesive on joists and noggins in the area that is about to be directly laid.

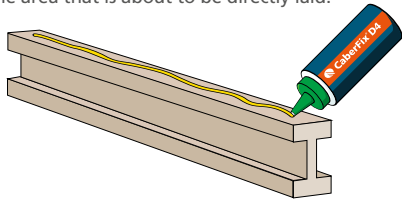

Step 2. Perimeter panel fixing

Panels should be fixed at perimeter, using annular ringshank nails or screws at 200–300mm centres. Fix flush or just below panel surface.

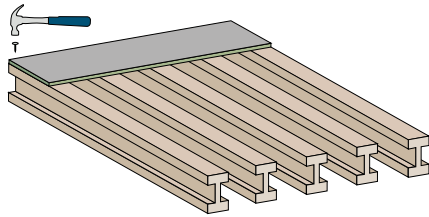

Step 3. Adhesive T&G application

A liberal application of CaberFix D4 adhesive should be made to both the tongue and groove of the profile joint of each panel to ensure that the entire joint is bonded. When boards are pushed together a small amount of adhesive should be squeezed out of the T&G. This seals the joint at the T&G.

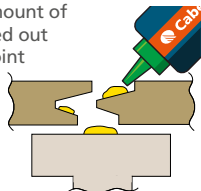

Step 4. Panel fixings

Continue laying boards in a staggered format. Panels may be secretly nailed through the tongue at T&G joints. For optimum performance we recommend a minimum of 5 mechanical fixings per 22 x 2400 x 600mm board when fitted at 600mm centres, i.e. 1 fixing per joist.

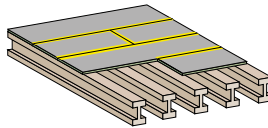

Step 5. Complete sealing

For complete weather-tightness apply CaberFix D4 to exposed nail heads, cut edges and any exposed perimeter edges.

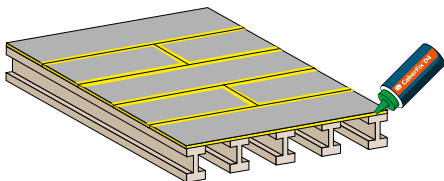

Step 6. Clean down

When all construction and decoration work is complete and the building is weather tight, the deck should be cleaned down. Once dry, any excess adhesive should be removed with a scraper.

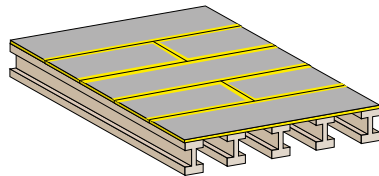

CaberAcoustic installation quick guide

Step 1. Deck preparation

Before laying CaberAcoustic on top of a timber floor, ensure all previous adhesives are set and the floor is cleaned down, level and dry. If laying on a concrete base, ensure a damp-proof membrane is used first.

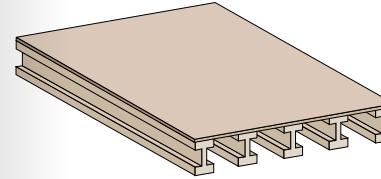

Step 2. Perimeter flanking

Place the flanking strip against the wall / perimeter of the floor – no fixings are required.

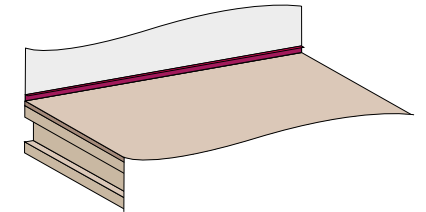

Step 3. Perimeter panel positioning

Lay the first CaberAcoustic panel (felt side down) and ensure the panel is pressed firmly against the flanking strip to create an airtight seal.

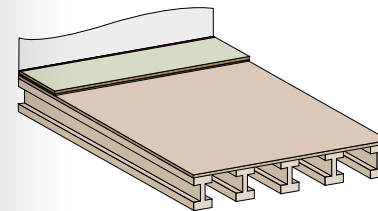

Step 4. T&G adhesive application

Continue to lay CaberAcoustic boards in a staggered format and apply a 6mm bead of CaberFix D3 to the T&G joints.

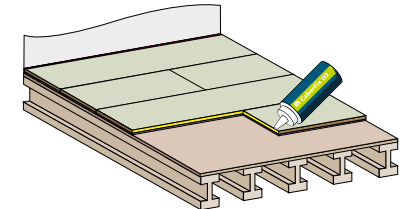

Step 5. Complete sealing

Ensure the floor is well sealed against air gaps. There must be no fastenings through the floating floor, with the only exception being where two panels join which have only cut edges, for example across a door opening.

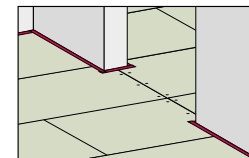



Forget about knots or voids spoiling your plans, SterlingOSB Zero lets you just get on with the job.

Walling / Partitioning
 Wall sheathing, partitioning and Structural Insulated Panels (SIPs)

Walling / Partitioning

Recommended products:

SterlingOSB® Zero® OSB3

SterlingOSB® Zero® StrongFix

Easy to saw, drill, nail, plane or file, SterlingOSB Zero is perfect for structural use in dry and humid conditions.

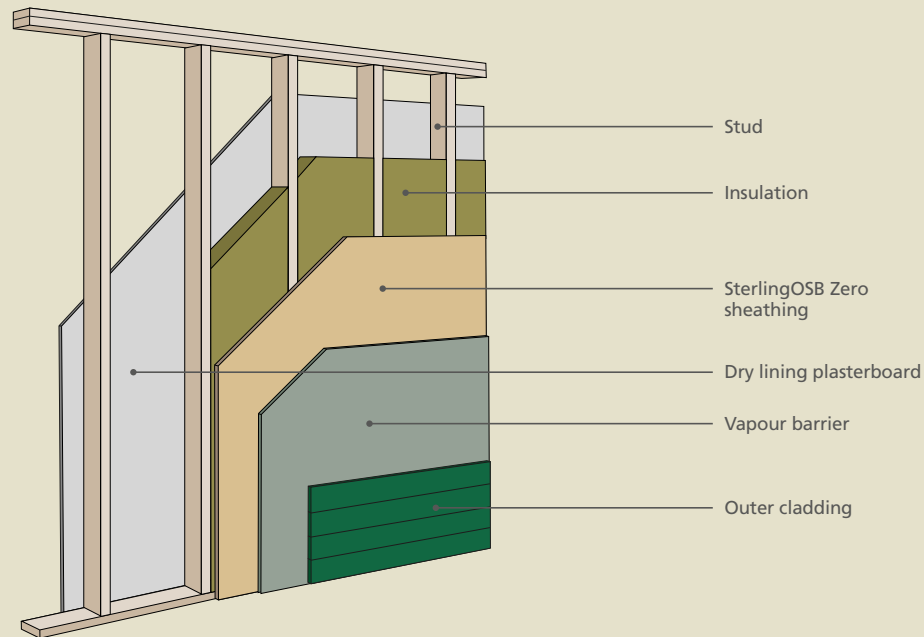

Application*

		SterlingOSB Zero OSB3	SterlingOSB Zero StrongFix
Dry conditions	Exhibition displays	●	●
	Interior decorative	●	●
	Internal hoarding	●	●
	Dry lining / Metal C-stud	●	●
Humid conditions	Wall sheathing	●	●
	Partitioning	●	●
	Agricultural buildings	●	●
	Portable buildings / Caravans	●	●

SterlingOSB Zero
For further product information, see page 08
For technical product information, see page 71
For installation guidance, see page 77 and 78

Walling guidance

The following walling specific advice should be noted:

Fixings

- Panels must be laid with the long edges at 90° to supports and short edge joints must be staggered
- All short edges must be supported on studs or noggins
- Panel edges must bear approx. 18mm onto joists
- Nailing must be at least 8mm from the panel edges
- Panels should be fixed using approx. 3mm ring-shank nails or screws whose length is 2.5 times the thickness of the panel

Expansion gaps

With all square edged panels a 3mm expansion gap should be allowed between boards and edges.

Spans & nailing centres	Sheathing
Thickness (mm)	9 mm
Max. span* (domestic)	610 mm
Nail centres (edges)	150 mm
Nail centres (intermediate)	300 mm
Weight (approx.)	3.5 kg/m ²
Face smooth nail retention**	158 N
Edge screw retention	-
Face screw retention	625 N

*The above table provides general guidance only. It is recommended that you conduct small scale pilot tests to ensure you have the correct grade for your end use.

Roofing
Flooring
Walling
Product application guide

Walling
Timber frames
Hoarding
Shopfitting
Furniture
Other
Technical
Customer support

Timber Frames

All aspects of a house build; structural, flooring, interiors



High grade boards speed up construction because minimal finishing is required.

Roofing
Flooring
walling
Product application guide

Timber frames
Hoarding
Shopfitting
Furniture
Other
Technical
Customer support

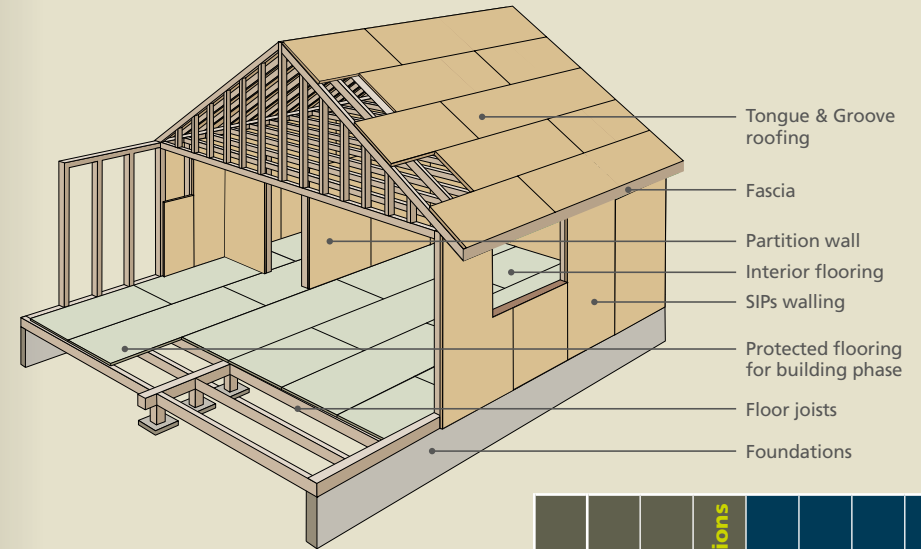

SterlingOSB Zero and CaberBoard include a wide range of grades specifically designed for structural use and with unique properties to speed up the construction phase.

Application*

	SterlingOSB Zero OSB3	SterlingOSB Zero T&G	SterlingOSB Zero StrongFix	SterlingOSB Zero Fire Solutions	CaberFloor P5	CaberDek	CaberShieldPlus	CaberAcoustic
Wall sheathing (humid conditions)	●							
Internal hoarding / decorative (dry conditions)	●							
Dry lining / Metal C-stud			●					
Roofing (pitched and flat)		●						
Fire reduction during construction phase				●				
Domestic flooring (dry conditions)		●			●	●	●	●
Domestic flooring (clean finish in exposed conditions)						●		
Domestic flooring (exposed construction phase)						●	●	

*The above table provides general guidance only. It is recommended that you conduct small scale pilot tests to ensure you have the correct grade for your end use. CaberAcoustic is an overlay board.

SterlingOSB Zero
For further product information, see page 08
For technical product information, see page 71

CaberBoard
For further product information, see page 14
For technical product information, see page 82

Timber Frames

Recommended products:

 SterlingOSB® Zero® OSB3

 SterlingOSB® Zero® T&G

 SterlingOSB® Zero® StrongFix

 SterlingOSB® Zero® Fire Solutions

 CaberFloor P5®

 CaberDek®

 CaberShield+®

 CaberAcoustic®

 CaberFix®

Hoarding / Fencing

Billboard construction and site hoarding



The pre-prepared surface makes paint and graphics easy to apply and the quality finish gives a professional appearance to sites.

Hoarding / Fencing

Recommended products:

SterlingOSB® Zero SiteCoat

Designed specifically for site hoarding and barrier fencing, SterlingOSB Zero SiteCoat has a primed and smooth surface ready for the quick and easy application of paint or marketing graphics.

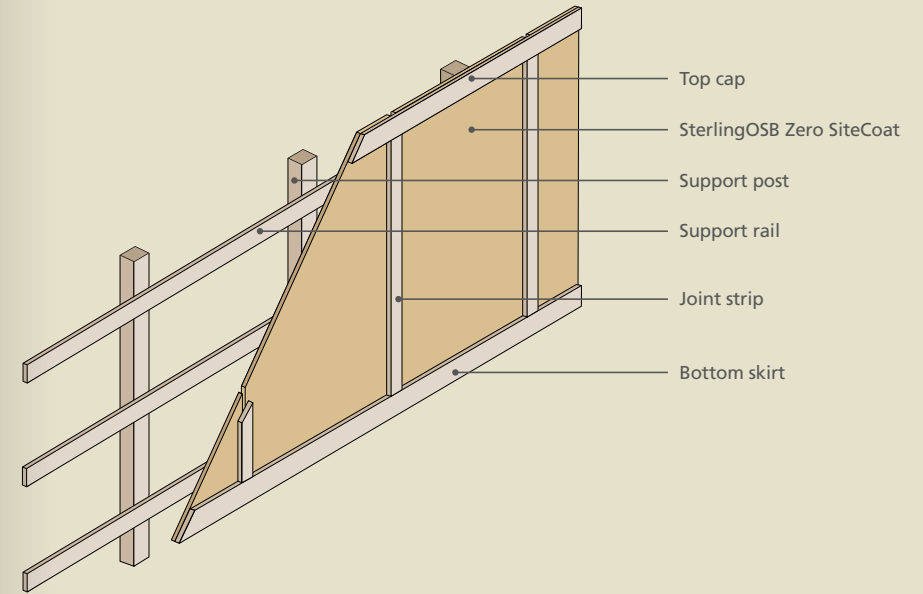

Application*

	SterlingOSB Zero SiteCoat
Site hoarding	●
Fencing	●

Features and benefits

- SterlingOSB Zero SiteCoat square-edged panel; factory primed with eco-friendly non-solvent coating that fills and smooths the surface
- Ready for painting, it reduces on-site finishing costs
- Standard fixing methods & woodworking benefits of SterlingOSB Zero
- Made in the UK from responsibly sourced timber
- Low carbon footprint
- Plus all the inherent benefits of SterlingOSB Zero - no knots or voids

SterlingOSB Zero

For further product information, see page 08
For technical product information, see page 71

*The above table provides general guidance only. It is recommended that you conduct small scale pilot tests to ensure you have the correct grade for your end use.

Hoarding erection guidance

System A

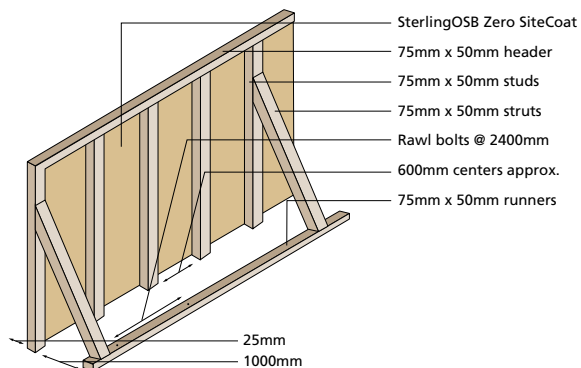

System B

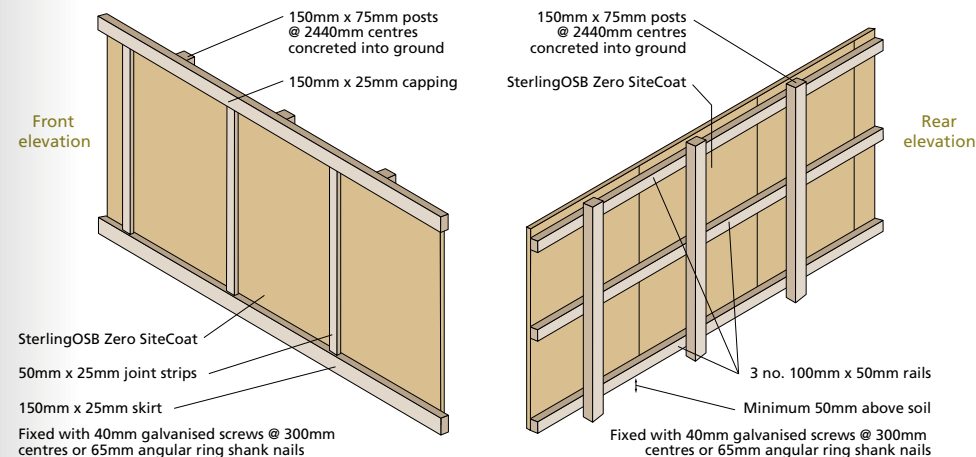

Hoarding guidance

The following hoarding specific advice should be noted:

Fixings

A typical installation method is a post and rail design. This is comprised of three (minimum) or four horizontal rails secured to posts with the panels being fixed to the rails.

- Panels should be fixed to the frame with 50mm galvanised screws with a recommended spacing of 200mm / 300mm centres
- Panels must be fitted with a minimum clearance of 50mm from ground level. Any site ponding should be avoided

Expansion gaps

On a run of hoarding, a 3mm expansion gap is recommended between panels.

- A minimum expansion gap of 10mm is recommended where the hoarding panels abut solid surfaces (existing structures / walls)
- Expansion joints should be filled with flexible joint filler such as CaberFix Joint&Joist to give the best finish and offer additional protection to the panel edge

Finishing

We highly recommend the use of top capping and bottom skirting in the design application of the hoarding. Utmost care should be taken when fitting these sections to ensure no damage is made to panel edges.

All fixing heads and bruised panels should be filled with good quality wood filler that is then lightly sanded prior to the panel being painted.













Shopfitting

Displays, counters, boxing in, flooring and wall partitions

Achieving high quality results against a deadline is of paramount importance, and premium grade products ensure a precision finish every time.

Shopfitting

Recommended products:

-  **CaberWood MDF® Trade**
-  **CaberWood MDF® Trade MR**
-  **CaberWood MDF® Pro**
-  **CaberWood MDF® Pro MR**
-  **CaberWood MDF® Industrial**
-  **CaberFloor P5®**
-  **CaberDek®**
-  **CaberShield+®**
-  **CaberAcoustic®**
-  **CaberFix®**
-  **SterlingOSB® Zero® OSB3**
-  **SterlingOSB® Zero® T&G**

CaberWood MDF, CaberBoard and SterlingOSB Zero include a wide range of grades to suit commercial applications where timing and quality are primary factors.

Best product for application

	CaberWood MDF Trade	CaberWood MDF Trade MR	CaberWood MDF Pro	CaberWood MDF Pro MR	CaberWood MDF Industrial	CaberFloor P5	CaberDek	CaberShieldPlus	CaberAcoustic	SterlingOSB Zero OSB3	SterlingOSB Zero T&G
Thickness range (mm)**	12-25	12-25	6-38	6-30	15-25	22	22	22	32	9-22	9-22
General purpose joinery	●	●	●	●	●						
Simple designs with minimal profiles			●	●	●					●	●
Humid conditions		●		●	●					●	●
Deep routed profiles					●						
Advanced, deep routed profiles and painted finishes					●						
Architectural mouldings; skirting and architraves			●	●	●						
Commercial flooring						●	●	●	●		

Application*

CaberWood MDF
For further product information, see page 22
For technical product information, see page 94

CaberBoard
For further product information, see page 14
For technical product information, see page 82

* The above table provides general guidance only. It is recommended that you conduct small scale pilot tests to ensure you have the correct grade for your end use.
** Other thicknesses are available on request.



Consistent density and FSC® certified are essential qualities in the furniture industry.

Furniture

High volume production of domestic and commercial furniture



CaberWood MDF and SterlingOSB Zero are some of the most popular materials in the furniture industry. With their consistent density providing an ease and speed of workability, they form the backbone and fascias of a huge variety of items.

Furniture

Recommended products:

 **CaberWood MDF® Trade**

 **CaberWood MDF® Trade MR**

 **CaberWood MDF® Pro**

 **CaberWood MDF® Pro MR**

 **CaberWood MDF® Industrial**

 **SterlingOSB® Zero OSB3**

Best product for application

Application*	CaberWood MDF Trade	CaberWood MDF Trade MR	CaberWood MDF Pro	CaberWood MDF Pro MR	CaberWood MDF Industrial	SterlingOSB Zero OSB3
Chairs, tables, cabinets	●	●	●	●	●	●
Bed frames	●		●		●	●
Kitchen and bathroom furniture		●		●	●	●
Wardrobes	●		●		●	●
Shelving			●	●	●	●
Couch frames						●

CaberWood MDF
For further product information, see page 22
For technical product information, see page 94

SterlingOSB Zero
For further product information, see page 08
For technical product information, see page 71

* The above table provides general guidance only. It is recommended that you conduct small scale pilot tests to ensure you have the correct grade for your end use.



Other
Moulding and packaging



Highly durable and exempt from phytosanitary regulation, SterlingOSB Zero is perfect for international shipping crates.

With such a consistent density, machines can be easily set-up for complex routs and profiling.

Though individually unique, CaberWood MDF and SterlingOSB Zero both share the common benefit of consistent density, making tool set-up simple and finishing time minimal.

Moulding and packaging

Recommended products:

 **CaberWood MDF® Trade**

 **CaberWood MDF® Trade MR**

 **CaberWood MDF® Pro**

 **CaberWood MDF® Pro MR**

 **CaberWood MDF® Industrial**

 **SterlingOSB® Zero® OSB3**

Best product for application

Application*	CaberWood MDF Trade	CaberWood MDF Trade MR	CaberWood MDF Pro	CaberWood MDF Pro MR	CaberWood MDF Industrial	SterlingOSB Zero OSB3
Fire surrounds			●	●	●	
Staircases			●	●	●	
Wall panelling		●	●	●	●	
Doors			●	●	●	
Architectural moulding			●	●	●	
Packaging						●
Pallets / crates						●

CaberWood MDF
For further product information, see page 22
For technical product information, see page 94

SterlingOSB Zero
For further product information, see page 08
For technical product information, see page 71



* The above table provides general guidance only. It is recommended that you conduct small scale pilot tests to ensure you have the correct grade for your end use.

TECHNICAL INFORMATION

At Norbord, our experienced technical team is on hand to deal with enquiries from architects, builders, contractors – in fact anyone involved in the specification or use of Norbord's engineered wood-based panels.

MSDS

Material Safety Data-Sheets are available for all Norbord products. Please contact Norbord Technical Support or visit:

www.norbord.co.uk

Technical Support

For specialist product advice:

SterlingOSB Zero

Steve McTaggart
T: 01463 791 764

CaberBoard CaberWood MDF

Alan Kirkpatrick
T: 01786 819 205

General Enquiries

For general Norbord information:

T: 01786 819 225

SterlingOSB Zero technical data

Product specification

Property	EN Standard	Unit	Specification
Tolerance on the mean density within a board	323	mm	±15%
Length / Width Deviation	324-1	mm	±3
Thickness Deviation – unsanded	324-1	mm	±0.8
Thickness Deviation – sanded	324-1	mm	±0.3
Squareness – tolerance	324-2	mm/m	2
Straightness	324-2	mm/m	1.5
Linear Expansion (65%- 85% relative humidity)		%	0.15
Thermal Conductivity 'K' Value	13986	w/(m.k)	0.13
Reaction to Fire (BS EN 135 01-1)	13986		D
Formaldehyde	120	mg/100g	<8

Load bearing for use in humid conditions:

Requirements for specified mechanical & swelling properties

Property	EN Standard	Unit	OSB3 Requirement		
			6–10 mm	>10 to <18	18–25 mm
Moisture Content	322	%	2-12	2-12	2-12
Bending Strength – major axis	310	N/mm ²	22	20	18
Bending Strength – minor axis	310	N/mm ²	11	10	9
Modulus of Elasticity in bending – major axis	310	N/mm ²	3500	3500	3500
Modulus of Elasticity in bending – minor axis	310	N/mm ²	1400	1400	1400
Internal Bond (IB)	319	N/mm ²	0.34	0.32	0.30
Thickness Swelling (24hr immersion)	317	%	15	15	15
Bending Strength after cyclic test – major axis	321+ 310	N/mm ²	9	8	7

Product sizes available

Product	Size (mm)	Thickness (mm)
SterlingOSB Zero OSB3 – Square Edged	2400 × 1200	9, 11, 15, 18
	2440 × 1220	9, 11, 15, 18
	2700 × 1200	9
SterlingOSB Zero OSB3 Tongue & Groove – 2 edges	2400 × 1200	18, 22
	2440 × 1220	18, 22
SterlingOSB Zero OSB3 Tongue & Groove – 4 edges	2400 × 590	18
	2440 × 590	18

Other sizes are available on request.

Boards per pack

Thickness	9	11	14	15	18	22
Number of boards	100	82	60	60	50	40

SterlingOSB Zero technical data *continued*

Characteristic values of boards complying with BS EN 300:

OSB3: Load bearing boards for use in humid conditions

This gives information on the characteristic values of both mechanical properties and density for those wood based panels the values of which, unless specified to the contrary, have been determined using the sampling techniques set out in BS EN 1058 and the testing procedures given in BS EN 789. The minimum characteristic values for OSB complying with BS EN 300.

When OSB3 is used structurally under service class 1 conditions, the characteristic values of the mechanical properties and density given in the tables below will apply. These require to be modified according to EC5 for duration of load (k_{mod} , k_{def}).

When OSB3 is used structurally under service class 2 conditions, the characteristic values of the mechanical properties and density given in Table 1 shall be modified according to EC5 for both service class and duration of load (k_{mod} , k_{def}).

Characteristic density (kg/m³) and strength (N/mm²) values

Thickness (mm)	Density	Bending		Tension		Compression		Panel Shear	Planar Shear
		f_m	$f_{m,90}$	f_t	$f_{t,90}$	f_c	$f_{c,90}$		
t_{nom}	ρ	0	90	0	90	0	90	f_v	f_r
> 6 to 10	550	18.0	9.0	9.9	7.2	15.9	12.9	6.8	1.0
> 10 to 18	550	16.4	8.2	9.4	7.0	15.4	12.7	6.8	1.0
> 18 to 25	550	14.8	7.4	9.0	6.8	14.8	12.4	6.8	1.0

Mean stiffness values (N/mm²)

Thickness (mm)	Bending		Tension		Compression		Panel Shear	Planar Shear
	E_m	$E_{m,90}$	E_t	$E_{t,90}$	E_c	$E_{c,90}$		
t_{nom}	0	90	0	90	0	90	G_v	G_r
> 6 to 10	4930	1980	3800	3000	3800	3000	1080	50
> 10 to 18	4930	1980	3800	3000	3800	3000	1080	50
> 18 to 25	4930	1980	3800	3000	3800	3000	1080	50

The 5% characteristic values for stiffness should be taken as 0.85 times the mean values given in the tables above. Other properties not given in the tables shall comply with the requirements given in BS EN 300 for the grades OSB/2 or OSB/3.

Permissible Vertical Loads

Design vertical point (line) and uniformly distributed loads (UDL), per board thickness, per given span – spanning longitudinally, based on:

1. Material properties to BS EN 12369-1:2001 and BS EN 300:2006.
2. Structural design to Eurocode 5 (BS EN 1995-1-1:2004+A2:2014).
3. Performance characteristics as floors and roofs to BS EN 12871:2013.

Service Classes

Three service classes are defined in Eurocode 5.

Service Class 1

Characterised by a moisture content in the materials corresponding to a temperature of 20°C and the relative humidity of the surrounding air only exceeding 65% for a few weeks per year.

Service Class 2

Characterised by a moisture content in the materials corresponding to a temperature of 20°C and the relative humidity of the surrounding air only exceeding 85% for a few weeks per year.

Service Class 3

Climatic conditions leading to higher moisture contents than in Service Class 2.

Load Duration Class

Load Duration Class	Order of accumulated duration of characteristic load	Examples of loading
Permanent	More than 10 years	Self weight
Long-term	6 months to 10 years	Storage
Medium-term	1 week to 6 months	Imposed load
Short-term	Less than on week	Snow* and wind
Instantaneous		Accidental load

*In areas which have a heavy snow load for a prolonged period of time, part of the load should be regarded as medium-term

Notes:

1. The design (permissible) loads per span values given in the tables overleaf (1 and 2) are based on the modification factors detailed in Eurocode 5, BS EN 1995-1-1:2004+A2:2014 as well as the requirements of BS EN 12871:2013 and the load factor for variable actions $\gamma_Q = 1.35$, under Service Classes 1 and 2 conditions for long-term and medium-term loadings.
2. Point (line) loads are in kN.
3. Uniformly distributed loads are in kN/m².
4. Design load values are given for multi-span (i.e. boards continuous over 3 or more supports) cases.
5. Permissible deflection is considered as: 1/150th of span.
6. The design load, for a particular board / span / service condition / load duration, may be considered as the smaller value of its 'strength limit' and the 'deflection limit'.

Note: In accordance with the National Forward to BS EN 12871:2013, no codified deflection limit for panels spanning between joists is specified in the UK. Therefore, if deflection is not a design criterion, then the structural engineer may consider the strength values given in the tables overleaf as the limiting design (permissible) loads.

7. The information and design load values are for guidance only and the liability is excluded.

Table 1: **Multi-span (3 point support) – Uniformly distributed load (Eurocode 5)**
(a) Service Class 1

Span (mm)	Design limit	SterlingOSB Zero OSB3 thickness (mm) and Load Duration									
		9		11		15		18		22	
		Long	Med	Long	Med	Long	Med	Long	Med	Long	Med
300	Strength	6.67	9.33	9.07	12.7	16.87	23.62	21.93	30.7	32.75	45.85
	Deflection	1.63	2.28	2.98	4.17	7.56	10.58	13.06	18.28	23.84	33.37
350	Strength	4.9	6.86	6.67	9.33	12.4	17.35	16.11	22.55	24.06	33.69
	Deflection	1.03	1.44	1.88	2.63	4.76	6.66	8.22	11.51	15.01	21.02
400	Strength	3.75	5.25	5.1	7.15	9.49	13.29	12.33	17.27	18.42	25.79
	Deflection	0.69	0.96	1.26	1.76	3.19	6.66	5.51	7.71	10.06	14.08
450	Strength	2.96	4.15	4.03	5.65	7.5	10.5	9.74	13.64	14.56	20.38
	Deflection	0.48	0.68	0.88	1.24	2.24	3.13	3.87	5.42	7.06	9.89
500	Strength	2.4	3.36	3.27	4.57	6.07	8.5	7.89	11.05	11.79	16.51
	Deflection	0.35	0.49	0.64	0.9	1.63	2.28	2.82	3.95	5.15	7.21
550	Strength	1.98	2.78	2.7	3.78	5.02	7.03	6.52	9.13	9.74	13.64
	Deflection	0.26	0.37	0.48	0.68	1.23	1.72	2.12	2.97	3.87	5.42
600	Strength	1.67	2.33	2.27	3.18	4.22	5.91	5.48	7.67	8.19	11.46
	Deflection	0.2	0.29	0.37	0.52	0.94	1.32	1.63	2.28	2.98	4.17
650	Strength	1.42	1.99	1.93	2.71	3.59	5.03	4.67	6.54	6.98	9.77
	Deflection	0.16	0.22	0.29	0.41	0.74	1.04	1.28	1.8	2.34	3.28
700	Strength	1.22	1.71	1.67	2.33	3.1	4.34	4.03	5.64	6.02	8.42
	Deflection	0.13	0.18	0.23	0.33	0.59	0.83	1.03	1.44	1.88	2.63
750	Strength	1.07	1.49	1.45	2.03	2.7	3.78	3.51	4.91	5.24	7.34
	Deflection	0.1	0.15	0.19	0.27	0.48	0.68	0.84	1.17	1.53	2.14
800	Strength	0.94	1.31	1.28	1.79	2.37	3.32	3.08	4.32	4.61	6.45
	Deflection	0.09	0.12	0.16	0.22	0.4	0.56	0.69	0.96	1.26	1.76

(b) Service Class 2

300	Strength	5.33	7.33	7.26	9.98	13.5	18.56	17.54	24.12	26.2	36.03
	Deflection	1.13	1.55	2.06	2.84	5.23	7.2	9.04	12.43	16.51	22.7
350	Strength	3.92	5.39	5.33	7.33	9.92	13.64	12.89	17.72	19.25	26.47
	Deflection	0.71	0.98	1.3	1.79	3.3	4.53	5.69	7.83	10.4	14.3
400	Strength	3	4.13	4.08	5.61	7.59	10.44	9.87	13.57	14.74	20.27
	Deflection	0.48	0.66	0.87	1.2	2.21	4.53	3.81	5.25	6.96	9.58
450	Strength	2.37	3.26	3.23	4.44	6	8.25	7.8	10.72	11.65	16.01
	Deflection	0.33	0.46	0.61	0.84	1.55	2.13	2.68	3.68	4.89	6.73
500	Strength	1.92	2.64	2.61	3.59	4.86	6.68	6.31	8.68	9.43	12.97
	Deflection	0.24	0.34	0.45	0.61	1.13	1.55	1.95	2.69	3.57	4.9
550	Strength	1.59	2.18	2.16	2.97	4.02	5.52	5.22	7.18	7.8	10.72
	Deflection	0.18	0.25	0.33	0.46	0.85	1.17	1.47	2.02	2.68	3.68
600	Strength	1.33	1.83	1.81	2.5	3.37	4.64	4.39	6.03	6.55	9.01
	Deflection	0.14	0.19	0.26	0.35	0.65	0.9	1.13	1.55	2.06	2.84
650	Strength	1.14	1.56	1.55	2.13	2.88	3.95	3.74	5.14	5.58	7.67
	Deflection	0.11	0.15	0.2	0.28	0.51	0.71	0.89	1.22	1.62	2.23
700	Strength	0.98	1.35	1.33	1.83	2.48	3.41	3.22	4.43	4.81	6.62
	Deflection	0.09	0.12	0.16	0.22	0.41	0.57	0.71	0.98	1.3	1.79
750	Strength	0.85	1.17	1.16	1.6	2.16	2.97	2.81	3.86	4.19	5.76
	Deflection	0.07	0.1	0.13	0.18	0.33	0.46	0.58	0.8	1.06	1.45
800	Strength	0.75	1.03	1.02	1.4	1.9	2.61	2.47	3.39	3.68	5.07
	Deflection	0.06	0.08	0.11	0.15	0.28	0.38	0.48	0.66	0.87	1.2

Table 2: **Multi-span (3 point support) – Point (line) load (Eurocode 5)**
(a) Service Class 1

Span (mm)	Design limit	SterlingOSB Zero OSB3 thickness (mm) and Load Duration									
		9		11		15		18		22	
		Long	Med	Long	Med	Long	Med	Long	Med	Long	Med
300	Strength	1	1.4	1.36	1.91	2.53	3.54	3.29	4.6	4.91	6.88
	Deflection	0.31	0.43	0.56	0.78	1.42	1.98	2.45	3.43	4.47	6.26
350	Strength	0.86	1.2	1.17	1.63	2.17	3.04	2.82	3.95	4.21	5.9
	Deflection	0.22	0.31	0.41	0.57	1.04	1.46	1.8	2.52	3.28	4.6
400	Strength	0.75	1.05	1.02	1.43	1.9	2.66	2.47	3.45	3.68	5.16
	Deflection	0.17	0.24	0.31	0.44	0.8	1.67	1.38	1.93	2.51	3.52
450	Strength	0.67	0.93	0.91	1.27	1.69	2.36	2.19	3.07	3.28	4.59
	Deflection	0.14	0.19	0.25	0.35	0.63	0.88	1.09	1.52	1.99	2.78
500	Strength	0.6	0.84	0.82	1.14	1.52	2.13	1.97	2.76	2.95	4.13
	Deflection	0.11	0.15	0.2	0.28	0.51	0.71	0.88	1.23	1.61	2.25
550	Strength	0.55	0.76	0.74	1.04	1.38	1.93	1.79	2.51	2.68	3.75
	Deflection	0.09	0.13	0.17	0.23	0.42	0.59	0.73	1.02	1.33	1.86
600	Strength	0.5	0.7	0.68	0.95	1.27	1.77	1.64	2.3	2.46	3.44
	Deflection	0.08	0.11	0.14	0.2	0.35	0.5	0.61	0.86	1.12	1.56
650	Strength	0.46	0.65	0.63	0.88	1.17	1.64	1.52	2.13	2.27	3.17
	Deflection	0.07	0.09	0.12	0.17	0.3	0.42	0.52	0.73	0.95	1.33
700	Strength	0.43	0.6	0.58	0.82	1.08	1.52	1.41	1.97	2.11	2.95
	Deflection	0.06	0.08	0.1	0.14	0.26	0.36	0.45	0.63	0.82	1.15
750	Strength	0.4	0.56	0.54	0.76	1.01	1.42	1.32	1.84	1.97	2.75
	Deflection	0.05	0.07	0.09	0.13	0.23	0.32	0.39	0.55	0.72	1
800	Strength	0.38	0.53	0.51	0.71	0.95	1.33	1.23	1.73	1.84	2.58
	Deflection	0.04	0.06	0.08	0.11	0.2	0.28	0.34	0.48	0.63	0.88

(b) Service Class 2

300	Strength	0.8	1.1	1.09	1.5	2.02	2.78	2.63	3.62	3.93	5.4
	Deflection	0.21	0.29	0.39	0.53	0.98	1.35	1.7	2.33	3.1	4.26
350	Strength	0.69	0.94	0.93	1.28	1.74	2.39	2.26	3.1	3.37	4.63
	Deflection	0.16	0.21	0.28	0.39	0.72	0.99	1.25	1.71	2.27	3.13
400	Strength	0.6	0.83	0.82	1.12	1.52	2.09	1.97	2.71	2.95	4.05
	Deflection	0.12	0.16	0.22	0.3	0.55	1.13	0.95	1.31	1.74	2.39
450	Strength	0.53	0.73	0.73	1	1.35	1.86	1.75	2.41	2.62	3.6
	Deflection	0.09	0.13	0.17	0.24	0.44	0.6	0.75	1.04	1.38	1.89
500	Strength	0.48	0.66	0.65	0.9	1.21	1.67	1.58	2.17	2.36	3.24
	Deflection	0.08	0.1	0.14	0.19	0.35	0.49	0.61	0.84	1.11	1.53
550	Strength	0.44	0.6	0.59	0.82	1.1	1.52	1.44	1.97	2.14	2.95
	Deflection	0.06	0.09	0.12	0.16	0.29	0.4	0.5	0.69	0.92	1.27
600	Strength	0.4	0.55	0.54	0.75	1.01	1.39	1.32	1.81	1.97	2.7
	Deflection	0.05	0.07	0.1	0.13	0.25	0.34	0.42	0.58	0.77	1.06
650	Strength	0.37	0.51	0.5	0.69	0.93	1.28	1.21	1.67	1.81	2.49
	Deflection	0.05	0.06	0.08	0.11	0.21	0.29	0.36	0.5	0.66	0.91
700	Strength	0.34	0.47	0.47	0.64	0.87	1.19	1.13	1.55	1.68	2.32
	Deflection	0.04	0.05	0.07	0.1	0.18	0.25	0.31	0.43	0.57	0.78
750	Strength	0.32	0.44	0.44	0.6	0.81	1.11	1.05	1.45	1.57	2.16
	Deflection	0.03	0.05	0.06	0.09	0.16	0.22	0.27	0.37	0.5	0.68
800	Strength	0.3	0.41	0.41	0.56	0.76	1.04	0.99	1.36	1.47	2.03
	Deflection	0.03	0.04	0.05	0.07	0.14	0.19	0.24	0.33	0.44	0.6

SterlingOSB Zero storage and conditioning

Storage

Panels should be banded and stored under cover, on a level base with sufficient bearers to prevent sagging or other distortion. Care should be taken to protect edges. Where the panel is to be stored for a prolonged period, additional bearers should be installed.

An HSE information sheet on the 'safe stacking of sawn material and board materials' is available in our document library at www.norbord.co.uk

Conditioning

In common with other wood and wood-based products, OSB may expand or contract slightly when exposed to changes of moisture in the atmosphere. Boards should be allowed to reach equilibrium by storing them under the atmospheric conditions in which they are to be used for a minimum of 48 hours prior to installation.

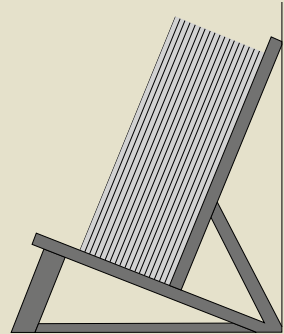

Correct method of edge stacking

Coating

When choosing a coating system, the desired longevity, decorative effect and level of maintenance should be considered.

Priming and top coating with a spirit based coating, as directed by the manufacturers, will give the highest quality finish. Where the final appearance is less important, water-based products may be used. These may cause some slight swelling of the surface wafers emphasising their outline.

Small test areas are recommended as Norbord Europe Ltd cannot be held responsible for other manufacturers' product claims in this respect. Manufacturers' guidelines on application should always be followed.

Treating

If required, SterlingOSB Zero can be treated to further protect against fungal or insect attack. It is recommended that a 3-minute dip cycle rather than a double vacuum cycle be used, and a solvent-based

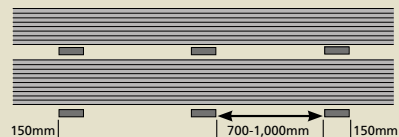

Correct method of storage on bearers

system should be used in preference to a water-based system. Experience shows that adequate preservative uptake is provided by this method.

Double vacuum systems and the use of water based chemicals can, as with most panel products, adversely affect the structural properties of the panel. All fire retardant impregnation systems are water based and usually involve a double vacuum and pressure cycle. It is essential to obtain structural performance characteristics from the treatment company and follow their end use recommendations. Fire-retardant paints and finishes can be used on SterlingOSB Zero. Visit www.trada.co.uk for up to date information.

Norbord Europe Ltd cannot be held responsible for any independently handled process which may affect the strength properties of the finished panel.

SterlingOSB Zero installation advice

Fixings

- SterlingOSB Zero should be face fixed using approx. 3mm diameter ring-shank nails or screws, 50mm long at 100mm centres across the supporting joists
- Panels must be laid with long edges at 90° to supports and short edge joints must be staggered
- All short edges must be supported on joists / studs or noggins
- Panel edges must bear approx. 18mm onto joists
- Nailing must be at least 8mm from the panel edges

- All T&G joints should be glued with a PVA adhesive
- Panels should be fixed using approx. 3mm ring-shank nails or screws whose length is 2.5 times the thickness of the panel in flooring or 50mm in roofing
- Whilst not essential, gluing of the panels to joists increases the stiffness and strength of the structure. Additionally gluing can help reduce any potential squeaks or creaks. We recommend using CaberFix Joint&Joist

Expansion gaps

Square edged
With all square edged panels, a 3mm expansion gap should be allowed between boards and edges.

Tongue and Groove (T&G)
Tongue and Groove has an expansion gap included in the T&G joint. A 10mm expansion gap, or a total of 2mm per metre of boarding, (whichever is the greater), must be left at perimeters and upstands for both square edged and T&G panels.

Spans & nailing centres	Flooring		Flat Roofing			Sarking	Sarking under slates	Sheathing
	15	18	11	15	18	9	18	9
Thickness (mm)	15	18	11	15	18	9	18	9
Max. span* (domestic) (mm)	450	600	400	600	610	600	610	610
Nail centres (edges) (mm)	300	300	100	100	100	150	100	150
Nail centres (intermediate) (mm)	300	300	100	100	100	300	100	300
Weight kg/m ² (approx.)	9.6	11.7	7.3	9.6	11	3.5	11	3.5
Face smooth nail retention** (N)	265	320	184	265	320	158	320	158
Edge screw retention (N)	673	647	592	673	647	–	647	–
Face screw retention (N)	833	854	692	833	854	625	854	625

* Refer to tables on page 72 regarding UDL Limits.

** Compared to smooth nails, improved nails will improve retention performance by around 50%

SterlingOSB Zero StrongFix

Step-by-step installation instructions

SterlingOSB Zero StrongFix is designed to be installed in standard metal C-stud with 600mm centres.

Step 1. Fit L-shaped steel to panels

Cut L-shaped steel to the same length as the SterlingOSB Zero StrongFix panels to be fitted, and fix to the back of the non-recessed side with a 1mm overlap (to allow for expansion). Using a minimum 25mm self-tapping drywall screw, fix 10mm from top and bottom and at 250mm centres maximum.



Step 2. Position panels in metal C-stud

By angling the SterlingOSB Zero StrongFix panel, match the panel's recess with the lip of the metal C-stud then swing the panel to align flush with the next metal C-stud. Slide the panel up or down the metal C-studs to the area of wall that is required to be strengthened.



Step 3. Fix panels in place

Secure the panel in place, first by fixing the L-shaped steel to the metal C-stud with 13mm self tapping metal drywall screws at 250mm centres so that SterlingOSB Zero StrongFix is flush with the metal C-stud. Secondly, secure the recessed side by fixing directly through the metal C-stud into the panel using a minimum 25mm self-tapping drywall screw, fix 10mm from top and bottom and at 250mm centres maximum.

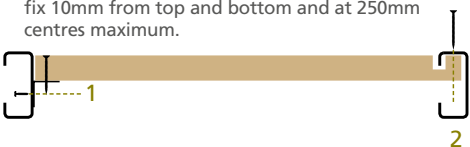

SterlingOSB Zero StrongFix anchorage values

Independently tested anchorage data when installed in accordance with Norbord recommendations and according to BS 5234-2:1992 - Partitions - Part 2: Specification for performance requirements for strength and robustness including methods of test:

Fixing size (wood screws)	BS 5234-2 Requirement		Max. Recommended Safe Working Load
Pull Out SWL			
3.5 x 40mm	100N	Pass	100kg
4.0 x 50mm	100N	Pass	100kg
5.0 x 50mm	100N	Pass	110kg
Pull Down SWL			
3.5 x 40mm	250N	Pass	50kg
4.0 x 50mm	250N	Pass	60kg
5.0 x 50mm	250N	Pass	70kg
Heavyweight anchorage (wash basin) SWL			
5.0 x 50mm	1,000N	Pass	100kg
6.0 x 60mm**	1,500N	Pass	150kg
Heavyweight anchorage (wall cupboard) SWL			
4.0 x 50mm	2,000N	Pass	200kg
5.0 x 50mm	4,000N	Pass	400kg

** Full sized dry lining panels required for 1,500N SWL = Safe Working Load

SterlingOSB Zero SiteCoat certification



SterlingOSB Zero SiteCoat is an environmentally friendly OSB product that has achieved the following certifications.

All Norbord timber is sourced from sustainably managed forests.

- FSC (Forest Stewardship Council®)
- ISO 14001:2015 Environmental Management**
- BS EN 300:2006 Oriented Strand Boards (OSB) - definitions, classification and specifications
- BS EN 13986:2004+A1:2015
- CE 2+ attestation of conformity
- BS EN ISO 9001:2015 Quality Management Systems
- BBA (British Board of Agreement 01/3857)
- Sintef (Norway)

SterlingOSB Zero Fire Solutions at a glance

SterlingOSB Zero Fire Solutions has been developed specifically in response to the STA (Structural Timber Association) published guidelines for reducing fire spread in large (total floor area >600m²) timber frame buildings during the construction phase when fire resistant finishes (dry lining) are not yet in place.

STA guidelines

The purpose of the guidelines is to reduce potential radiant heat emissions to acceptable levels, so that the risk of fire spread to neighbouring buildings is controlled should a fire occur during the construction process.

Completed timber frame buildings (dry linings fixed) are then fully compliant with the Building Regulation fire protection requirements.

The guidelines enable the designer either to specify a type of timber frame with inherently reduced fire spread properties or, where suitable, to adapt the construction process to allow the use of standard open panel timber frame.

The guide includes three generic categories of timber frame with increasing resistance to fire spread and associated reduction in radiant heat to neighbouring buildings, as well as giving a detailed test and approval protocol by which systems or product assemblies can demonstrate compliance with any given category.

These categories allow the designer to select the appropriate frame specification to construct a timber frame building based on the separating distances present on the site.

The three generic categories of timber frame are:

Category A
Standard open panel timber frame

Category B
Reduced fire spread timber frame

Category C
Fire spread resistant timber frame

SterlingOSB Zero Fire Solutions is designed, when used in conjunction with Rockwool insulation, to match the categories in STA guidelines:

SterlingOSB Zero FS-300
SterlingOSB Zero OSB3 18mm with intumescent coating on both sides of the panel.

Suitable for FR Build decking.

Matrix of wall and floor assemblies providing STA category solutions to fire spread during construction phase

		STA floor reference (Deck and Joist details)			
		F3.2	Alternative F3.2	Alternative F3.1	F4
STA wall reference (Sub-classification)		FR Build decking	Rockwool protected 15mm untreated OSB/3	Rockwool protected 15mm untreated OSB/3	15mm untreated OSB/3
		Rockwool protected OSB-web I-joists	Rockwool protected OSB-web I-joists	FR Build solid timber joists	Untreated solid timber or OSB-web I-joists
W7	9mm OSB/3 sheathing - NoBurn intumescent both sides	B3	B3	B3	B3
W8	9mm OSB/3 sheathing - NoBurn intumescent both sides with A1/A2 internal lining	C	C	C	C

† refer to section 6, combination 4, STA Product Paper 4

F3.2 This system achieves 2 points*

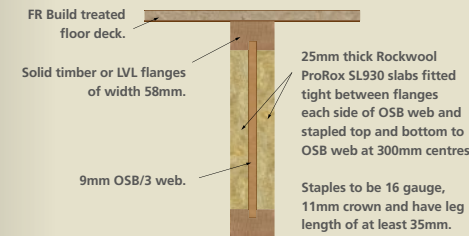

Alternative F3.1 This system achieves 2 points*

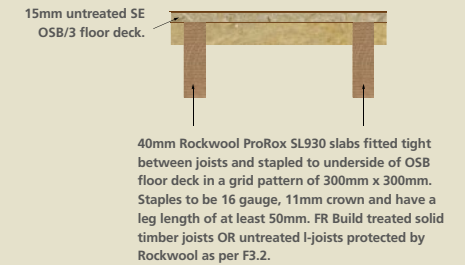

Alternative F3.2 This system achieves 2 points*

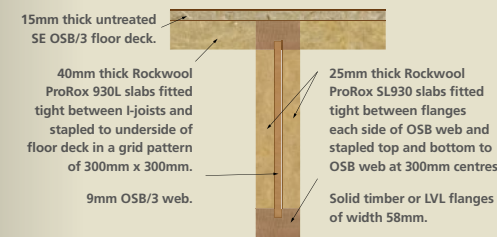

F4

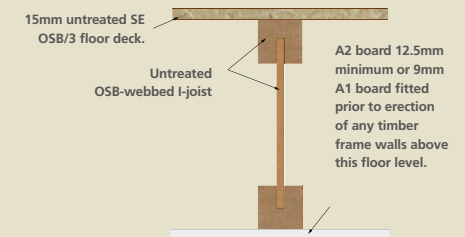

W7 This system achieves 4 points*

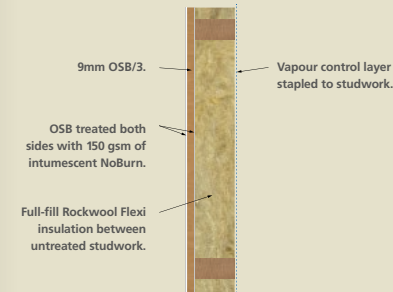

W8 This system achieves 5 points*

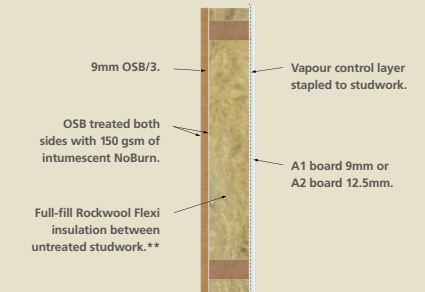

*In accordance with STA Product Paper 4. **Also possible to use Full Fill FI Type 2 Insulation between untreated studwork (Glass wool).

CaberBoard technical data

CaberFloor P5, CaberDek, CaberShieldPlus and CaberAcoustic

	Unit	18mm	22mm
Panel Weight	kg/m ²	12	15
Panel Weight (2400×600mm)	kg	17.3	21.6
Density	kg/m ³	660 ± 30	660 ± 30
Internal Bond strength (IB) (After cyclic test)	MPa	0.45	0.40
	MPa	0.22	0.2
Modulus of Rapture (MoR)	MPa	16	14
Modulus of Elasticity (MoE)	MPa	2400	2150
Moisture Content	%	5-8	5-8
Thickness Swelling 24hr immersion After cyclic test	%	10	10
	%	12	11
Standard Deviation of Thickness Within boards Between boards	mm	± 0.2	± 0.2
	mm	± 0.5	± 0.5
Dimensional Stability Length / Width Thickness	%	0.25	0.25
	%	7.0	7.0
	%	7.0	7.0
Low Emission Grade E1 (Formaldehyde EN 120)	mg/100g	≤8.0	≤8.0
Reaction to Fire (EN 13501-1)		Class D _{FL} -S1	Class D _{FL} -S1

These values are typical 95%ile values when the products are tested in accordance with European Standards test methods for Particle Boards BS EN 312.

CaberDek removable film

	Unit	Test method	Value
Film weight	g/m ²	DIN 53365	70
Tensile strength MD	N/15mm	DIN EN ISO 527	55
Tensile strength CD	N/15mm	DIN EN ISO 527	45
Ultimate elongation MD	%	DIN EN ISO 527	700
Ultimate elongation CD	%	DIN EN ISO 527	500
Tear propagation strength MD	N	DIN 53363	35
Tear propagation strength CD	N	DIN 53363	30
Water Vapour Permeability (23°C/85%r.F.)	g/m ² /d	DIN 53122	0.36
Temperature extremes	°C	In-house	- 40 / + 80
Puncture resistance	N	MIL STD 3010-2065	55

* In accordance with STA Product Paper 4.

** Also possible to use Full Fill FI Type 2 Insulation between untreated studwork (Glass wool).

Product sizes available

Product	Application	Thickness (mm)	Size (mm)	Edge profile
CaberFloor P5	Structural flooring	18, 22	2400 × 600	TG4
CaberDek	Structural flooring	18, 22	2400 × 600	TG4
			2400 × 1200	TG2
CaberShieldPlus	Structural flooring	18, 22	2400 × 600	TG4
CaberAcoustic	Overlay flooring	28, 32	2400 × 600	TG4
CaberBoard P1	Non-structural general use	12, 18	2440 × 1220	SE
CaberBoard P2/P3	Furniture & Kitchen worktops	various*	various*	SE

* Contact our customer service team for more information

CaberBoard storage and conditioning

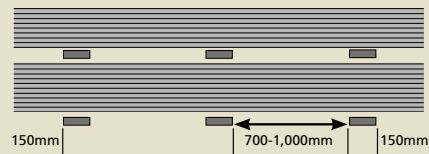

Correct method of storage on bearers

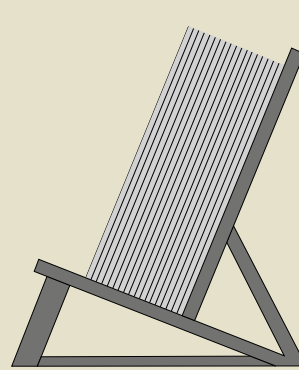

Correct method of edge stacking

Storage

On delivery, boards should be stacked on equidistantly spaced bearers in a dry, covered area with outside storage adopted only as a last resort. If storage outside is unavoidable, stack on dry level ground and protect the boards by covering with a polythene or waterproof sheet. Ensure that the board edges are covered and secured to avoid lifting by the wind.

An HSE information sheet on the 'safe stacking of sawn material and board materials' is available in our document library at www.norbord.co.uk

Handling

Like all panel products, Norbord MDF, Particleboard and OSB should be handled carefully to prevent the risk of boards slipping or toppling and potential injury.

As a duty of care to our customers, Norbord has undertaken extensive testing of our packaging and strapping to ensure our products arrive safely.

End users are responsible to ensure that appropriate risk assessments are undertaken and safe procedures are in place.

Conditioning

Wood particleboards expand on taking moisture from surrounding air (plus effects of wet trades, site conditions etc.) and shrink on losing it. As a guide, a small increase in moisture of 1% increases length and width by 0.25mm per metre. A decrease in moisture of 1% will have a corresponding shrinkage effect. It is clearly desirable to minimise these changes, which can be applied pro-rata, by taking a few simple precautions. Boards should be allowed to reach equilibrium by storing them under the atmospheric conditions in which they are to be used, for a minimum of 48 hours prior to laying. It is recommended that boards are loose stacked, on a minimum of 3 equi-spaced bearers, with spacers between each board to allow free air movement.

Relative humidity	Approximate equilibrium at 20°C moisture content
30%	7%
65%	11%
85%	15%

Equilibrium moisture content

Moisture content

All wood is hygroscopic. Its moisture content, therefore depends on its environment. The moisture content which wood and wood-based products will attain in service (equilibrium moisture content) depends primarily on the atmospheric humidity.

Floors should be laid at a moisture content within the range likely to be encountered in service. They should also be laid after the initial drying out period is complete. It should be noted that sometimes extreme site conditions can lead to shrinkage when the building is finally occupied / heating commissioned etc. CaberBoard products are made at relatively high ex-works moisture contents compared to industry norms.

Whilst no product containing around 80% wood in its composition can be unaffected by moisture – CaberFloor P5 at ex-works (around 5-8 % moisture content) is close to the natural equilibrium moisture content of particleboards (see table) and is consequently an excellent choice.

Note:

Care should be taken to ensure any joists treated with a waterborne preservative have thoroughly dried out before installation. Joist moisture content should not exceed 20%. High moisture content in the timber could lead to distortion as they dry out leading to 'creaks', particularly if the boards are not glued. Some contractors prefer to additionally bond the underside of the board to the top of the joist (using PVA adhesive).

Any access traps for underfloor services should be pre-planned and support provided for all sides of the traps.

CaberBoard installation advice

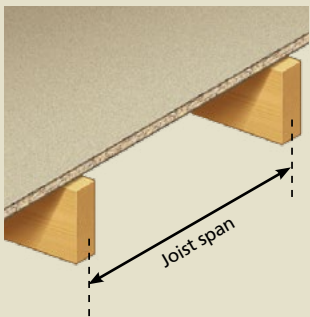

Panel thickness is dependent on joist span



T&G panels are laid with long edges across the joists

Panel thickness

On joists up to 450mm centres use 18mm board.

On joists up to 600mm centres use 22mm board

Tongued & Grooved panels

Tongued & Grooved panels should be laid in a staggered pattern with long edges across the joists and short edges falling on the centre of joists. Support between joists is not necessary. Should the short edges overhang then the overhang must be supported by a noggin.

Gluing T&G joints is recommended. It improves joint strength and accommodates a degree of joist variation. All joints must be glued with CaberFix adhesive (J&J, D3 or D4, dependent on panel type), otherwise, joist movement or variation may lead to movement and 'creaks'. Boards can be fixed by nailing or screwing. If nailing, annular ring shank nails should be used for fastening all edges to the joists.

If screw fixing, use a suitable pilot hole followed by Posidriv No. 8 particleboard screws, or equivalent. Fix the boards with four fixings to each short edge joint, two about 25mm from each end and two equidistant in between. All joints must be tightly butted. Length of fixings used should be 2.5 times the thickness of the board. Four equidistant fixings should be used on panel ends and three at intermediate joints.



SE panels are laid with long edges in-line with the joists

Square Edged (SE) panels

SE panels should be laid with the long edges falling on the joist centres and with the short edges supported by 38mm wide noggins with their ends secured to joists.

Nail the boards to all supports 200-300mm apart with annular ring shank nails round the edges of the board and at 300mm centres on intermediate joists. The nails used should be 2.5 times the thickness of the board. All joints must be tightly butted.



10mm minimum expansion gap should be applied to the perimeter

Perimeter expansion gap

CaberFloor P5, when laid in a new building, will tend to absorb moisture and expand in common with other wood-based materials. It is important to leave an expansion gap of 2mm per metre run of board between the edge of the floor and the perimeter wall or any solid abutment (minimum gap 10mm). For larger areas it is necessary to incorporate intermediate expansion gaps to provide the necessary allowance for possible movements, particularly in corridor applications. Attention must be paid to maintaining expansion gaps at all times during construction.

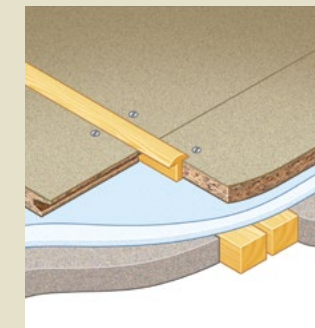

In large areas or long runs additional expansion gaps should be included

Additional movement gaps

It is well documented and strongly recommended that additional movement gaps are incorporated in large areas or long runs e.g. corridors. BS 8201:2011 Code of practice for installation of flooring of wood and wood-based panels recommends an expansion provision of 2mm per metre run plus 1mm for every metre above 12m of the width and breadth of the floor. A simple movement provision can be made according to the diagram above and also proprietary systems are available to suit a wide range of applications.

CaberBoard installation advice

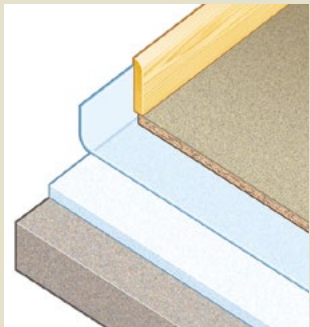

Continuously supported floating floor

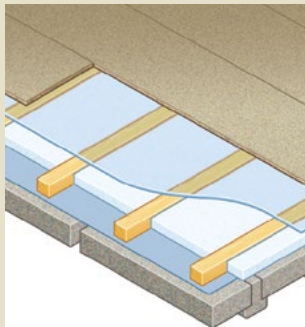

Battened floating floor

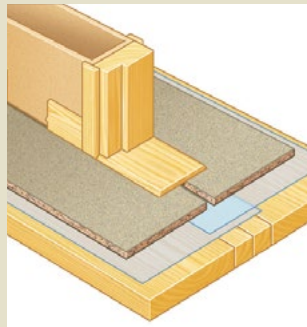

Doorway threshold

Continuously supported floating floor

It is essential that a continuous damp proof membrane – not less than 1000 gauge polythene – is used. This must be laid in accordance with CP102:1973. A continuous layer of insulation is used above the structure of pre-cast concrete beam and block.

The insulation may be incorporated in the screed. Most commonly, when used in conjunction with CaberFloor P5 as the floating floor overlay, the insulation is immediately below the flooring and laid onto the slab or beam and block, with vapour control layer between flooring and insulation. Any unevenness, localised or general, may transmit through the CaberFloor P5 layer, therefore subfloor flatness is important. The insulation material should be rigid and suitable for the loading requirements.

Battened floating floors

Use additional support battens where extra floor loading is anticipated and the exact position is known, e.g. beneath kitchen equipment and sanitary fittings. When required, use a levelling screed to ensure that the battens of a timber battened system are true and level. Do not attempt to fix the flooring to the battens through resilient insulation material, as this will create an uneven floor.

If necessary lightly sand and clean floors to make the surface suitable for further overlays, e.g. thin plywood, vinyl etc. Do not wash or scrub with water.

Advice on door thresholds

At all door openings, support the edges of the panels on preservative treated timber battens. Ensure that battens are on a firm and level base and fix a strip of flooring to the battens as a threshold. Allow a gap on each side of the threshold for movement in the flooring panels.

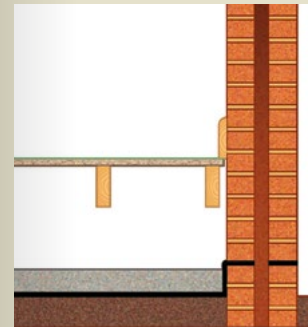

Joisted floor

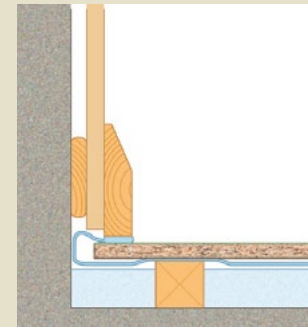

Vapour control layer with battened floor

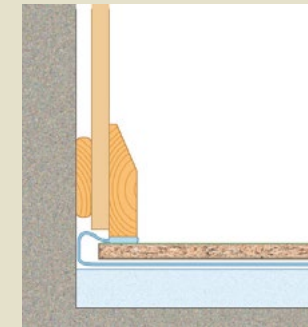

Vapour control layer without battened floor

Joisted / suspended timber floors

Joisted or suspended timber floors have an advantage in that they can accommodate the required thickness of insulation within the structure. The insulation materials may be mineral wool supported on boards (or netting) or rigid foam insulation simply supported on timber battens.

The board may be mechanically fixed to the joists and the underside of the board glued to the top of the joist for additional strength. Independent tests have shown a 10% strength increase by gluing as above. Maintain adequate cross ventilation of the subfloor space, taking care not to obstruct ventilators by insulation material or timber struts in the subfloor. Use herringbone struts in preference to solid strutting e.g. above sleeper walls.

Advice on moisture protection

CaberFloor P5 is a highly durable product. Similar to other wood-based panels it is affected by moisture. Good practice on installation and protection against moisture in construction is advised. We recommend, with or without battens in the floating floor construction, that 1000 gauge polythene should be used as a continuous Vapour Control Layer (VCL) between the CaberFloor P5 and the insulation material.

CaberBoard installation advice

T&G panel fixing methods*

Dependent on whether gluing or mechanical fixing to joists, the following advice should be noted:

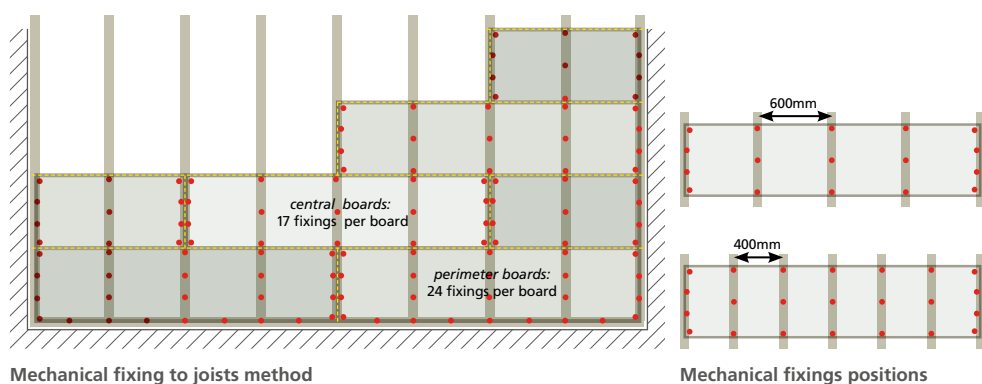
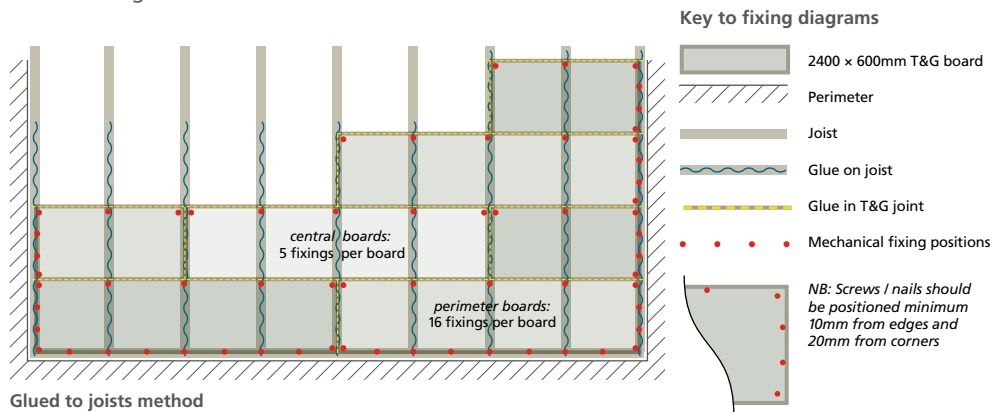

Mechanical fixing to joists method

*Mechanical fixing methods do not apply to CaberAcoustic when used as a floating floor overlay

Taping CaberDek

When using CaberFix Joint&Joist, for BBA approval use CaberFix Tape on all joints, perimeters and mechanical fixings.

In extreme cold conditions, CaberFix X-Treme Tape should be used instead, as it withstands cracking or lift in temperatures down to -21°C.



Soft and resilient floor coverings

The Codes of Practice – BS 8203, WPIF floating flooring installation code of practice and BS 5325 recommends that for all overlays the subfloor must be clean, rigid and flat. When thin or shiny floor surface materials are laid over CaberBoard these materials may allow board joints to show through, particularly after trafficking. Prior to laying such materials, the CaberBoard joints should be checked for level. It is permissible to sand off any raised areas not exceeding 1mm. For raised areas greater than 1mm, additional levelling materials are required.

Thin, plain coloured carpets or vinyls or those with a high sheen – tend to show small irregularities to a greater degree. For thin vinyls and tiling, it is recommended that a plywood overlay (4mm) is fixed in position, staggering joints so as not to coincide with CaberBoard joints. The plywood should be fixed every 100mm using appropriate nails or screws around perimeter and 150mm apart elsewhere, ensuring they do not protrude above the surface. Adhesive manufacturer advice should be followed for priming of new surfaces. Usually, this involves a coat of diluted PVA emulsion.

Ceramic tiling

Guidance as to construction of bases in respect to considerations and timber bases is given in BS 5385-3:2007. Tiling onto CaberBoard flooring should be undertaken only in joisted / fixed floor constructions. Noggins should be used between the joists at 300mm centres and the surface provided for tiling should be 15mm exterior grade plywood screwed to joists and noggins at 300mm centres. Existing boards can therefore be overlaid with 15mm exterior grade plywood to provide the necessary rigidity for a tiled surface. Length of fixings should be 2.5 times overall board thickness. A tile adhesive is the recommended bond material – cement / sand mortars are not recommended.

Underfloor heating

CaberBoard flooring is suitable for use when installing hydronic underfloor heating systems.

Acoustic performance

CaberBoard flooring can be used effectively on acoustic battened floor systems.

These systems are often used in flatted developments to achieve 'Part E' requirements of UK Building Regulations.

For more info on acoustic flooring see page 92.

CaberAcoustic systems

Acoustic performance

CaberAcoustic is a highly versatile and economical sound reducing flooring solution. Reducing both impact and airborne transmitted sounds, it can be laid over concrete and timber floors in both new and existing buildings.

- ☑ Available as 28mm or 32mm CaberAcoustic
- ☑ Reduces impact sounds transmission by $\Delta L_w 19\text{dB}^*$
- ☑ Contributes to airborne noise reduction**
- ☑ To be overlaid onto an existing deck
- ☑ Use in conjunction with flanking strip
- ☑ Made in the UK using eco recycled felt

* 19dB sound reduction applies when CaberAcoustic is installed on its own. Greater reductions applicable (see table) when used within a system for noise transference reduction.

**When used in the right system.

Hush System 2003 overlay (HD1014)

Impact $L'_{nT,w}$ dB	51
Airborne $D_{nT,w}$ dB	58
Airborne $D_{nT,w} + C_{tr}$ dB	49

Results based on the CaberAcoustic flooring being used in conjunction with all Hush joist infill and Hush ceiling components (HD1014) and installed as per both manufacturers' installation guides with all flanking paths treated. We recommend that the structure consists of a minimum 200mm joists

Hush System MF28 overlay (HD1038)

Impact $L'_{nT,w}$ dB	51
Airborne $D_{nT,w}$ dB	58
Airborne $D_{nT,w} + C_{tr}$ dB	52

Results based on the CaberAcoustic flooring being used in conjunction with all Hush MF Ceiling components (HD1038) and installed as per both manufacturers' installation guides and all flanking paths treated.

Hush overlay for masonry system (HD1018)

Impact $L'_{nT,w}$ dB	45
Airborne $D_{nT,w}$ dB	62
Airborne $D_{nT,w} + C_{tr}$ dB	55

Results based on the CaberAcoustic flooring being used in conjunction with all Hush MF Ceiling components (HD1018) and installed as per both manufacturers' installation guides and all flanking paths treated.

CaberAcoustic

For use in conversion and refurbishment development in conjunction with Hush Acoustics joist infill and ceiling system (HD1014).

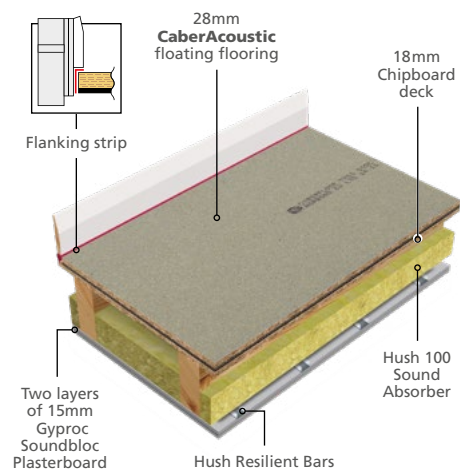

Product data

- CaberAcoustic 28, all T&G joints to be glued using CaberFix D3 adhesive. CaberAcoustic panel to be laid over 18/22mm T&G chipboard or existing floorboards. All perimeters of the CaberAcoustic panel to be sealed using the flanking strips.
- Hush 100 Sound Absorber fitted between joists with Hush Resilient Bars screw fixed to the underside of joists at 600mm centres.
- Two layers of 15mm Soundbloc Plasterboard to be installed to the underside of the Resilient Bar. Seal all perimeters with an Acoustic Sealant prior to skimming.

Features

- ☑ Complies to UK Building Regulations Approved Document E (England & Wales), Section 5 (Scotland) and Part G (Northern Ireland)
- ☑ A fully developed economical sound insulation system to be used to form a separating floor construction in refurbishment and conversion development with timber joists
- ☑ Provides a 1 hour fire resistance at ceiling level

CaberAcoustic

Can be used in timber joisted floor applications in new build, conversion and refurbishment developments in conjunction with the Hush MF Ceiling System and Hush 100 Sound Absorber (HD1038).

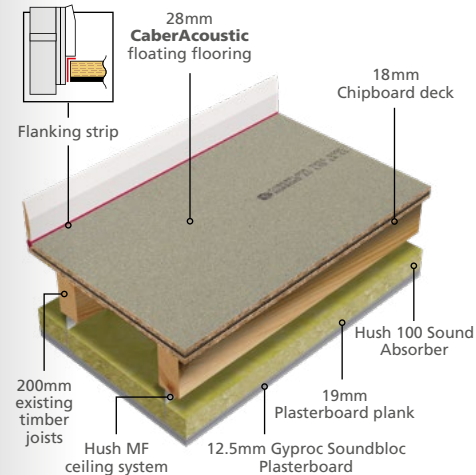

Product data

- CaberAcoustic 28, all T&G joints glued using CaberFix D3 adhesive, laid over 18mm/22mm chipboard deck, with all perimeters sealed using a flanking strip.
- Install the Hush-MF system to the underside of the joists creating a minimum 150mm void from the underside of the joists to the back of the plasterboard lining. Install the Hush 100 Sound Absorber tightly together within the ceiling void.
- Install a double plasterboard layer to the underside of the Hush-MF system. The plasterboard lining should consist of 19mm plasterboard plank and 12.5mm Soundbloc. Seal all perimeters.

Features

- ☑ Complies to UK Building Regulations Approved Document E (England & Wales), Section 5 (Scotland) and Part G (Northern Ireland)
- ☑ A fully developed, economical sound insulation system for use in separating floor / ceiling construction in conversion, refurbishment and new build developments
- ☑ Provides a 1 hour fire resistance at ceiling level

CaberAcoustic

Can be used with concrete floor structures of 300-365 kg/m² in new build, conversion and refurbishment developments in conjunction with the Hush MF Ceiling System and Hush 100 Sound Absorber (HD1018).

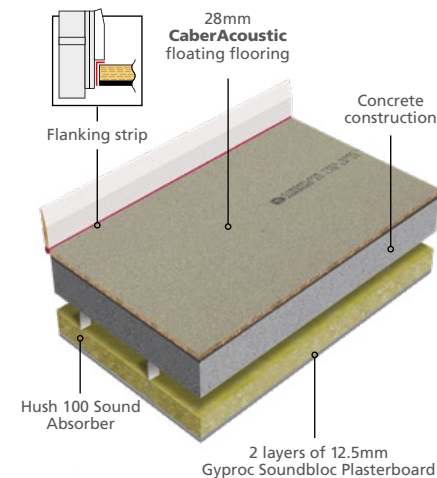

Product data

- CaberAcoustic 28, all T&G joints glued using CaberFix D3 adhesive, with all perimeters sealed using a flanking strip, laid over 200mm in situ concrete slab.
- Install the Hush MF Ceiling to the underside of the masonry construction. Ensure a 150mm void is created from the underside of the beam and block to the back of the plasterboard lining.
- Install the Hush 100 Sound Absorber within the Hush MF Ceiling System.
- Install a double layer of 12.5mm Soundbloc Plasterboard to the underside of the Hush MF Ceiling System.

Features

- ☑ Complies with UK Building Regulations Approved Document E (England & Wales), Part G (Northern Ireland) and Section 5 (Scotland)
- ☑ A fully developed economical sound insulation system between separating floors

CaberWood MDF technical data

Values are typical values in accordance with EN standards, BS EN 622-5:2009 for Fibreboards: Specification – Part 5: Requirements for dry process boards (MDF).

Note:

Using BS EN 120.
Thickness tolerance for all grades is:
± 0.2mm ≤ 22mm
± 0.3mm > 22mm
PCP values are less than 5 ppm.

Low emission

All CaberWood MDF products conform to the latest European low emission standards

CaberWood MDF Trade

Property	Unit	≥4–6 mm	>6–9 mm	>9–12 mm	>12–19 mm	>19–30 mm	>30–45 mm
Thermal Conductivity 'K' Value	W/m.K			0.1	0.1	0.1	
Internal Bond (IB)	N/mm ²			0.45	0.45	0.45	
Modulus of Rapture (MoR)	N/mm ²			20	18	15	
Modulus of Elasticity (MoE)	N/mm ²			1700	1600	1500	
Thickness Swelling (24hr immersion)	%			16	14	12	
Moisture Content [ex-plant]	%			5-7	5-7	5-7	
Reaction to Fire*	BS EN 13501:1:2007+A1:2009			D	D	D	
Formaldehyde Class	EN 13986:2004+A1:2015			E1	E1	E1	

CaberWood MDF Trade MR

Property	Unit	≥4–6 mm	>6–9 mm	>9–12 mm	>12–19 mm	>19–30 mm	>30–45 mm
Thermal Conductivity 'K' Value	W/m.K			0.1	0.1	0.1	
Internal Bond (IB)	N/mm ²			0.45	0.45	0.45	
Modulus of Rapture (MoR)	N/mm ²			20	18	16	
Modulus of Elasticity (MoE)	N/mm ²			1700	1600	1500	
Thickness Swelling (24hr immersion)	%			16	13	12	
Moisture Content [ex-plant]	%			5-7	5-7	5-7	
Reaction to Fire*	BS EN 13501:1:2007+A1:2009			D	D	D	
Formaldehyde Class	EN 13986:2004+A1:2015			E1	E1	E1	

CaberWood MDF Pro

Property	Unit	≥4–6 mm	>6–9 mm	>9–12 mm	>12–19 mm	>19–30 mm	>30–45 mm
Thermal Conductivity 'K' Value	W/m.K	0.14	0.13	0.13	0.13	0.13	0.13
Internal Bond (IB)	N/mm ²	0.65	0.65	0.6	0.55	0.55	0.5
Modulus of Rapture (MoR)	N/mm ²	23	23	22	20	18	17
Modulus of Elasticity (MoE)	N/mm ²	2700	2700	2500	2200	2100	1800
Thickness Swelling (24hr immersion)	%	30	17	15	12	10	8
Moisture Content [ex-plant]	%	5-7	5-7	5-7	5-7	5-7	5-7
Reaction to Fire*	BS EN 13501:1:2007+A1:2009	D	D	D	D	D	D
Formaldehyde Class	EN13986:2004+A1:2015	E1	E1	E1	E1	E1	E1

CaberWood MDF Pro MR

Property	Unit	≥4–6 mm	>6–9 mm	>9–12 mm	>12–19 mm	>19–30 mm	>30–45 mm
Thermal Conductivity 'K' Value	W/m.K	0.14	0.13	0.13	0.13	0.13	0.13
Internal Bond (IB)	N/mm ²	0.7	0.8	0.8	0.75	0.75	0.7
Modulus of Rapture (MoR)	N/mm ²	27	27	26	24	22	17
Modulus of Elasticity (MoE)	N/mm ²	2700	2700	2500	2400	2300	2200
Thickness Swelling (24hr immersion)	%	18	12	10	8	7	7
Moisture Content [ex-plant]	%		5-7	5-7	5-7	5-7	5-7
Reaction to Fire*	BS EN 13501:1:2007+A1:2009		D	D	D	D	D
Formaldehyde Class	EN 13986:2004+A1:2015		E1	E1	E1	E1	E1

CaberWood MDF Industrial

Property	Unit	≥4–6 mm	>6–9 mm	>9–12 mm	>12–19 mm	>19–30 mm	>30–45 mm
Thermal Conductivity 'K' Value	W/m.K			0.13	0.13	0.13	
Internal Bond (IB)	N/mm ²			0.9	0.9	0.9	
Modulus of Rapture (MoR)	N/mm ²			26	24	22	
Modulus of Elasticity (MoE)	N/mm ²			2500	2400	2300	
Thickness Swelling (24hr immersion)	%			10	8	7	
Moisture Content [ex-plant]	%			5-7	5-7	5-7	
Reaction to Fire*	BS EN 13501:1:2007+A1:2009			D	D	D	
Formaldehyde Class	EN 13986:2004+A1:2015			E1	E1	E1	

*Refer to EN13986:2004+A1:2015, Table 8, for End Use Classifications

CaberWood MDF storage and conditioning



CaberWood MDF panel weight guide

For lifting & handling purposes using an 18mm panel thickness, the following should be used as a guide weight (kg per m²).

- CaberWood Trade MDF / Moisture Resistant 10 kg/m²
- CaberWood Pro MDF / Moisture Resistant 13 kg/m²
- CaberWood Industrial MDF 14.5 kg/m²

Note: Calculations for guide weights for thicknesses other than 18mm, are pro-rata, e.g. 12mm CaberWood MDF Trade = 10 kg/m² x 12/18 = 6.7 kg/m².

Transport and storage

CaberWood MDF should be:

- Transported in uniform stacks on a flat base to avoid damage
- Protected against the weather
- Stored on a rigid flat base and adequately ventilated
- Insulated from the ground to avoid dampness

When wooden bearers are used, they should be of uniform thickness and placed in line. The distance between bearers should be no greater than 700–1,000mm.

An HSE information sheet on the 'safe stacking of sawn material and board materials' is available on request.

Conditioning

Wood panel products expand on taking moisture from surrounding air and shrink on losing it. As a guide, a small increase in moisture of 1% increases length and width by 0.25mm per metre. A decrease in moisture of 1% will have a corresponding shrinkage effect.

It is clearly desirable to minimise these changes, which can be applied pro-rata, by taking a few simple precautions. Boards should be allowed to reach equilibrium by storing them under the atmospheric conditions in which they are to be used, for a minimum of 48 hours prior to laying. It is recommended that boards are loose stacked, on a minimum of 3 equi-spaced bearers, with spacers between each board to allow free air movement.

Moisture content

All wood is hygroscopic. Its moisture content, therefore depends on its environment.

The moisture content which wood and wood-based products will attain in service (equilibrium moisture content) depends primarily on the atmospheric humidity.

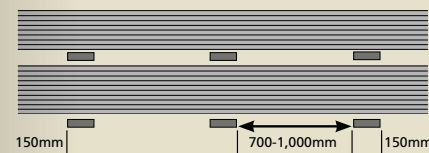

Correct method of storage on bearers

Relative humidity	Approximate equilibrium at 20°C moisture content
30%	7%
65%	11%
85%	15%

CaberWood MDF machining advice

CaberWood MDF has a consistent density and a smooth surface that is ideal for machining, profiling, painting, or the application of paper foils and veneers. In many respects, CaberWood MDF can be treated as a high quality timber, but without the inherent defects of knots and grains.



Profiled edges require no edge banding or lipping

Machining

CaberWood MDF is a homogeneous wood fibre material, ideally suited to modern machine tooling.

CaberWood MDF can be worked easily with all conventional woodworking machines. It saws cleanly and drills easily. It also shapes and routs exceptionally well, without splintering or chipping. CaberWood MDF is equally suited for use with most hand tools.

Profiling

Profiled edges require no edge banding or lipping. Sculptured or textured effects can be machined or embossed, and narrow or small door frames can be produced from a single piece of board.

A major advantage of CaberWood MDF is the relative ease of finishing perpendicular and moulded edges without the need for elaborate filling or the application of adhesive bonded edging materials. This characteristic derives from the uniform density of CaberWood MDF, and the absence of core voids which would require filling.



Sanding after moulding or routing produces a much smoother finish.

Sanding

Sanding after moulding or routing produces a much smoother finish. The moulded edges can be sanded with any number of different profile sanders. Various polyurethane based abrasive wheels are available to fit to spindle moulders or in line with a double end tenoner. These wheels can be shaped to the cutter profile using an abrasive paper glued to the desired edge profile.

80/100 grit should be used for the removal of cutter marks. 120/150 grit is usually used for finish sanding with finer grades available, if required.

Sawing

Follow these tips to ensure best results, minimum breakout and a longer tool life:

- Tungsten carbide saws are recommended for general use
- Saw blades should have higher clearance angles and increased tool angles compared with normal wood-working saws
- Clearance angles should be maintained when the saw is serviced. Reduced angles will increase the amount of resin build up. Increased angles will reduce the life between sharpening
- Chipload – which is the thickness of chip cut by each tooth - should be in the range of 0.15 to 0.25mm. The feed rate required to produce this is calculated as follows

$$\text{Feed rate (mm/min)} = \text{Chipload} \times \text{r.p.m.} \times \text{no. of teeth}$$

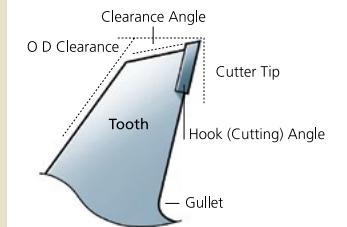
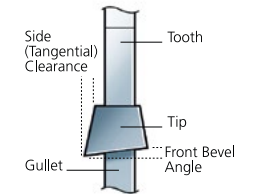
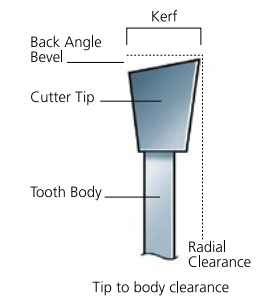

Saw blades and tools should have increased clearance angles to reduce resin build up and reduce the life between sharpening.

CaberWood MDF fixing advice

Mechanical joints and fixings

Mechanical fittings developed for use with particleboard can be applied to MDF with the following recommendations:

- Wherever possible select fittings that depend upon face fixing
- Avoid fittings which depend upon the expansion of a component inserted into the board edge
- When using screws follow the pilot hole dimensions recommended below

Screwing

The internal bond strength of CaberWood MDF gives substantially better screw holding over other types of panel products.

Type of screw

Most types of screw can be used. Best results are obtained with parallel thread screws. A high overall diameter to core ratio is desirable.

Positioning

Screws which are inserted into the face should not be less than 25mm from the corners. Screws inserted into the edge should not be less than 70mm from the corners. Do not over tighten screws as further turning after screws are tight will reduce the holding power.

Pilot holes

Larger diameter pilot holes than those recommended for solid wood and particleboard are required in faces and edges of MDF to accommodate the core of the screw. For GKN Superscrews the recommended pilot diameter should be 85% to 95% of the screw core diameter.

This requirement is particularly important when screwing into the edges of thinner boards. Pilot holes should be drilled approximately 1mm beyond the expected depth of insertion of the screws into the board.



Use screws with the non threaded core of a similar length to the thickness of the panel being jointed.

Use screws with parallel thread rather than traditional thread.

Parallel thread Traditional thread

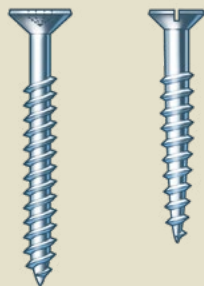

Dowel joints

Dowel holes should be machined with a sharp tool so that the surfaces are free from loose fibre. All dust should be removed prior to assembly. The dowel hole diameter should be slightly larger than the dowel. This will allow good adhesive cover and avoid splitting of the edge.

Dowels with multiple longitudinal or spiral groove patterns ensure uniform adhesive spread within the joint. For best results dowels should be given a total glue coverage. Adhesives such as Polyvinyl Acetate (PVA) or Urea Formaldehyde are preferred as they have good gap filling properties, and their high solid content counteracts absorption of adhesive into the machined edges of CaberWood MDF.

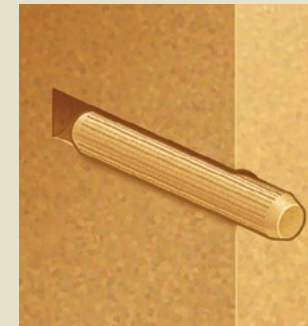

Dowel with 1mm all round clearance preferred.

Smooth dowels are not recommended, grooved dowels are preferred.



Nailing and stapling

Where other methods of fixing are not practical, CaberWood MDF can be fixed with nails. Nails should be spaced 150mm apart to reduce the risk of splitting and at least 70mm from the corners. Nailing the edges of 9mm and 12mm CaberWood MDF is not recommended because of the risk of splitting.

CaberWood MDF can also be fixed using staples. For best results staples should not be inserted closer than 12mm from the edges and 25mm from the corners. This fixing method is only recommended for applications involving light loads. Close spacing of the staples is acceptable but the legs should be aligned at an angle of 15° to the plane of the board.

CaberWood MDF fixing advice *continued*

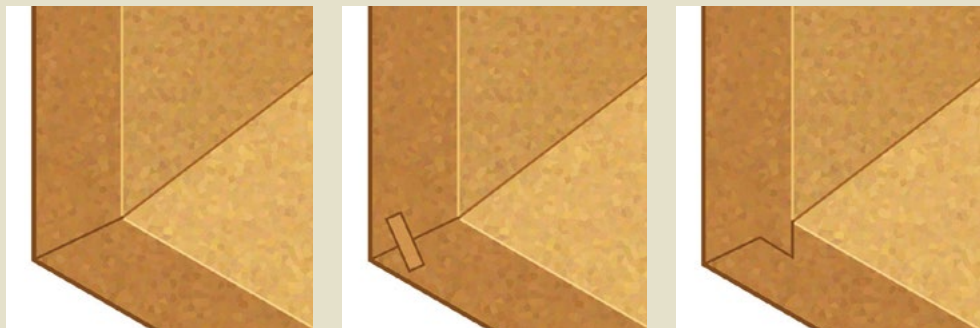

Mitre joints between CaberWood MDF panels

Adhesive bonded joints

A wide variety of jointing methods can be adopted providing the following simple guidelines are observed:

- The joint parts should be accurately machined
- Sharp cutters should be used to avoid tearing or burnishing the surfaces to be bonded
- A high solids content adhesive with gap filling properties should be used. (Polyvinyl Acetate or Urea Formaldehyde)
- Mating pieces should be accurately located and held under pressure while the adhesive is setting
- The width of grooves machined in CaberWood MDF should be limited to about one third of the thickness of the board
- The depth of groove should be about one half of the board thickness
- Adhesive bonded joints should be allowed to condition for several days before sanding and finishing to avoid the appearance of sunken joints. This treatment is essential when using high gloss finishes
- A tongue and groove joint is very efficient, provided the fit of the joints is not too tight as this may cause a split along the edge
- When attaching lippings the tongue should be machined on the solid wood piece

Wall panels

CaberWood MDF can be fixed using conventional dry lining techniques. For best results, follow these recommendations:

- Before fixing, condition the board for a minimum of 24 hours in the area of use
- An expansion gap of 10mm or 2.5mm per metre (whichever is the greater) must be allowed, on length and width
- Gaps are normally left as 'feature gaps', or they may be concealed by a suitable cover strip
- Provision should be made to ventilate the side fixed to battens
- Fix boards to supports with screws as specified at 200mm intervals, 25mm from edges. Screw length should be 2.5 times board thickness. Use 400mm centres for boards of less than 12mm

CaberWood MDF finishing advice

Laminating

Paper foils

The smooth, stable surface of CaberWood MDF makes it an ideal substrate for surfacing with decorative paper.

Flat platen presses developed for wood veneering are normally used for bonding heavier weight foils (80g/m² and higher). Short cycle platen presses and hot roller laminators are normally used for medium and lightweight foils. Adhesive coating weights in the range 80-100g/m² are typical for heavyweight foils and 60-80g/m² for medium and lightweight foils.

PVC foils

PVC foils are normally bonded at room temperature in a roller laminator using copolymer dispersions or epoxy adhesives. The panels emerging from the press should be stacked on a flat base for several hours to allow the bond to achieve full strength before further processing.

Heat transfer foil

Heat transfer foil can be applied to CaberWood MDF by a simple one-step drying process. When wood grain foil has been applied to a surface, a coat of lacquer can be applied by conventional methods to provide additional protection.

Resin impregnated papers

Melamine resin impregnated papers can be laminated to MDF by following the same procedures adopted for melamine-faced particleboard.

Wood veneering

CaberWood MDF's smooth surface provides a suitable substrate for the application of wood veneer using Urea Formaldehyde (UF) or cross linked Polyvinyl Acetate (PVA) adhesives as the bonding agent. The close thickness tolerance on CaberWood MDF ensures uniformity of pressure over all panels in a press load.

Facing and backing veneers must have approximately equal thickness and moisture content to ensure flatness. Wood veneered CaberWood MDF panels should be stacked flat and allowed to cool for a minimum of eight hours before further processing.

Choice of adhesive

CaberWood MDF can be joined with excellent results with most commercial brands of adhesives available to the furniture and joinery Industries. The choice of a specific type of adhesive will be determined by the surface characteristics of the other materials being bonded to the MDF. Consult your individual adhesive suppliers for more detailed specific information.

Adhesive data	Polyvinyl Acetate	Urea Formaldehyde	Neoprene	Copolymer Dispersion	Epoxy	Hot Melt	Polyurethane Solvent Based	PMDI
Wood veneering	●	●			●	●		
Plastic laminate veneering	●	●	●		●			
Paper foil laminating		●		●				
PVC foil laminating				●	●			●
Edge lipping or banding	●	●			●	●		
Assembly jointing	●	●			●	●		
Veneer foil wrapping	●					●	●	

CaberWood MDF finishing advice *continued*

Sealing and painting

The smooth surface of CaberWood MDF makes it suitable for successful finishing with a wide range of coatings.

Alternatively, the natural appearance of the MDF surface can be enhanced using a transparent stain with a clear lacquer topcoat. High gloss or matt finishes can be achieved. The selection of the finishing system, on the basis of chemical type, will depend on the scale of production, application equipment, drying facilities and the expected performance of the finish in relation to the conditions of use. Modern combined systems are possible, e.g. UV sealers, basecoats / AC (acid catalysed) topcoat.

The surfaces to be finished should be free from dust or sanding marks. CaberWood MDF is suitable for most matt finishing treatments without further sanding. An additional light sanding with 180/220 grit is recommended when using high gloss finishes or where a minimum coating thickness is required. High absorption of lacquer or paint into the machined edges of MDF can be prevented by the application of an appropriate sealer such as shellac, polyurethane diluted polyvinyl acetate (PVA) or specially formulated high solids sealers based on two-component catalysed resins. Edge sealing is recommended. The sealed edges can be stained if required, and then finished with one or two coats of clear or tinted lacquer to match the finish on the surface.

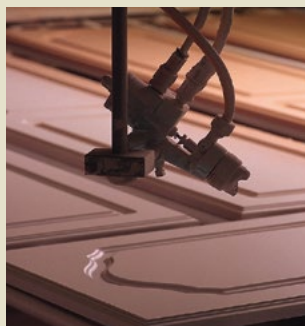

For information and advice on suitability of paints and lacquers contact the following:

FIRA

Furniture Industry Research Association
www.fira.co.uk

SDF

Scottish Decorators Federation
www.scottishdecorators.co.uk

PDA

Painting and Decorating Association
www.paintingdecoratingassociation.co.uk

PRODUCT SAMPLES

We want to ensure you've got the right product for the job, so offer free samples of each of our products. A5 in size, they're individually labelled and wrapped in an informative cover.

To request free samples, visit: norbord.co.uk/samples



COMMITTED TO THE ENVIRONMENT

Norbord is committed to sourcing all of its timber from responsibly managed forests and therefore all of our European sites have the capacity to manufacture to Forest Stewardship Council® standards.



The mark of
responsible forestry

Forest Stewardship Council®

The FSC® product label allows consumers worldwide to recognise products that support the growth of responsible forest management. In an increasingly environmentally aware marketplace many demand the FSC® mark on their wood products – with Norbord it comes as standard.

At Norbord, all of our facilities are regularly visited by a team of environmental auditors, so there is always something better to strive for and a new standard to set. Norbord is a name you can trust to deliver, and to keep its promises.



012

Investing in the environment

Norbord has invested heavily in environmental improvements since 1995. This includes air cleaning technology such as state-of-the-art WESPS (wet electrostatic precipitators). It also means investment in recycling facilities. We can generate as much as half our mills' energy needs by using wood residues as fuel – composting what is left.

By reusing and conserving, we safeguard the environment and keep our costs down. In turn, our products are good for the environment and also good for your budget.

All of our mills have obtained the coveted environmental ISO 14001 accreditation. The ISO 14000 family addresses environmental management. This details what the organisation does to:

- Minimise harmful effects on the environment caused by its activities
- Achieve continual improvement of its environmental performance



VALUES AND BELIEFS

The people of Norbord Europe have adopted a common set of values which have been built through open communication and dialogue reflective of mutual respect.

Commitment to helping our customers be successful

Our people recognise that if our customer relationships are not based on win-win outcomes, then they are not sustainable.

This belief drives our strategy of focusing on key customers and working with them to ensure mutual benefits over the long term. Benefits based on continuing improvements in customer service, product and business development, supply chain effectiveness and technical support.

The only valid gauge of our success in this commitment, is whether our customers believe and say we're doing it.

Trust and personal responsibility in all relationships

We believe that each of our people has the capability and commitment to maximise his / her contribution and the desire to take responsibility for their actions.

Our collective goal is to set clear objectives and to deliver on all promises and commitments. This philosophy applies whether we're engaged with customers, suppliers, fellow members of Norbord, shareholders, or with the community at large.

Excellence as our standard

Our goal is to have an organisation which is capable of excellence and of delivering it consistently in the areas critical to our business. These include the following:

- Safety
- Managing beyond customer expectations
- Supply chain management
- Cost management
- Capacity assurance
- Organisational effectiveness

YOUR CUSTOMER SUPPORT TEAM

Our team are here to help - whatever your need or question, we're at the end of the phone.

Business Development Team

Dedicated to helping our customers increase their sales of our product range.

Whether it be a joint approach to business development, or fulfilling your training needs, our team of Business Development Managers are available to help you. Please see our website for your local contact.

Customer Service Team

Based at our head office near Stirling, Scotland, our team can help you with any questions you might have about availability, deliveries, pricing queries, or anything else you can think of.

Orders should be placed directly via email to: salesorders@norbord.net

Our Internal Sales Team are available via the sales phone line: 01786 819 225

Contact

For general enquiries, technical support or advice on Norbord products please contact us.

General enquiries:

T: 01786 819 225

Technical advice:

SterlingOSB Zero

T: 01463 792 424

**CaberBoard
CaberWood MDF**

T: 01786 819 449

Accounts:

T: 01786 819 214

For more information on any of our products
and technical documentation:

Norbord.co.uk

General enquiries:

T: 01786 819 225

Technical advice:

SterlingOSB Zero

T: 01463 792 424

CaberBoard

CaberWood MDF

T: 01786 819 449



To request free samples,
visit: norbord.co.uk/samples



Norbord Europe Ltd.
Station Road, Cowie FK7 7BQ