



Contents

- 19 THE MARLEY ROOF SYSTEM
- 22 PRODUCT SELECTOR
- 24 MARLEY SOLARTILE®
- 26 BASE LAYERS
- 32 CLAY PLAIN TILES
- 60 CLAY PROFILED TILES
- 68 CONCRETE TILES
- 100 SHINGLES & SHAKES
- 112 DRY FIX AND VENTILATION SYSTEMS
- 116 DESIGN CONSIDERATIONS
- 141 DESIGN DETAILING
- 182 DECKING
- 190 SUSTAINABILITY & SERVICES



IMAGE REPRESENTATION
The images of tiles used throughout the guide offer a good representation of colour and texture, however both can vary due to material and manufacturing processes. Where possible a range of installed and close-up photography is provided to reflect the lighting variation and detailing. Our sample service enables you or your client to see an example of a tile up close. To request yours visit

marley.co.uk/samples

The definitive guide to roofing

As one of the industry's foremost innovators for close to a century, Marley does more than any other manufacturer to shape the roovescape of modern Britain.

We are able to offer the most comprehensive pitched roof system on the market, with more knowledge, more elements guaranteed to work together, more integration of product and service, and more accountability.

Our solutions give you the time to focus on your project, and offer complete peace of mind, as well as better, more durable, lower maintenance roofs.

INSPIRATION GALLERY

Looking for more inspiration? Take a look at our wide range of case studies at marley.co.uk/case-studies



GOLDEN MEDE page 4

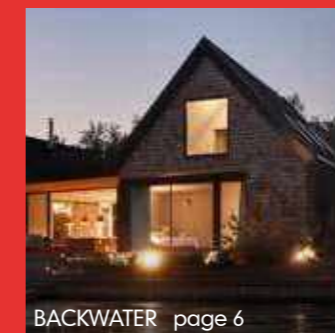

BACKWATER page 6



WIXAMS page 8



PINE LAKE page 10

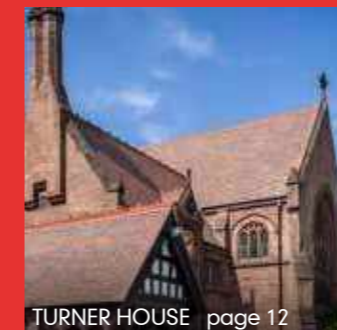

TURNER HOUSE page 12



ELVEDEN TREEHOUSES page 14



QUINTAIN HOUSE page 16

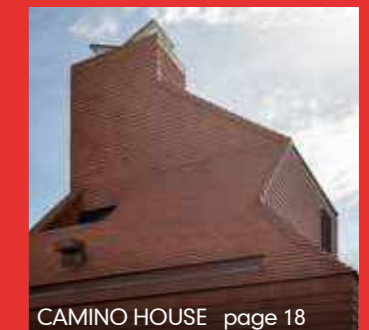

CAMINO HOUSE page 18



GOLDEN MEDE

Location
Waddesdon, Bucks

Application
Residential

Product
Acme Double Camber
clay plain tiles in Burnt
Flame

Architect
C.F. Moller



BACKWATER

Location
Norfolk Broads

Application
Residential

Product
Western Red Cedar Shingles

Architect
Platform 5



RETIREMENT VILLAGE

Location
Wixams, Bedfordshire

Application
Healthcare
Residential

Product
Edgemere interlocking slates
and concrete plain tiles

Developer
Galliford Try





PINE LAKE

Location
Midlands

Application
Residential

Product
Edgemere interlocking
slates in Smooth Grey

Specifier
Foundation Matters





TURNER HOUSE

Location
Liverpool

Application
Residential
Healthcare
Grade II listed

Product
Acme Double Camber clay
plain tiles in Dark Brindle

ELVEDEN TREEHOUSES

Location

Elveden Forest

Application

Leisure

Product

Western Red Cedar Shingles

Sub-contractor

Lodge Roofing



QUINTAIN HOUSE

Location
Gloucestershire

Application
Residential

Product
Acme Double Camber plain tiles
in Burnt Flame

Specifier
Kirkland Fraser Moor



CAMINO HOUSE

Location
Perth, Australia

Application
Residential

Product
Acme Single Camber clay plain
tiles in Red Smooth

Architect
Bosske



The Marley roof system

We offer the most comprehensive roof system on the market today, underwritten by a 15 year warranty.

Our complete, one-source roof system, gives levels of accountability and product integration that reduce specifier and contractor design and installation liability.

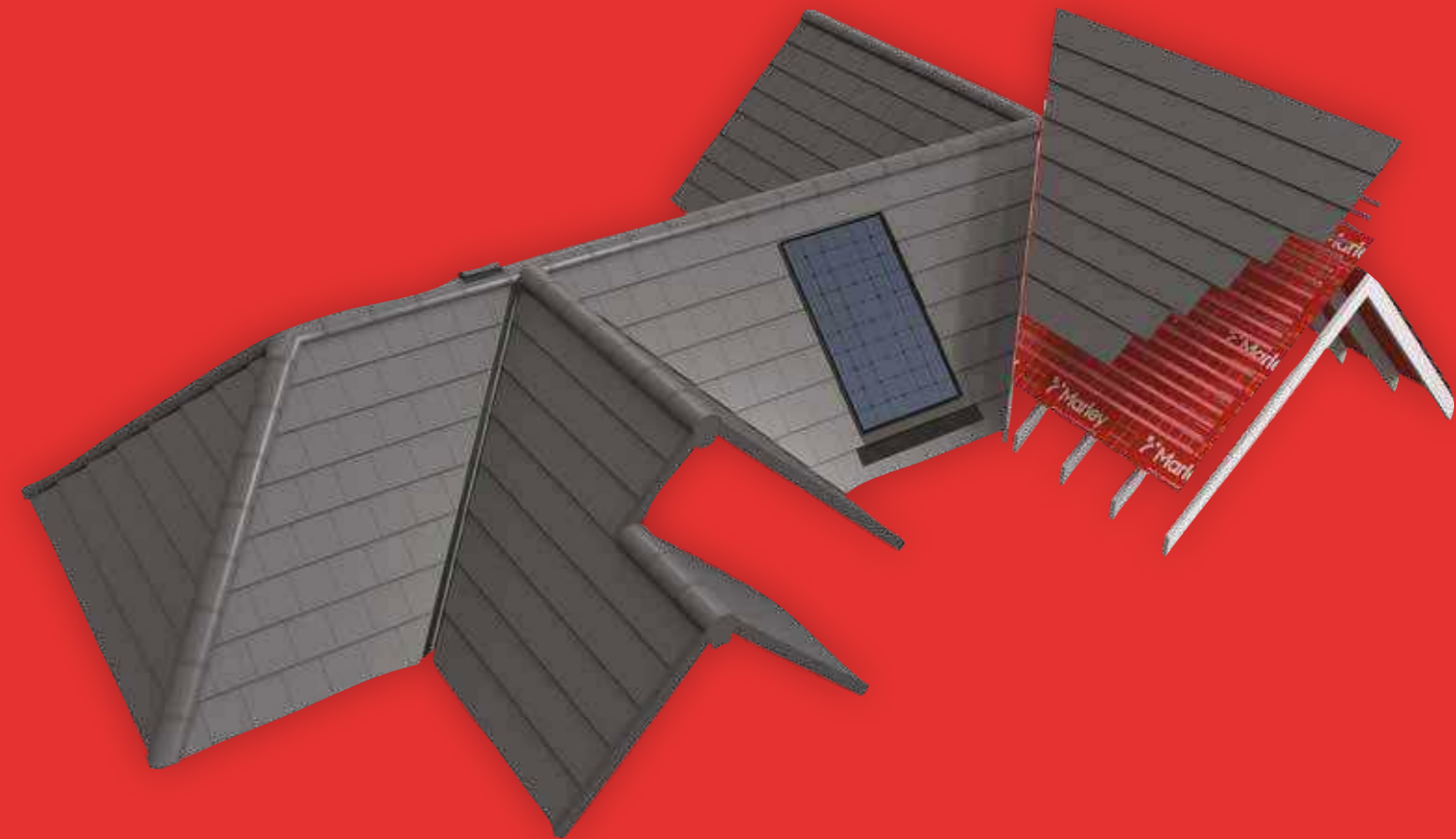

The Marley roof system

More elements guaranteed to work seamlessly together, giving you more time to focus on design and management of your project.

Choose the Marley roof system for complete peace of mind and of course, more durable, lower maintenance roofs.

01/ BASE LAYERS

With Universal vapour permeable or non-breathable fully taped underlay and JB Red pre-graded BBA-certified battens, we offer BS 5534 compliant NHBC approved base layers that work seamlessly with all the other elements of our roof systems.

- ▲ Universal underlays (page 27)
- ▲ JB Red battens (page 29)

02/ ROOF COVERINGS

A range of concrete and clay tiles, and solar panels to suit every sector, pitch, geographical location and aesthetic requirement: at the same time complying with BS 5534 and BS 5250 and fully integrating with our base layers and dry fix systems to create a complete roof system.

- ▲ Clay plain tile range (page 32)
- ▲ Clay profiled tile range (page 60)
- ▲ Concrete tile range (page 68)
- ▲ Shingles and Shakes (page 100)
- ▲ Marley SolarTile® (page 24)

03/ DETAILING

Dry fix BS 5534, BS 8612 and BS 5250 compliant systems for eaves, verge, valley hip, ridge abutment and other areas. These systems are made from high quality materials and tested together to work with our range of roof coverings to give secure, weathertight and durable finishing and detailing for our roof systems.

- ▲ Dry fix and ventilation systems
- ▲ Fittings and accessories
- ▲ Design details (page 141)

KNOWLEDGE

A key part of our roof system is ease of access to tools and knowledge that make the design, specification and fixing process easier and faster. Our suite of free-to-use online tools is designed to get our knowledge into your designs and specs quickly and easily.

- ▲ Resources (page 194)

WHAT A ROOF SYSTEM MEANS FOR YOU

- ▲ A bespoke specification, produced quickly and easily for every project
- ▲ Maximum protection of your design liability – all of our system elements are designed and tested to work seamlessly together
- ▲ You deal with one supplier who takes responsibility for everything – freeing up your time to manage the project
- ▲ Clear and comprehensive specifications – giving you the greatest possible control over the supply chain and installation
- ▲ Assured quality standards from the market-leaders in roof systems
- ▲ A full 15 year system guarantee for real peace of mind

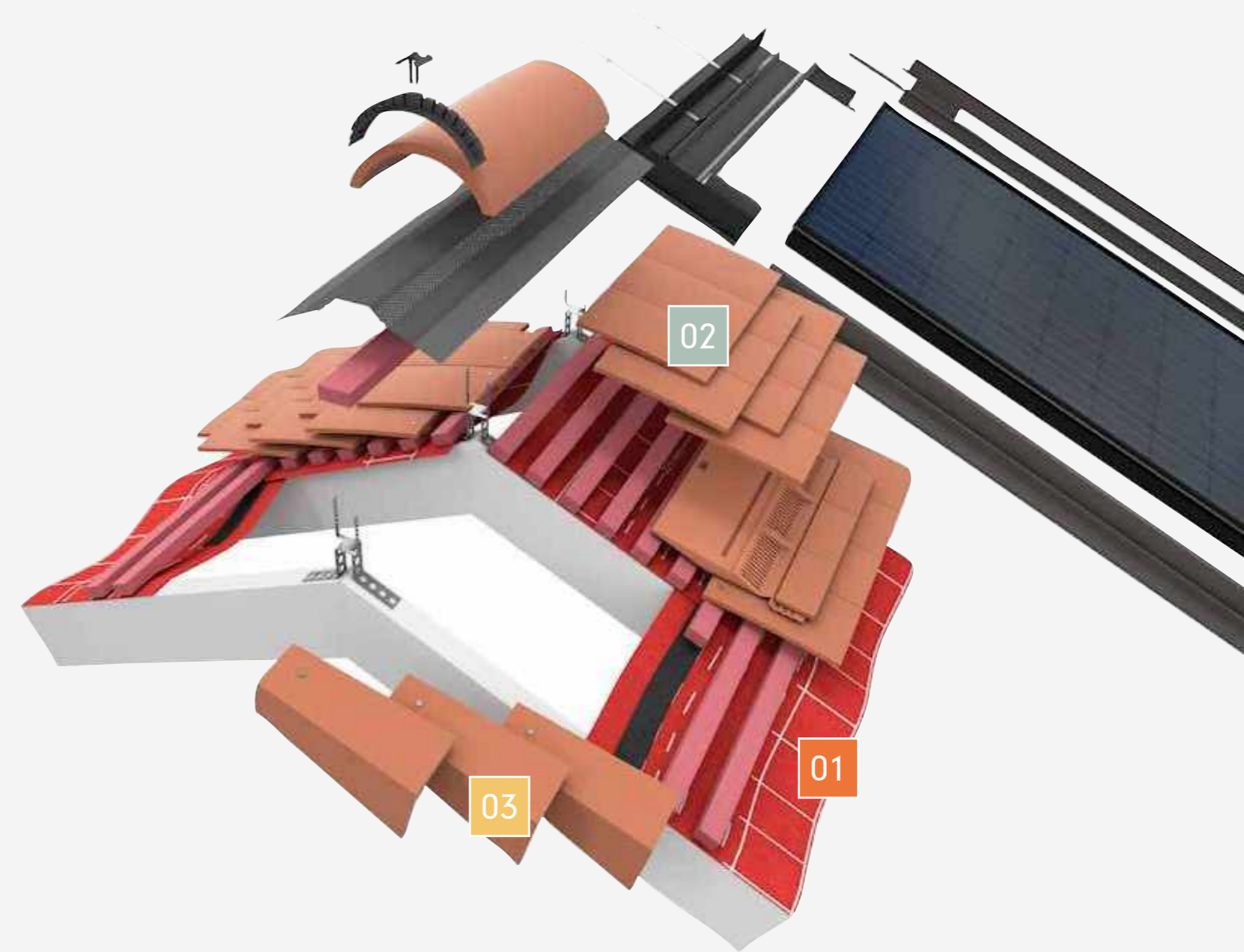

WARRANTY

Our 15 year warranty covers more pitched roofing elements than any other manufacturer and gives the ultimate assurance that our integrated roofing solutions can be specified and installed with complete confidence.

- ▲ For more information visit marley.co.uk/roofsystem

MARLEY SOLAR®

LOW PROFILE, INTEGRATED SOLAR PANELS

Marley SolarTile® is a roof integrated solar panel that replaces the tiles on the roof, so they sit lower in the roofline, look more like a part of the building design and deliver a more attractive aesthetic.

Product performance is always key when selecting building products and Marley SolarTile® does not disappoint, achieving exceptional fire performance, wind resistance and weather tightness without the need for extra roof battens, adhesive flashing rolls or fire proofing materials.

High winds are always a consideration for roofing applications, Marley SolarTile® has a certified wind resistance more than four times greater than other products on the market, without any modification to the roof structure below and can even be used in exposed locations, giving you peace of mind that the product you choose is of the highest specification.

Solar power has developed into an in-demand home improvement requirement, with the genuine cost-saving benefits of using renewable energy to help power our homes. Add to this, the sleek aesthetics of Marley SolarTile® and true kerb appeal can be added to long-lasting, maintenance-free performance.

- ▲ Integrates with the full Marley roof system and all tile types
- ▲ Generates renewable energy to reduce household bills
- ▲ Very low profile and unobtrusive
- ▲ Lightweight, compact and simple to install
- ▲ Market-leading fire performance*
- ▲ Exceptional industry leading wind resistance performance
- ▲ 15 year guarantee as part of the Marley Roof System

**15
YEAR**

**MARLEY ROOFING
SYSTEM WARRANTY**



TYPICAL DESIGN DETAILS

HEAD DETAIL

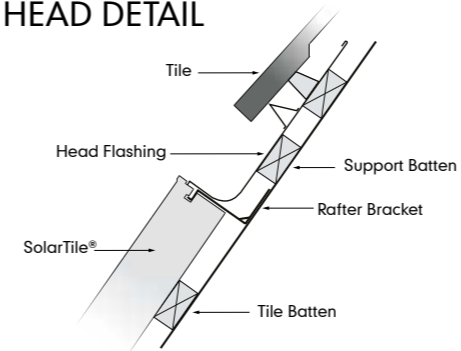

JOIN DETAIL

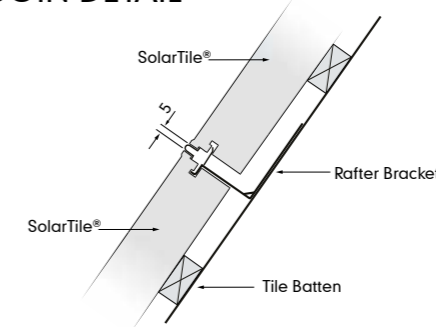

SILL DETAIL

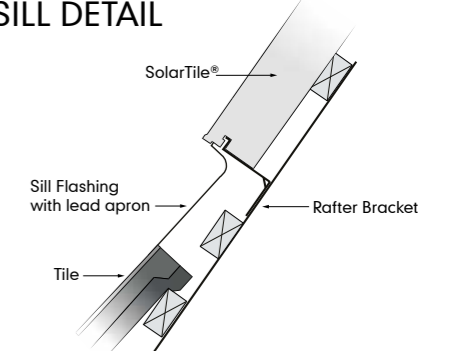

SIDE DETAIL

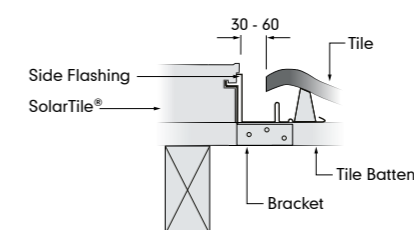

GUTTER DETAIL

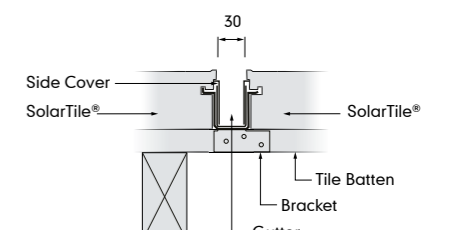

Solar Configurator

Use the Marley Configurator to build the array of solar panels and roofing kits for any roof. The configurator also calculates the kWp output, so you can easily achieve the correct size and performance of system.

marley.co.uk/solar

* Marley SolarTile® is Clearline Fusion, a Viridian Solar product and the only roof-integrated solar system accredited with the highest resistance to spread of flame and fire penetration in all European fire tests.

Base layers

- 27 UNIVERSAL VAPOUR PERMEABLE UNDERLAY
- 28 UNIVERSAL NON-BREATHABLE UNDERLAY
- 29 JB RED BATTENS
- 29 MARLEY ROOF DEFENCE
- 30 SPECIALITY BATTENS

BASE LAYERS UNDERLAYS FOR ROOF SYSTEMS

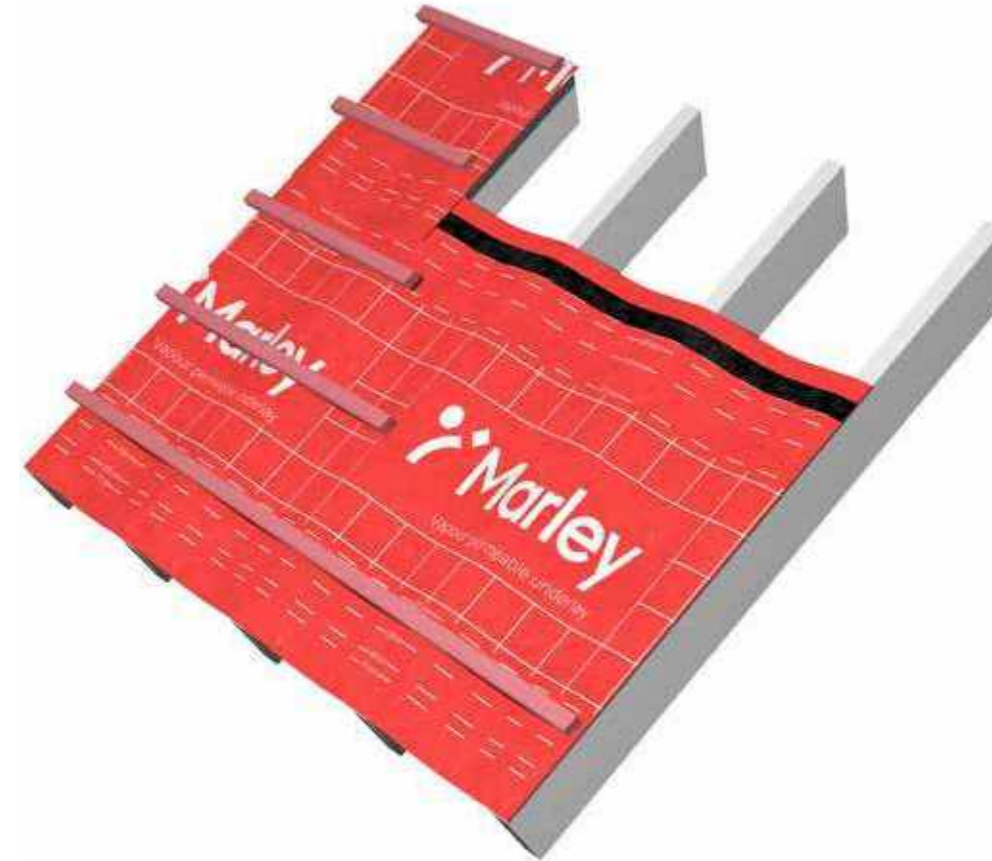

UNIVERSAL VAPOUR PERMEABLE UNDERLAY

Universal vapour permeable underlay is a high performance breathable membrane for pitched roofs. Supplied in 1m x 50m rolls with integrated tape for sealing laps, the underlay is fully compliant to BS 5534 and suitable for all UK wind zones 1-5.

Universal vapour permeable underlay is designed to integrate seamlessly within a full Marley roof system and provides an additional means of ventilation to meet the requirements of BS 5250*.

Dimensions

50m long x 1m wide
170gm/m²

Benefits

- ▲ Vapour permeable
- ▲ High tensile and tear strength
- ▲ Clean and easy to handle
- ▲ Durable
- ▲ UV resistant
- ▲ BBA approved – Certificate No. 19/5678
- ▲ Integrated tape for sealing laps
- ▲ Guidance lines for minimum laps
- ▲ UK manufactured

* Consideration must be given to the type of roof covering used, which will influence the ventilation requirements. For further information, please contact the Marley Technical Advisory Service.

Minimum overlaps

ROOF PITCH	HORIZONTAL LAPS		VERTICAL LAPS
	Not fully supported	Fully supported	
12.5° to 14°	225mm	150mm	100mm
>15°	150mm	100mm	100mm

Zonal classifications for underlays

Product	Universal vapour permeable underlay
Identification	Code MA33150
Manufacturer	Marley Limited
Batten gauge	≤345mm with integrated taped laps
Declared wind uplift resistance P _d	>1600pa
Zone suitability	1 to 5

BASE LAYERS

UNDERLAYS FOR ROOF SYSTEMS

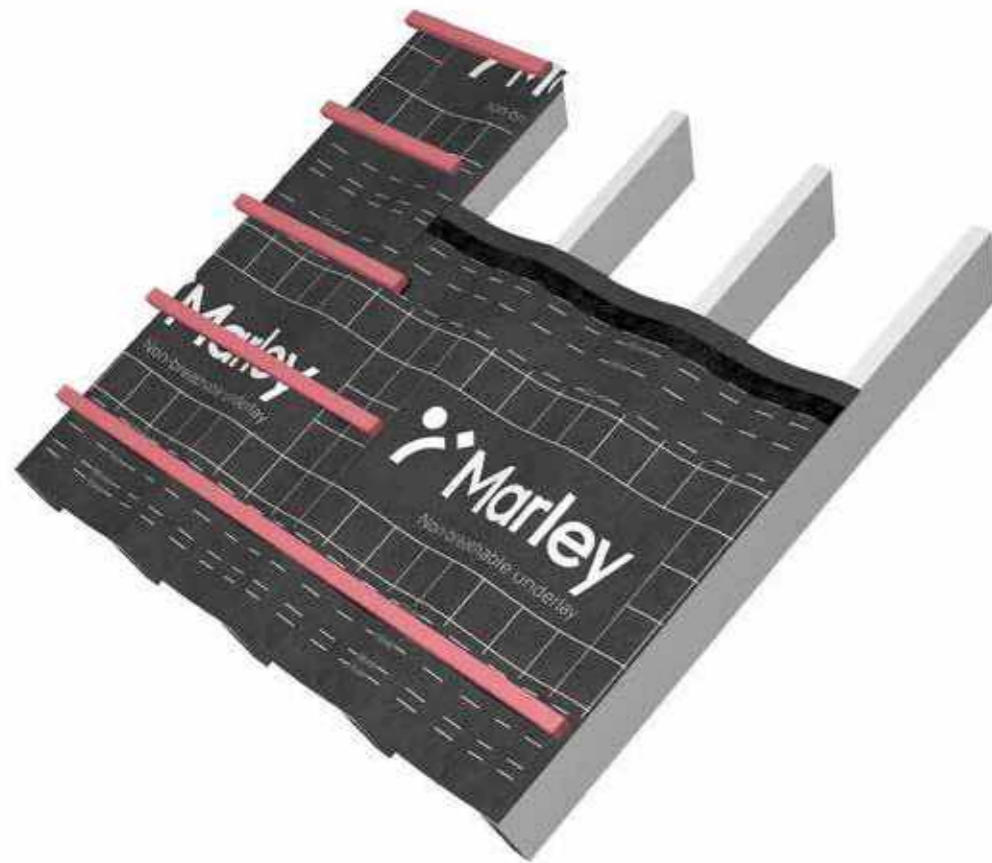

UNIVERSAL NON-BREATHABLE UNDERLAY

Universal non-breathable underlay is a lightweight, high performance membrane for pitched roofs. Supplied in 1m x 45m rolls with integrated tape for sealing laps, the underlay is fully compliant to BS 5534 and suitable for all UK wind zones 1-5.

Universal non-breathable underlay is designed to integrate seamlessly within a full Marley roof system and is suitable for roofs with traditional ventilation products.

Dimensions

45m long x 1m wide
116gm/m²

Benefits

- ▲ Non-breathable
- ▲ High tensile and tear strength
- ▲ Clean and easy to handle
- ▲ Durable
- ▲ UV resistant
- ▲ BBA approved – Certificate no. 19/5673
- ▲ Lightweight alternative to traditional type IF
- ▲ Integrated tape for sealing laps
- ▲ Guidance lines for minimum laps
- ▲ UK manufactured

Minimum overlaps

ROOF PITCH	HORIZONTAL LAPS		VERTICAL LAPS
	Not fully supported	Fully supported	
12.5° to 14°	225mm	150mm	100mm
>15°	150mm	100mm	100mm
35°+	100mm	75mm	150mm

Zonal classifications for underlays

Product	Universal non-breathable underlay
Identification	Code MA33145
Manufacturer	Marley Limited
Batten gauge	≤345mm with integrated taped laps
Declared wind uplift resistance P _d	2306pa
Zone suitability	1 to 5

BASE LAYERS

BATTENS FOR ROOF SYSTEMS

JB RED

JB Red is a high quality roofing batten and the first fully pre-graded batten available to the roofing industry.

JB Red completely meets the NHBC requirements for fully graded roofing battens. Its RED colour means that it is highly visible on site, therefore Local Authority Building Control, NHBC and other inspectors can see that high quality, pre-graded and compliant battens have been used.

All JB Red has full chain of custody and is available in both 25 x 38mm and 25 x 50mm sizes.

Benefits

- ▲ JB red is pre-graded to meet all the strength requirements of BS 5534 for roofing battens
- ▲ Battens marked to show manufacturers name, species, grade and size
- ▲ The product and process is UKAS third party assessed by the BBA with a BBA Agrément Certificate No. 19/5668
- ▲ JB Red is LABC registered and is approved for use by local authorities.
- ▲ UK manufactured
- ▲ Manufactured to comply with BS 5534 from slow grown, high grade timber, selected from the approved species within.
- ▲ BS 5534, European Redwood (PNSY) or European Whitewood (WPCA).
- ▲ Only kiln-dried sideboards are used to ensure stability and dimensional accuracy.
- ▲ Treated to BS 8417 Usage Class 2, using Koppers MicroPro® with a unique Red Colour.
- ▲ Carries 60 year lifetime expectancy against insect attack and wood rotting fungi (when installed correctly in accordance with the requirements of Usage Class 2).
- ▲ Packaged in easy to handle bundles of 10.



BATTEN END CLIPS

These are for use with all dry verge units. Easily fitted to the batten end, they provide easy, fast and positive fixing of dry verge units to the batten end. Compliant with BS 8612.

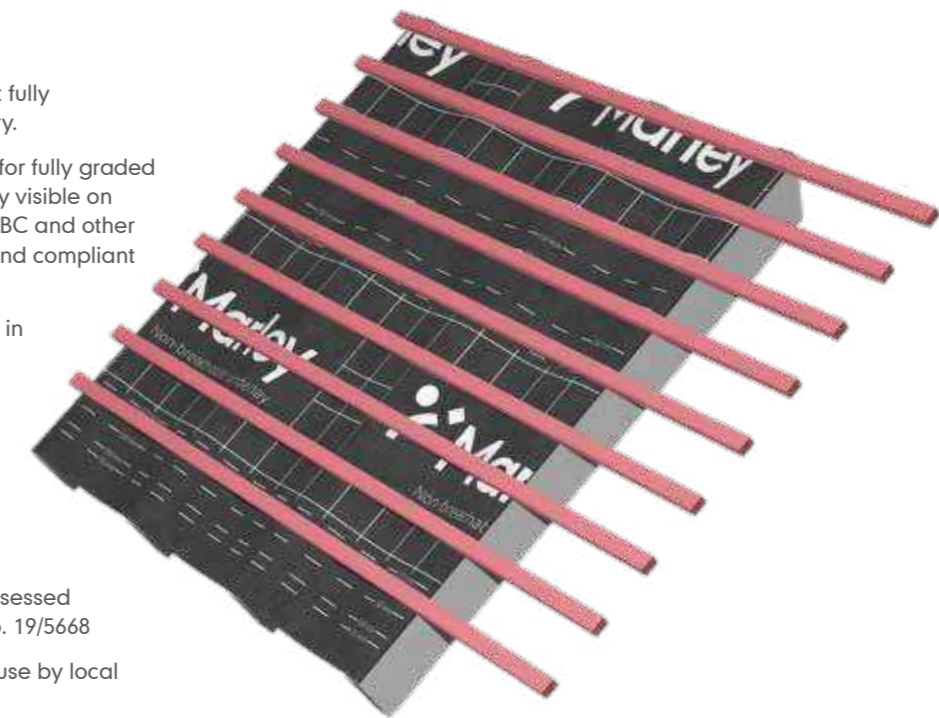

▲ MARLEY ROOF DEFENCE

Marley Roof Defence is an intumescent roof fire barrier installed under tiles and between roofing battens to help prevent the spread of fire and smoke between adjoining properties in semi-detached and terraced houses.

It provides full fire protection from one roof to the next, achieving up to a 60 minute fire rating, and can also be used as a fire barrier in large roofs, or as a fire break in buildings such as schools, care homes and hospitals.

Find out more marley.co.uk/roofdefence

Coming soon

BASE LAYERS

SPECIALITY BATTENS

Marley offer a range of roofing timbers above truss or rafter level.

JB GREEN

A premium, Type A timber batten for use in a wide range of applications.

- ▲ Made from slow-grown, kiln-dried timber
- ▲ All material carries full chain of custody certification
- ▲ Preservative green treated to Usage Class 2
- ▲ Available in lengths 3.6 - 5.4m
- ▲ Not suitable for BS 5534 applications*

Batten Size (mm)	Pieces per bundle	Bundles per pack	Total pieces per pack
19 x 38	10	70	700
19 x 50	10	55	550
25 x 38	10	56	560
25 x 50	10	44	440

* For BS 5534 graded batten applications, see JB Red.

COUNTERBATTENS

This range includes alternative batten sizes often needed when matching in with existing battens or when used over wide rafter centres. Counterbatten include both large and small section battens. We can manufacture accurately as small as 6 x 25mm. The sizes used often vary around the country. The small section battens 6 x 25mm to 13 x 50mm are only available in 3.0m lengths from stock (other lengths to order).





Batten Size (mm)	Pieces per bundle	Bundles per pack	Total pieces per pack
6 x 25	100	8	800
10 x 38	24	14	336

LARGE SECTION ROOFING AND NON-STANDARD BATTENS

Batten Size (mm)	Pieces per bundle	Bundles per pack	Total pieces per pack
25 x 100	6	12	72
38 x 50	6	10	60
47 x 50	6	8	48



SPECIALITY BATTENS

Batten Size (mm)	Pieces per bundle	Bundles per pack	Total Pieces per pack
 50 x 50 Corner-to-corner		12	8 96
 50 x 50 Lead Roll	60	1	60
 38 x 50 Zinc Roll	60	1	60
 50 x 50 Firing	12	8	96
 75 x 75 King Roll	24	1	24

The sizes used often vary around the country. The battens are only available in 3.0m lengths from stock (other lengths to order).

Roof coverings

CLAY PLAIN TILES	32
CLAY INTERLOCKING TILES	60
CONCRETE TILES	68
SHINGLES & SHAKES	100

Clay plain tiles

Plain tiles made from clay have been used to cover roofs in Britain for over eight hundred years and they form much of the character of the roofs seen in the South East of England and the Midlands, where the largest deposits of clay are located.

Our extensive range is manufactured from the finest Etruria Marl and contains colour, texture and camber options which meet the aesthetic and performance demands of all types of roofing applications.

WHY CHOOSE CLAY PLAIN TILES?

- ▲ Beautiful, durable, natural material
- ▲ BES 6001 'Excellent'
- ▲ A+ rated in the BRE Green Guide*
- ▲ Comprehensive range of colours and finishes
- ▲ 30° low pitch options
- ▲ Traditional range of fittings and accessories
- ▲ Carbon footprint certification
- ▲ Market-leading brands
- ▲ Manufactured from Etruria Marl
- ▲ Responsibly sourced

CLAY PLAIN TILES RANGE

- ▲ Canterbury (page 34)
- ▲ Ashdowne (page 38)
- ▲ Hawkins (page 42)
- ▲ Acme Double Camber (page 46)
- ▲ Acme Single Camber (page 50)

* Element ref: 812410006

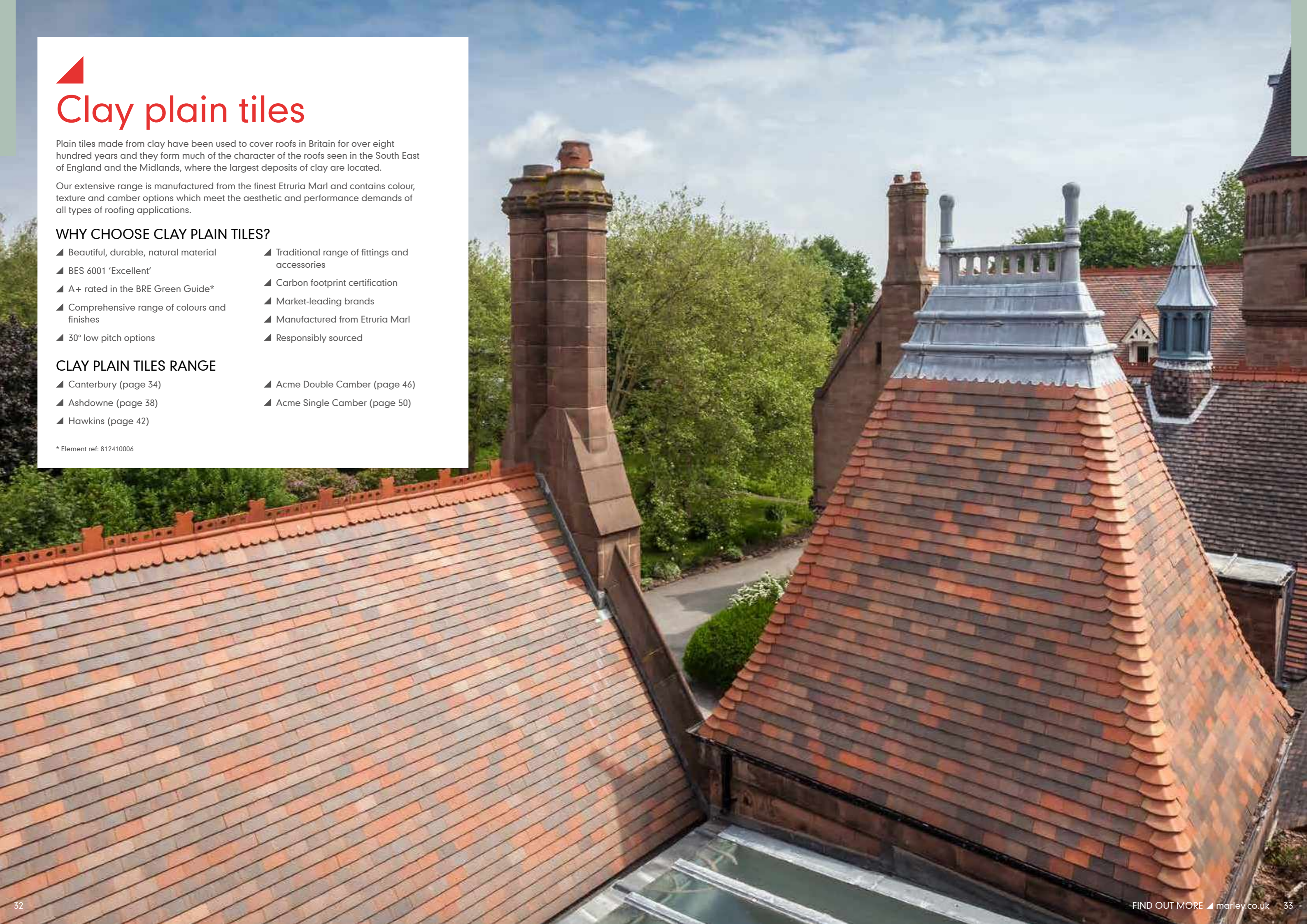

CANTERBURY HANDMADE
CLAY PLAIN TILES



CANTERBURY HANDMADE CLAY PLAIN TILES

Nothing compares to handmade clay roof tiles. The character, the durability and, of course, the beauty. It's something that can't be replicated.



CLAY HANDMADE FEATURE TILES

Tile camber
Single camber

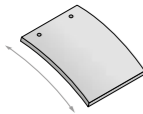

Feature tiles

For advice on the use of feature tiles in main roof areas, contact the Technical Advisory Service.



Bullnose



Club

SUSTAINABILITY

Green guide rating** A+

BES 6001 Excellent

** Element Ref: 812410006

TECHNICAL DATA

Size of tile	265mm x 165mm	
Minimum pitch*	40°	
Maximum pitch	90°	
Minimum headlap	Roof	65mm
	Vertical	35mm
Maximum gauge	Roof	100mm
	Vertical	115mm
Tile thickness	13mm (nominal)	
Cover width	165mm (nominal)	
Covering capacity (net)	Roof	60 tiles/m ² at 100mm gauge
	Vertical	53 tiles/m ² at 115mm gauge
Weight of tiling (approx.)	Roof	74kg/m ² (0.73 kN/m ²) at 100mm gauge
	Vertical	66kg/m ² (0.64 kN/m ²) at 115mm gauge
Battens required (net)	Roof	10.0 lin.m/m ² at 100mm gauge
	Vertical	8.7 lin.m/m ² at 115mm gauge
Batten size recommended (fixed to BS 5534)	38 x 25mm for rafters/supports not exceeding 600mm centres	
Tile nails	38mm x 2.65mm	
Authority	BS EN 1304	

* The minimum recommended pitch and lap may be influenced by special circumstances, please contact the Technical Advisory Service for further information.

Clay is a natural product and as such, variation in colour and texture can occur.



Loxleigh (fine sanded finish)



Location: Denham, Application: residential, Product: Canterbury Handmade Clay Plain Tile, Specifier: Self Build

ASHDOWNE HANDCRAFTED
CLAY PLAIN TILES



Location: Thatcham Application: Healthcare Product: Ashdowne clay plain tiles in Ashurst Specifier: Sovereign Housing Association

ASHDOWNE HANDCRAFTED CLAY PLAIN TILES

Handcrafted clay plain tiles offer a warm, mellow appearance, with a granular texture and slight random irregularities that make each tile unique.



CLAY HANDCRAFTED FEATURE TILES

Tile camber
Single camber

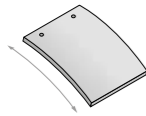

Feature tiles

Available in a range of colours. For advice on the use of feature tiles in main roof areas, contact the Technical Advisory Service.



Bullnose



Club

SUSTAINABILITY

Green guide rating** A+

BES 6001 Excellent

** Element Ref: 812410006

TECHNICAL DATA

Size of tile	265mm x 165mm	
Minimum pitch*	35°	
Maximum pitch	90°	
Minimum headlap	Roof	65mm
	Vertical	35mm
Maximum gauge	Roof	100mm
	Vertical	115mm
Tile thickness	11mm (nominal)	
Cover width	165mm (nominal)	
Covering capacity (net)	Roof	60 tiles/m ² at 100mm gauge
	Vertical	53 tiles/m ² at 115mm gauge
Weight of tiling (approx.)	Roof	65kg/m ² (0.64 kN/m ²) at 100mm gauge
	Vertical	57kg/m ² (0.56 kN/m ²) at 115mm gauge
Battens required (net)	Roof	10.0 lin.m/m ² at 100mm gauge
	Vertical	8.7 lin.m/m ² at 115mm gauge
Batten size recommended (fixed to BS 5534)	38 x 25mm for rafters/supports not exceeding 600mm centres	
Tile nails	38mm x 2.65mm	
Authority	BS EN 1304	

* The minimum recommended pitch and lap may be influenced by special circumstances, please contact the Technical Advisory Service for further information.

Clay is a natural product and as such, variation in colour and texture can occur.



Location: Stanmore Application: Residential Product: Ashdowne clay plain tiles in Aylesham Mix Specifier: Signia Homes



Ashurst (sanded finish)



Aylesham Mix (sanded finish)

HAWKINS
CLAY PLAIN TILES



Location: Stratford upon Avon Application: Residential Product: Hawkins clay plain tiles in Fired Sienna Specifier: Greenall Construction

HAWKINS

CLAY PLAIN TILES

The name 'Hawkins' has been synonymous with quality roofs for over 150 years. This heritage, combined with modern firing techniques, gives a unique colour range.



CLAY FEATURE TILES

Tile camber
Single camber

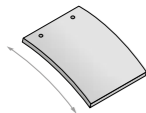

Feature tiles

Available in a range of colours. For advice on the use of feature tiles in main roof areas, contact the Technical Advisory Service.



Bullnose



Club

SUSTAINABILITY

Green guide rating** A+

BES 6001 Excellent

** Element Ref: 812410006

TECHNICAL DATA

Size of tile	265mm x 165mm	
Minimum pitch*	30°	
Maximum pitch	90°	
Minimum headlap	Roof	65mm
	Vertical	35mm
Maximum gauge	Roof	100mm
	Vertical	115mm
Tile thickness	11mm (nominal)	
Cover width	165mm (nominal)	
Covering capacity (net)	Roof	60 tiles/m ² at 100mm gauge
	Vertical	53 tiles/m ² at 115mm gauge
Weight of tiling (approx.)	Roof	64kg/m ² (0.63 kN/m ²) at 100mm gauge
	Vertical	56kg/m ² (0.55 kN/m ²) at 115mm gauge
Battens required (net)	Roof	10.0 lin.m/m ² at 100mm gauge
	Vertical	8.7 lin.m/m ² at 115mm gauge
Batten size recommended (fixed to BS 5534)	38 x 25mm for rafters/supports not exceeding 600mm centres	
Tile nails	38mm x 2.65mm	
Authority	BS EN 1304	

* The minimum recommended pitch and lap may be influenced by special circumstances, please contact the Technical Advisory Service for further information.

Clay is a natural product and as such, variation in colour and texture can occur.



Staffordshire Blue (fine sanded finish)



Staffordshire Mix (fine sanded finish)



Fired Sienna (textured finish)



Blue Smooth (smooth finish)



Dark Heather (fine sanded finish)

ACME DOUBLE CAMBER
CLAY PLAIN TILES



Location: Liverpool Application: Healthcare Product: Acme Double Camber (Dark Brindle)

ACME DOUBLE CAMBER CLAY PLAIN TILES

Acme double camber clay plain tiles have both a longitudinal and latitudinal camber, accentuating light and shade, creating highly textured roofscapes.



CLAY FEATURE TILES

Tile camber
Double camber



Feature tiles
Available in a range of colours. For advice on the use of feature tiles in main roof areas, contact the Technical Advisory Service.

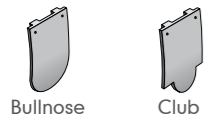

SUSTAINABILITY

Green guide rating** A+
BES 6001 Excellent

** Element Ref: 812410006

TECHNICAL DATA

Size of tile	265mm x 165mm	
Minimum pitch*	35°	
Maximum pitch	90°	
Minimum headlap	Roof	65mm
	Vertical	35mm
Maximum gauge	Roof	100mm
	Vertical	115mm
Tile thickness	11mm (nominal)	
Cover width	165mm (nominal)	
Covering capacity (net)	Roof	60 tiles/m ² at 100mm gauge
	Vertical	53 tiles/m ² at 115mm gauge
Weight of tiling (approx.)	Roof	64kg/m ² (0.63 kN/m ²) at 100mm gauge
	Vertical	56kg/m ² (0.55 kN/m ²) at 115mm gauge
Battens required (net)	Roof	10.0 lin.m/m ² at 100mm gauge
	Vertical	8.7 lin.m/m ² at 115mm gauge
Batten size recommended (fixed to BS 5534)	38 x 25mm for rafters/supports not exceeding 600mm centres	
Tile nails	38mm x 2.65mm	
Authority	BS EN 1304	

* The minimum recommended pitch and lap may be influenced by special circumstances, please contact the Technical Advisory Service for further information.

Clay is a natural product and as such, variation in colour and texture can occur.



ACME SINGLE CAMBER
CLAY PLAIN TILES



Location: Swansea Application: Residential Product: Acme Single Camber clay plain tiles in Grey Sandfaced Specifier: Huw Griffiths Architects

ACME SINGLE CAMBER CLAY PLAIN TILES

The Acme single camber clay plain tile allows the creation of traditional and contemporary low pitch roof designs with the warmth and character of clay.



CLAY FEATURE TILES

Tile camber
Single camber

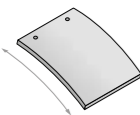

Feature tiles

Available in a range of colours. For advice on the use of feature tiles in main roof areas, contact the Technical Advisory Service.



Bullnose



Club

SUSTAINABILITY

Green guide rating** A+

BES 6001 Excellent

** Element Ref: 812410006

TECHNICAL DATA

Size of tile	265mm x 165mm	
Minimum pitch*	30°	
Maximum pitch	90°	
Minimum headlap	Roof	65mm
	Vertical	35mm
Maximum gauge	Roof	100mm
	Vertical	115mm
Tile thickness	11mm (nominal)	
Cover width	165mm (nominal)	
Covering capacity (net)	Roof	60 tiles/m ² at 100mm gauge
	Vertical	53 tiles/m ² at 115mm gauge
Weight of tiling (approx.)	Roof	64kg/m ² (0.63 kN/m ²) at 100mm gauge
	Vertical	56kg/m ² (0.55 kN/m ²) at 115mm gauge
Battens required (net)	Roof	10.0 lin.m/m ² at 100mm gauge
	Vertical	8.7 lin.m/m ² at 115mm gauge
Batten size recommended (fixed to BS 5534)	38 x 25mm for rafters/supports not exceeding 600mm centres	
Tile nails	38mm x 2.65mm	
Authority	BS EN 1304	

* The minimum recommended pitch and lap may be influenced by special circumstances, please contact the Technical Advisory Service for further information.

Clay is a natural product and as such, variation in colour and texture can occur.



Heather Sandfaced (fine sanded finish)



Century (smooth finish)



Grey Sandfaced (fine sanded finish)



Farmhouse Brown Sandfaced (fine sanded finish)



Heather Blend (fine sanded finish)



Mixed Brindle (smooth finish)



Red Sandfaced (fine sanded finish)



Red Smooth (smooth finish)

QUINTAIN HOUSE CASE STUDY

“The undulating roofline of the Quintain House disguises the complex and challenging roofing structure underneath. Marley’s Acme Double Camber clay tiles deliver a highly textured, curved and seamless finish that highlights the roof’s dramatic rise and fall, pushing the boundaries of traditional roofing. The result is a unique building that fits in with houses in nearby traditional villages, and exudes beauty and comfort.”

ANDREW ROWLANDS, ROOFING CONTRACTOR, ROWLANDS ROOFING

PROJECT INFORMATION

Location
Gloucestershire

Application
Residential

Product
Acme Double Camber
in Burnt Flame

Specifier
Kirkland Fraser Moor

Quintain House’s clay tiled roof is sympathetic to those in traditional villages in the surrounding area.

Its striking undulating form was very challenging on a technical level and was achieved using Acme Double Camber clay plain tiles in Burnt Flame, demonstrating their versatility in creating complex roof designs.

▲ Find more case studies at marley.co.uk/case-studies

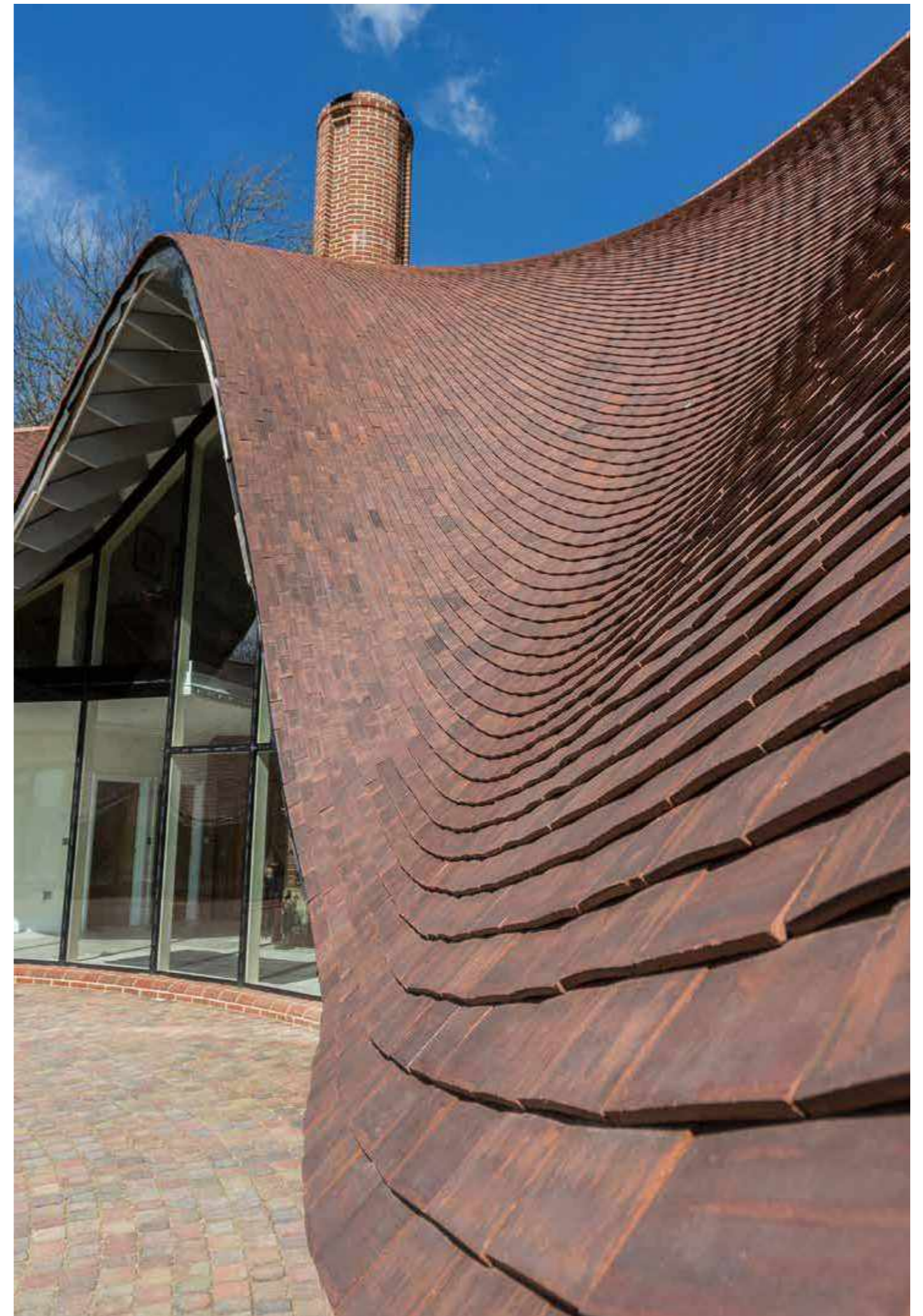

FITTINGS & ACCESSORIES

FOR CLAY PLAIN TILES

Marley manufacture a wide range of clay plain tile fittings, decorative ridges and finials. All products can be installed in line with the latest BS 5534 'Code of Practice for Slating and Tiling' and NHBC Technical Standards.

Important note: All the fittings shown on these pages can be used with clay plain tiles, but should not be used on rafter pitches below 35° with Acme double camber or Ashdowne handcrafted clay plain tiles.

PLAIN TILE FITTINGS

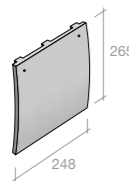
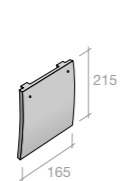
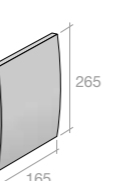
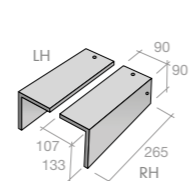
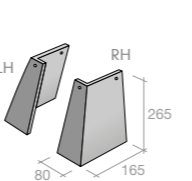
					
Description	Tile-and-a-half	Eaves/top tile	Creasing tiles§	Cloaked verge tiles*	External angle tiles
Angles available	n/a	n/a	n/a	n/a	90°, 135°

RIDGE TILES

Mortar bedded security ridge kits are available (see page 125)

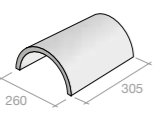
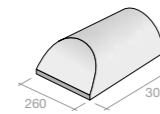
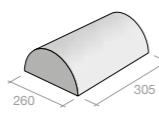
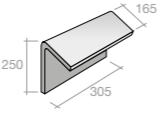
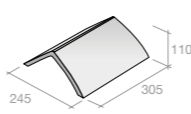
					
Description	Half round ridge	Half round ridge hip end*	Half round ridge stop end*	Mono ridge*	Hogs back ridge**
Colours available	All colours	All colours	All colours	All colours	Burnished
Pitch range	30-60°	30-60°	30-60°	30-45°	30-45°

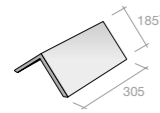
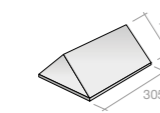
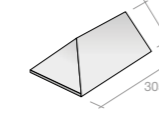
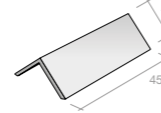
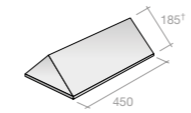
					
Description	305mm Angular ridge**	305mm Angular ridge stop end*	305mm Angular ridge hip end*	450mm Angular ridge	450mm Angular ridge stop end*
Angles available	90°, 105°	90°, 105°	90°, 105°	75°, 90°, 105°, 115°, 125°, 135°	75°, 90°, 105°, 115°, 125°, 135°
Colours available	All colours	All colours	All colours	Red Smooth, Slate Black	Red Smooth, Slate Black
Pitch range	See Tables 1, 3, 4, 5 & 6 (page 179)	See Tables 1, 3, 4, 5 & 6 (see page 179)	See Tables 1, 3, 4, 5 & 6 (see page 179)	See Tables 1, 3, 4, 5 & 6 (see page 179)	See Tables 1, 3, 4, 5 & 6 (see page 179)

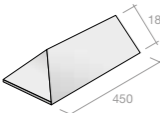
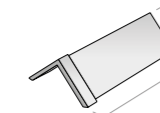
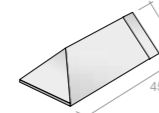
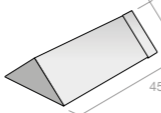
				
Description	450mm Angular ridge hip end*	450mm Capped angular ridge	450mm Capped angular ridge hip end	450mm Capped angular ridge stop end
Angles available	75°, 90°, 105°, 115°, 125°, 135°	75°, 90°, 105°, 115°, 125°, 135°	75°, 90°, 105°, 115°, 125°, 135°	75°, 90°, 105°, 115°, 125°, 135°
Colours available	Red Smooth, Slate Black	Red Smooth, Slate Black, Staffordshire Blue†	Red Smooth, Slate Black, Staffordshire Blue†	Red Smooth, Slate Black, Staffordshire Blue†
Pitch range	See Tables 1, 3, 4, 5 & 6 (see page 179)	See Tables 1, 3, 4, 5 & 6 (see page 179)	See Tables 1, 3, 4, 5 & 6 (see page 179)	See Tables 1, 3, 4, 5 & 6 (see page 179)

FEATURE TILES

Available in a range of colours, please contact customer services for more information.

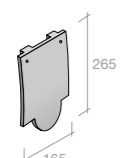
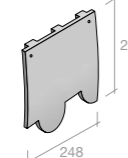
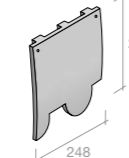
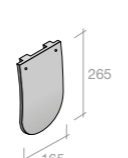
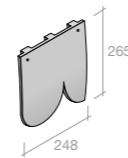
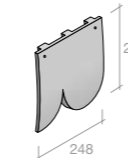
						
Description	Club feature tile*	RH club tile-and-a-half*	LH club tile-and-a-half*	Bullnose feature tile*	RH bullnose tile-and-a-half*	LH bullnose tile-and-a-half*

HIPS AND VALLEYS

Mortar bedded security hip kits are available for third round ridges (see page 125)

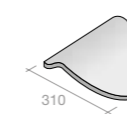
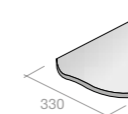
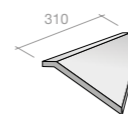
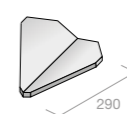
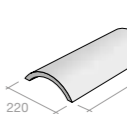
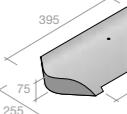
						
Description	Granny bonnet hip	Semi bonnet hip	Arris hip**	Valley**	Third round hip**	Third round hip end**
Angles available	n/a	n/a	130°, 135°, 145°	130°, 135°, 140°, 145°, 150°	n/a	n/a
Pitch range	40-60°	30-40°	30-45°	30-50°	30-45°	30-45°



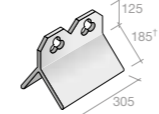
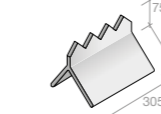
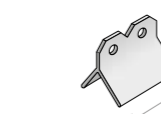

DECORATIVE RIDGES

Mortar bedded security ridge kits are available (see page 125)

			
Description	Club crested ridge	Cocks comb crested ridge	Two hole crested ridge
Angles available	90°, 105°	90°, 105°	90°, 105°
Colours available	Red Smooth	Red Smooth	Red Smooth
Pitch range	See Tables 1, 3, 4, 5 & 6 (see page 179)	See Tables 1, 3, 4, 5 & 6 (see page 179)	See Tables 1, 3, 4, 5 & 6 (see page 179)

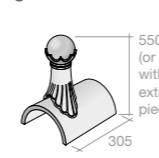
FINIALS

Mortar bedded security ridge kits are available (see page 125)

					
Description	Ball top finial* (half round base)	Ball top finial* (plain angle base)	Fleur-de-Lys gable* (half round base)	Fleur-de-Lys gable* (plain angle base)	Extension piece (for Ball top / Fleur-de-Lys)
Angles available	n/a	90°, 105°	n/a	90°, 105°	n/a
Colours available	Red Smooth	Red Smooth, Slate Black	Red Smooth	Red Smooth, Slate Black	Red Smooth, Slate Black
Pitch range	30-60°	See Tables 1, 3, 4, 5 & 6 (see page 179)	30-60°	See Tables 1, 3, 4, 5 & 6 (see page 179)	n/a

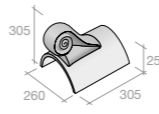
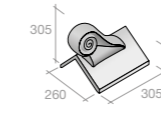
		
Description	Scroll finial* (half round base)	Scroll finial* (plain angle base)
Angles available	n/a	90°, 105°
Colours available	Red Smooth	Red Smooth, Slate Black
Pitch range	30-60°	See Tables 1, 3, 4, 5 & 6 (see page 179)

* Made to order (subject to minimum order quantities)

** Some colours and angles made to order (subject to minimum order quantities)

† Staffordshire Blue available to order

† Angle ridge wing length will vary depending on ridge angle

§ Available in Red Smooth

PROPERTIES & PERFORMANCE

CLAY PLAIN TILES

ANATOMY OF SINGLE CAMBER CLAY PLAIN TILE

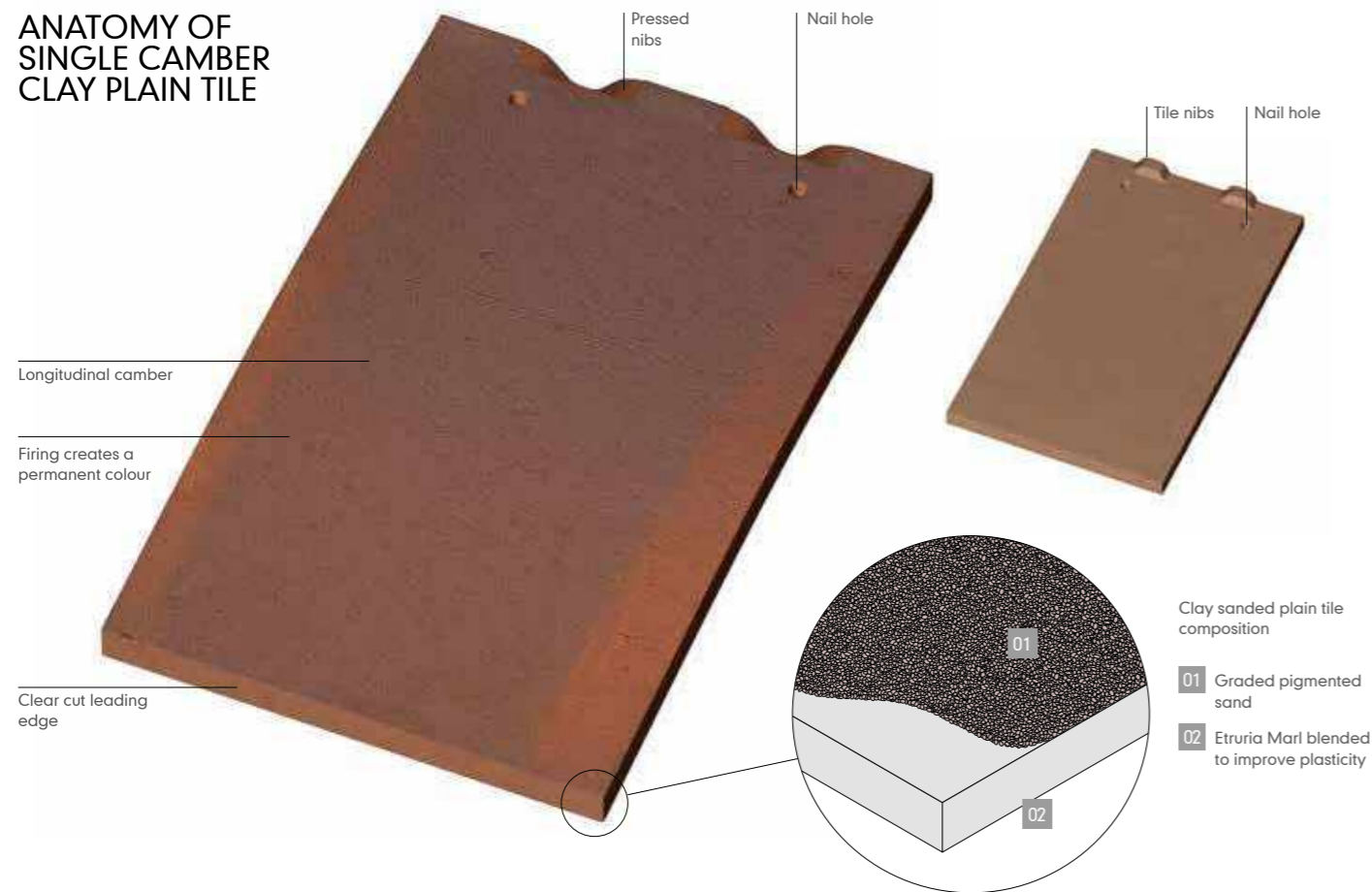

FEATURES OF CLAY PLAIN TILES

- ▲ Low pitch options down to 30°
- ▲ BES 6001 Certified 'Excellent'
- ▲ Can achieve A+ in the BRE Green Guide
- ▲ Suitable for roofing or vertical tiling
- ▲ 100% recyclable

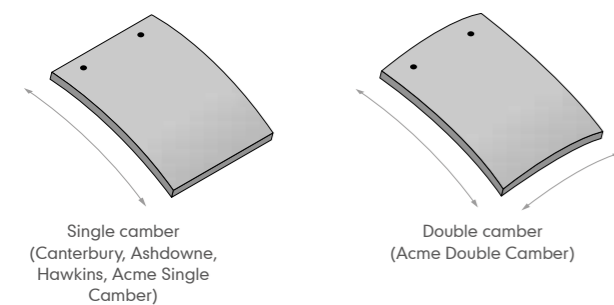

AUTHORITY

Marley clay roof tiles are manufactured to BS EN 1304 'Clay roofing tiles for discontinuous laying – Product definitions and specifications', operating a quality management system meeting the requirements of BS EN ISO 9001 'Quality Management Systems – requirements'.

Additionally, the manufacturing plant operates an environmental management system, in line with BS EN ISO 14001 'Environmental management systems – Specification with guidance for use' and Health and Safety Standard OHSAS 18001, working towards BS EN ISO 45001 certification.

Marley clay plain tiles are UKCA and CE marked in line with the Construction Product Regulation (marley.co.uk/sustainability). They are also rated 'Excellent' in the BES 6001 Framework Standard for the Responsible Sourcing of Construction Products.

CARBON FOOTPRINTING

Clay plain tiles can have a carbon footprint figure as low as 27 CO₂e/m².

RECYCLABILITY

At end of life, clay plain tiles can be reused or crushed and used as aggregate without the need for further processing. As a natural product, no special disposal considerations are required.

COMPOSITION AND MANUFACTURE

All Marley clay plain tiles are manufactured from high quality Staffordshire Etruria Marl, generally accepted as the finest clay for strength and durability.

Clays are carefully blended to improve plasticity and strength. The tiles are machine or hand moulded, dried and fired in gas fired tunnel kilns, using an advanced computer controlled system. This ensures that the products are made to exact tolerances in shape, size, colour and strength.

PERFORMANCE

Marley clay plain tiles are tested for resistance to wind driven rain and meet the requirements of BS 5534 'Code of practice for slating and tiling (including shingles)' with respect to wind loading, when fixed in accordance with our recommendations.

STRENGTH AND DURABILITY

Marley clay plain tiles are also extremely strong, with a transverse strength well in excess of the 600N minimum requirement in BS EN 1304.

FIRE RESISTANCE

Marley clay plain tiles are non-combustible and meet the requirements for external fire performance without the need for further testing in accordance with Class B roof of BS EN 13501-5 using data from external exposure to fire roof tests (BS 476-3) as defined in ENV 1187. There are no restrictions on their use under the Building Regulations and are designated AA in Table A5 of Appendix A, Approved Document B, 'Fire Safety'.

ENVIRONMENTAL EFFECTS

Thermal

Unaffected by extremes of temperature. Tiles should be laid with a slight gap (1-3mm) to accommodate any movement induced by changes in temperature.

The thermal resistance (R) of Marley clay tiles when dry is 0.013m²K/W.

For the purpose of thermal transmittance calculations, the preceding 'R' values should be substituted by a figure of 0.12m²K/W which includes the roof covering and the airspace behind the tiles or slates. An 'R' value of 0.020m²K/W should be added for the roof underlay.

Frost

Unaffected by frost, and meets the requirements of BS EN 1304 Annex A when tested to EN 539-2 in accordance with national requirements.

Sunlight

Clay tiles do not fade and are unaffected by prolonged exposure to UV and sunlight.

Atmospheric pollution

Suitable for all rural, marine and normal industrial environments. Avoid discharge of gases or liquids from chemical processes onto the surface of the tiles. Resistant to all but the most highly polluted atmospheres, where sulphur dioxide levels exceed 70 micrograms/m³ of air.

Electricity

Marley clay tiles are electronically insulating. Reference should be made to BS 6651 for recommendations on the protection of buildings against lightning strikes.

BIOLOGICAL EFFECTS

Birds and rodents

Not affected or degraded by birds, rodents or insects.

Mosses and lichens

Water absorption of Marley clay plain tiles is very low, making their surface less likely to support growth of mosses and lichens, unless promoted by local environmental factors such as overhanging trees. Removal may only be required if growth is sufficient to restrict the drainage of water from the roof.

HEALTH AND SAFETY

When cutting tiles using an angle grinder, measures to reduce the effect of dust should be taken in accordance with the HSE Guidance Note EH 40 'Occupational Exposure Limits', EH 44 'Dust in the workplace: general principles of protection' and HSE Guidance Note EH59/2 (Respiratory Crystalline Silica). For a copy of the Marley clay tiles Material Safety datasheet, visit marley.co.uk/sustainability

APPEARANCE

Clay is a natural product and as such, variation in colour and texture can occur. To avoid the risk of colour patching and bands of different shades, tiles should be randomly selected from at least three separate pallets from the same production batch. Ensure there are sufficient quantities of mixed tiles to complete each roof elevation.

FIXING SPECIFICATION

Tiles should be fixed in accordance with the recommendations of BS 5534. The Marley Technical Advisory Service can provide a fixing specification applicable for every roof design, given the relevant criteria relating to type of roof tile, site location, topography, and building/roof dimensions. Fixing specifications can also be completed online at marley.co.uk/specifying



Clay profiled tiles

Clay profiled tiles harness the beauty and warmth of natural clay and engineered high performance in one elegant package, giving specifier, installer and homeowner alike the best of all worlds.

Our extensive range contains colour and profile options which meet the aesthetic and performance demands of all types of roofing applications.

WHY CHOOSE CLAY PROFILED OR INTERLOCKING TILES?

- ▲ Easy to install
- ▲ Traditional profiles
- ▲ Low minimum pitch
- ▲ Precision engineered
- ▲ Quality and durability
- ▲ Beautiful natural clay

CLAY PROFILED TILES RANGE

- ▲ Eden (page 62)
- ▲ Lincoln (page 64)

EDEN

TRADITIONAL CLAY PANTILE

Eden is a non-interlocking, low pitch tile with deep, generous curves and a thin, refined leading edge.



TECHNICAL DATA

Size of tile	342mm x 247mm
Minimum pitch*	22.5° (72mm headlap)
Maximum pitch	75°
Minimum headlap	72mm
Maximum gauge	270mm
Tile thickness	13mm (nominal)
Covering capacity (net)	17.2 tiles/m ² at 72mm headlap
Weight of tiling (approx.)	40.42 kg/m ² (loading 0.40kN/m ²) at 72mm headlap
Battens required (net)	3.7 lin.m/m ² at 72mm headlap
Batten size recommended (fixed to BS 5534)	38 x 25mm for rafters/supports not exceeding 450mm centres 50 x 25mm for rafters/supports not exceeding 600mm centres
Tile nails	45mm x 3.35mm
Fixing clips	Eaves, verge and tile clips
Authority	BS EN 1304

* The minimum recommended pitch and lap may be influenced by special circumstances, please contact the Technical Advisory Service for further information.

EDEN FITTINGS

Available in Rustic Red and Natural Red.



CLAY INTERLOCKING FITTINGS

Available in Rustic Red and Natural Red.

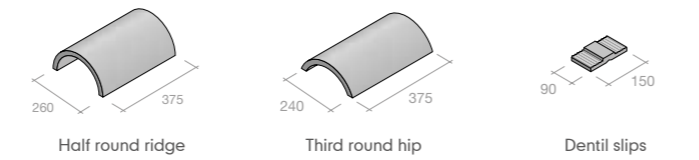

Note: All measurements in mm.



Rustic Red (smooth finish)



Natural Red (smooth finish)

LINCOLN
CLAY PANTILE



LINCOLN CLAY PANTILE

lowpitch



Lincoln combines the bold and beautiful curves of traditional clay pantiles with all the installation simplicity and speed required for today's roofs.

TECHNICAL DATA

Size of tile	370mm x 247mm
Minimum pitch*	15° *(100mm headlap) 22.5° (75mm headlap)
Maximum pitch	70°
Maximum gauge	294mm
Covering capacity (net)	15.3 tiles/m ² at 75mm headlap 16.65 tiles/m ² at 100mm headlap
Weight of tiling (approx.)	43.0kg/m ² (0.42 kN/m ²) at 75mm headlap 46.79kg and 0.46kn at 100mm headlap
Battens required (net)	3.4 lin.m/m ² at 75mm headlap 3.7 lin.m/m ² at 100mm headlap
Batten size recommended (fixed to BS 5534)	38 x 25mm for rafters/supports not exceeding 450mm centres 50 x 25mm for rafters/supports not exceeding 600mm centres
Tile nails	38mm x 3.35mm
Fixing clips	Eaves, verge and tile clips
Authority	BS EN 1304

* The tiles can be used in certain applications down to 12.5°, contact our Technical Advisory Service for technical guidance and support.

LINCOLN FITTINGS

Available in Rustic Red and Natural Red.

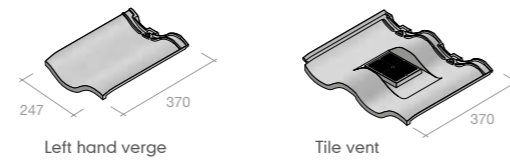

CLAY INTERLOCKING FITTINGS

Available in Rustic Red and Natural Red.

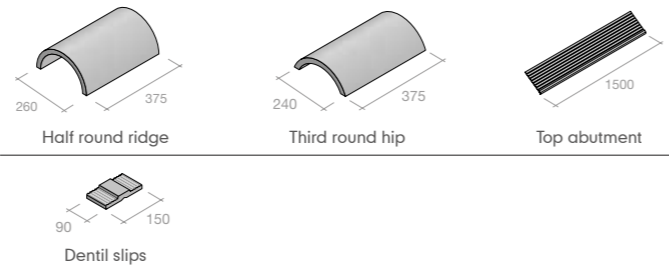

Note: All measurements in mm.



Location: Dovecote Barns Application: residential Product: Lincoln Rustic Red Specifier: Mark One Roofing



Rustic Red (smooth finish)



Natural Red (smooth finish)



Concrete tiles

From slate-like, riven textured products with a remarkably thin profile, to deeply profiled units, our broad ranges of single lap, interlocking tiles and plain tiles offer extensive design scope, as well as the performance long associated with concrete technology.

An unparalleled range of profile and colour offers the designer options for both residential and larger scale commercial roofing. Single lap interlocking tiles perform well on low or steeply pitched roofs, or large span buildings, with the dramatic visual appeal of profile and extensive colour range adding to the impact of the roofscape.

WHY CHOOSE CONCRETE?

- ▲ Engineered roofing solutions
- ▲ Proven performance
- ▲ Broad range of options
- ▲ Interlocking slates and profiled tiles
- ▲ Cost effective
- ▲ Unparalleled range of fittings and accessories
- ▲ A+ rated in the BRE Green Guide*
- ▲ BES 6001 'Excellent'

CONCRETE TILE RANGE

- ▲ Plain tile (page 70)
- ▲ Ashmore (page 72)
- ▲ Edgemere range (page 74)
- ▲ Modern and Duo Modern (page 78)
- ▲ Double Roman (page 82)
- ▲ Mendip (page 84)
- ▲ Ludlow Plus (page 86)
- ▲ Ludlow Major (page 88)
- ▲ EcoLogic Ludlow Major (page 90)
- ▲ Anglia (page 92)
- ▲ Wessex (page 94)

* Element refs: 812410017, 812410050, 812410064

PLAIN CONCRETE TILES

The authentic single camber design of the Marley concrete plain tile gives it a look to match its outstanding versatility.



TECHNICAL DATA

Size of tile	267mm x 168mm	
Minimum pitch*	35°	
Maximum pitch	90°	
Minimum headlap	Roof	65mm
	Vertical	37.5mm
Maximum gauge	Roof	100mm
	Vertical	115mm
Tile thickness	12mm (nominal)	
Cover width	168mm (nominal)	
Covering capacity (net)	Roof	60 tiles/m ² at 100mm gauge
	Vertical	53 tiles/m ² at 115mm gauge
Weight of tiling (approx.)	Roof	73.8kg/m ² (0.72 kN/m ²) at 100mm gauge
	Vertical	58kg/m ² (0.57 kN/m ²) at 115mm gauge
Battens required (net)	Roof	10.0 lin.m/m ² at 100mm gauge
	Vertical	8.7 lin.m/m ² at 115mm gauge
Batten size recommended (fixed to BS 5534)	38 x 25mm for rafters/supports not exceeding 600mm centres	
Tile nails	38mm x 2.65mm	
Authority	BS EN 490	

* The minimum recommended pitch and lap may be influenced by special circumstances, please contact the Technical Advisory Service for further information.

PLAIN TILE FITTINGS

Available in all colours.

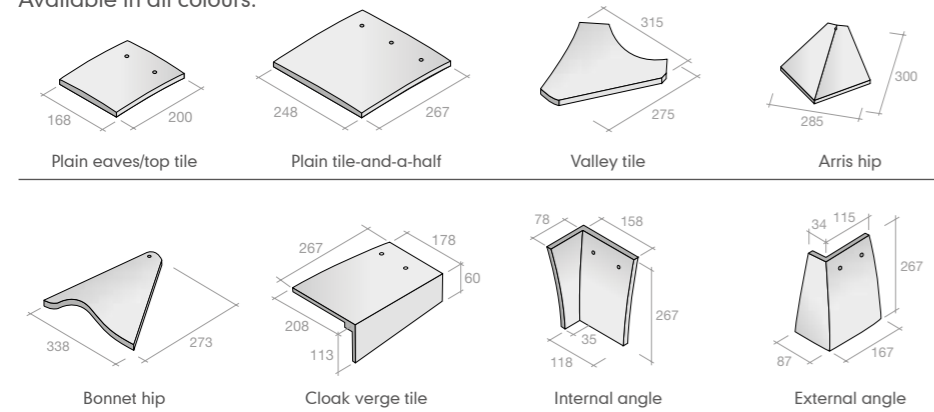

Note: All measurements in mm. For plain tile verges, ridges and hips, please see page 54

CLAY FEATURE TILES

Tile camber
Single camber

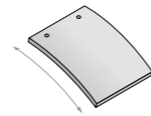

Feature tiles
Available in a range of colours.
For advice on the use of feature tiles in main roof areas, contact the Technical Advisory Service.

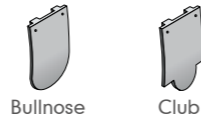

SUSTAINABILITY

Green guide rating** A+
BES 6001 Excellent

** Element Ref: 812410017, 812410050, 812410064



Location: Workington Application: Residential Product: Concrete plain tiles in Smooth Grey Specifier: Caine Consulting

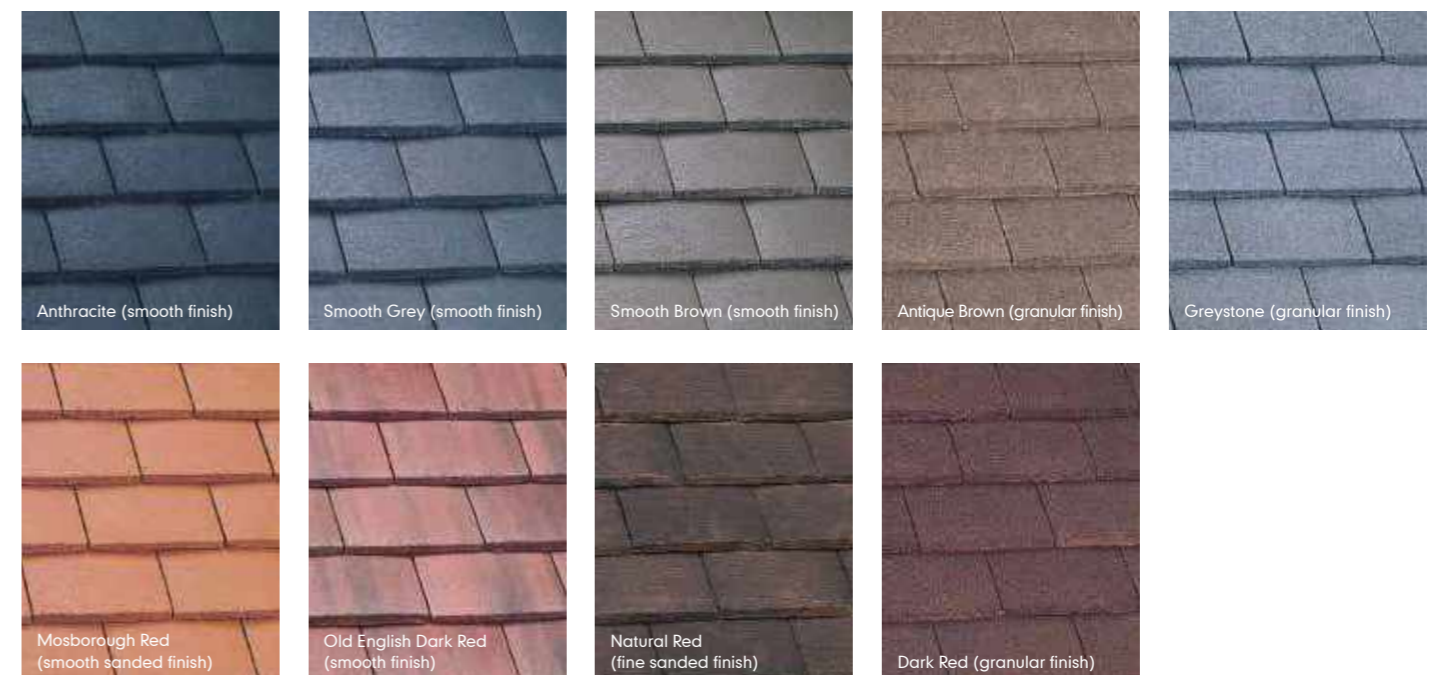

ASHMORE

INTERLOCKING CONCRETE PLAIN TILES

A single lap, interlocking double plain tile, with the engineered precision and ease of installation of an interlocking tile.



TECHNICAL DATA

Size of tile	267mm x 333mm
Minimum pitch*	25° (77mm headlap) 22.5° (92mm headlap)
Maximum pitch	90°
Minimum headlap	77mm
Maximum gauge	190mm
Cover width (nominal)	302mm
Tile thickness	16mm (nominal)
Cover width	302mm (nominal)
Hanging length	235mm
Covering capacity (net)	17.5 tiles/m ² at 77mm headlap 19 tiles/m ² at 92mm headlap
Weight of tiling (approx.)	48kg/m ² (0.47 kN/m ²) at 77mm headlap 52kg/m ² (0.51 kN/m ²) at 92mm headlap
Battens required (net)	5.3 lin.m/m ² at 77mm gauge 5.8 lin.m/m ² at 92mm gauge
Batten size recommended (fixed to BS 5534)	38 x 25mm for rafters/supports not exceeding 450mm centres 50 x 25mm for rafters/supports not exceeding 600mm centres
Tile nails	45mm x 3.35mm
Fixing clips	Eaves, verge and tile clips
Authority	BS EN 490

* The minimum recommended pitch and lap may be influenced by special circumstances, please contact the Technical Advisory Service for further information.

SUSTAINABILITY

Green guide rating**	A+
BES 6001	Excellent

** Element Refs: 812410007, 812410018, 812410049

ASHMORE TILE FITTINGS

Available in all colours.

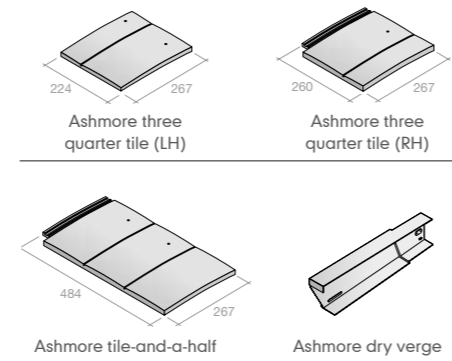

Ashmore tiles should be laid broken-bond. The required broken-bond pattern is created by the introduction of three quarter width tiles in alternate courses. Tile-and-a-half tiles are available for use at hips and valleys.



Old English Dark Red (smooth finish)



Smooth Brown (smooth finish)



Smooth Grey (smooth finish)

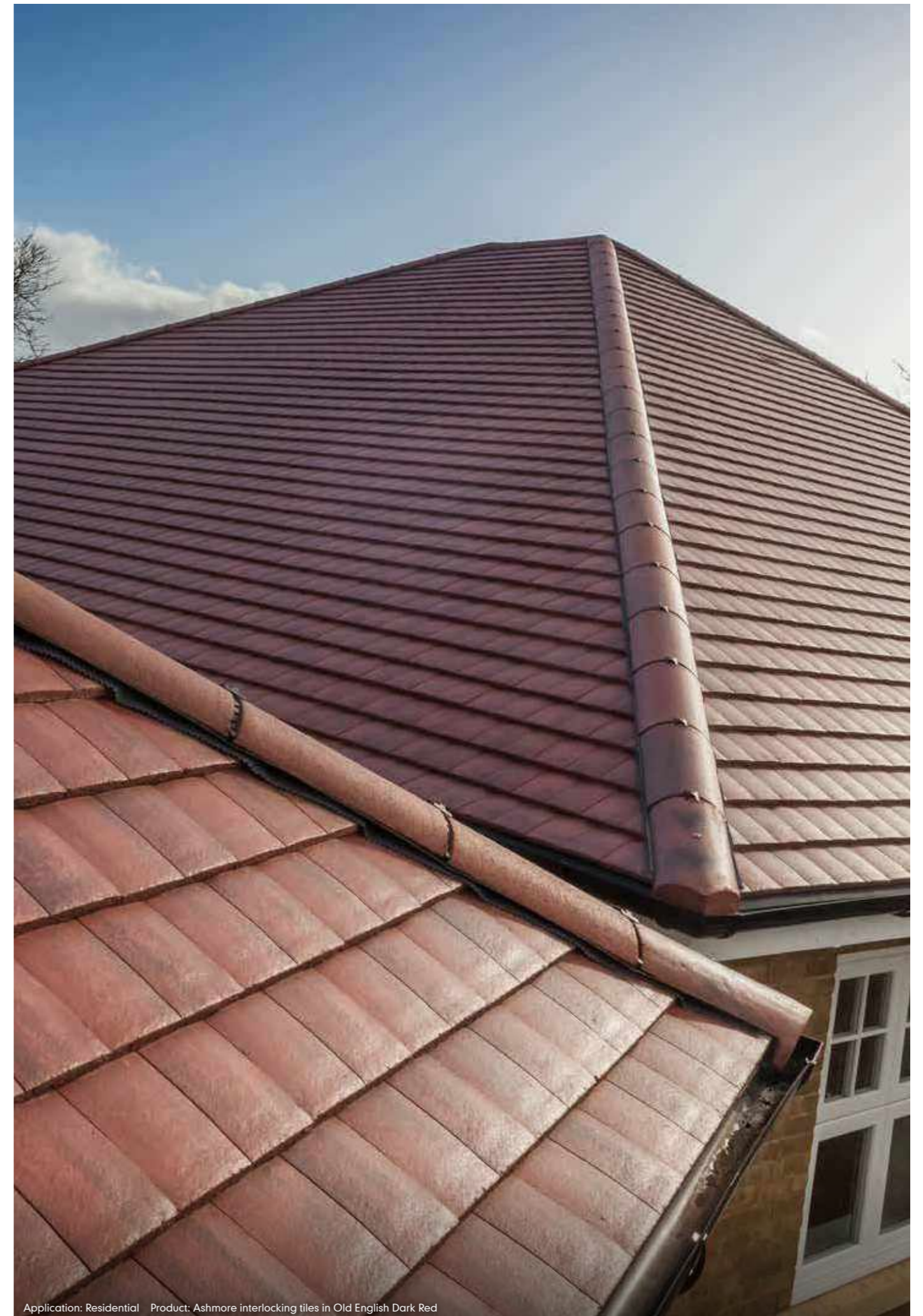

Application: Residential Product: Ashmore interlocking tiles in Old English Dark Red

EDGEMERE
CONCRETE INTERLOCKING SLATE RANGE



Location: Scotland Application: Residential Product: Edgemere interlocking slate in Smooth Grey and Edgemere dry verge Specifier: AJC Homes

EDGEMERE

CONCRETE INTERLOCKING SLATE RANGE

The thin (18mm) leading edge of Standard, Duo and Riven Edgemere slates, offers a range of low profile and slate-like solutions, providing an affordable upgrade to standard interlocking tiles, or a cost-effective alternative to natural slate.

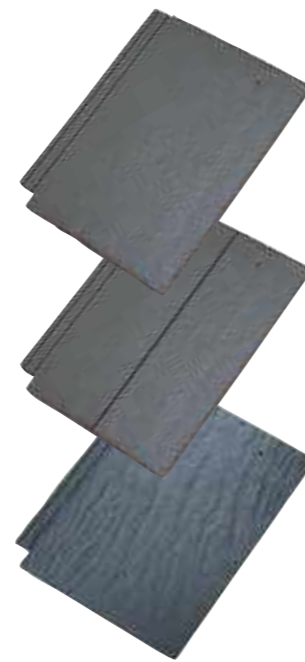

TECHNICAL DATA

Size of tile	420mm x 330mm
Minimum pitch*	22.5° (75mm lap) 17.5° (100mm lap)
Maximum pitch	90°
Minimum lap	75mm (22.5° and above) 100mm (below 22.5°)
Maximum gauge	345mm
Cover width (nominal)	298mm
Tile thickness (nominal)	18mm
Hanging length (nominal)	395mm
Covering capacity (net)	9.7 slates/m ² at 75mm lap 10.5 slates/m ² at 100mm lap
Weight of slating (approx.)	44 kg/m ² (0.43 kN/m ²) at 75mm lap 47.5 kg/m ² (0.47 kN/m ²) at 100mm lap
Battens required (net)	2.9 lin.m/m ² at 75mm lap 3.1 lin.m/m ² at 100mm lap
Batten size recommended (fixed to BS 5534)	38 x 25mm for rafters/supports not exceeding 450mm centres 50 x 25mm for rafters/supports not exceeding 600mm centres
Tile nails	Slate nails 45mm x 3.35mm
Fixing clips	Eaves, verge and tile clips, SoloFix
Authority	BS EN 490

* The minimum recommended pitch and lap may be influenced by special circumstances, please contact the Technical Advisory Service for further information.

Edgemere[†] has a clean and precise slate-like appearance, enhanced by the thin leading edge and the broken-bond laying technique.

Duo Edgemere[‡] concrete interlocking slates are designed to look like and blend in with small format slates.

Riven Edgemere[†] has a randomised texture applied to the surface to ensure an attractive and variegated appearance, and a finish which even more closely resembles natural slate.

SUSTAINABILITY

Green guide rating**	A+
BES 6001	Excellent

** Element Refs: 812410007, 812410018, 812410049

EDGEMERE TILE FITTINGS

Available in all colours.

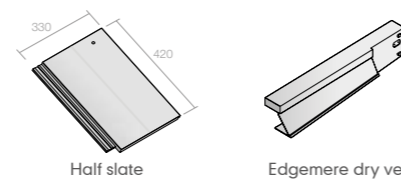

Note: All measurements in mm.

† Edgemere and Riven Edgemere should be laid broken-bond. The required broken-bond pattern is created by the introduction of half slates to form verges in alternate courses.

‡ Duo Edgemere should be laid a quarter broken-bond. The required broken-bond pattern is created by the introduction of three quarter width slates, cut from standard slates on site to form verge slates in alternate courses.



Edgemere Old English Dark Red (smooth finish)



Edgemere Smooth Grey (smooth finish)



Edgemere Anthracite (smooth finish)

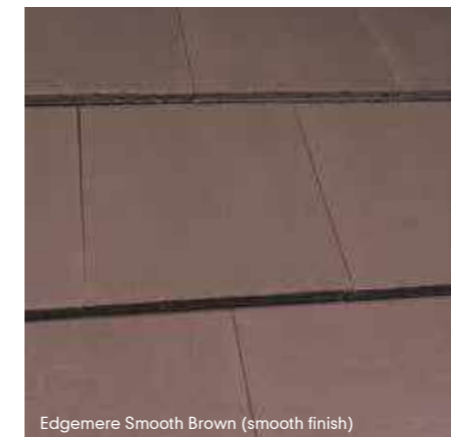

Edgemere Smooth Brown (smooth finish)



Riven Edgemere Smooth Grey (smooth finish)



Riven Edgemere Anthracite (smooth finish)



Duo Edgemere Old English Dark Red (smooth finish)



Duo Edgemere Smooth Grey (smooth finish)

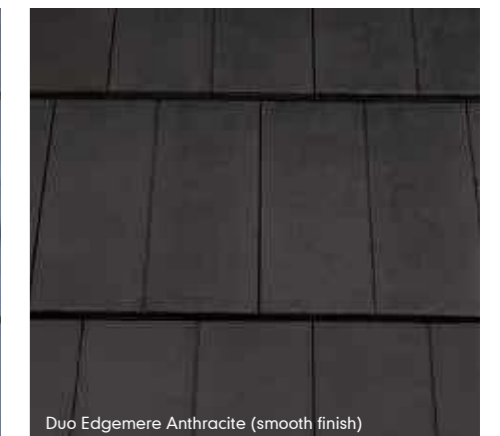

Duo Edgemere Anthracite (smooth finish)

MODERN
CONCRETE INTERLOCKING TILE RANGE



Location: Milford Haven Application: Residential Product: Modern full system specification using interlocking tiles in Smooth Grey and Old English Dark Red Specifier: L Greggain & Co.

MODERN

CONCRETE INTERLOCKING TILE RANGE

A flat, smooth, single-lap interlocking design whose slate-like appearance is enhanced by the required broken-bond laying pattern.



Location: Bridgend, Wales Application: Residential Product: Modern interlocking tile in Smooth Grey

TECHNICAL DATA

Size of tile	420mm x 330mm	
Minimum pitch*	Smooth	Granular
	22.5° (75mm lap) 17.5° (100mm lap)	30° (75mm lap) 25° (100mm lap)
Maximum pitch	90°	
Minimum lap	75mm (22.5° and above) 100mm (below 22.5°)	
Maximum gauge	345mm	
Cover width (nominal)	292mm	
Tile thickness (nominal)	30mm	
Hanging length (nominal)	397mm	
Covering capacity (net)	9.9 tiles/m ² at 75mm lap	
	10.7 tiles/m ² at 100mm lap	
Weight of slating (approx.)	50 kg/m ² (0.49 kN/m ²) at 75mm lap	
	54 kg/m ² (0.53 kN/m ²) at 100mm lap	
Battens required (net)	2.9 lin.m/m ² at 75mm lap	
	3.1 lin.m/m ² at 100mm lap	
Batten size recommended (fixed to BS 5534)	38 x 25mm for rafters/supports not exceeding 450mm centres	
	50 x 25mm for rafters/supports not exceeding 600mm centres	
Tile nails	Tile nails 50mm x 3.35mm	
Fixing clips	Eaves, verge and tile clips, SoloFix	
Authority	BS EN 490	

* The minimum recommended pitch and lap may be influenced by special circumstances, please contact the Technical Advisory Service for further information.

Enhanced with a broken-bond, Modern[†] provides a slate-like appearance, offering a very practical and affordable slate-like roof with excellent performance properties.

Duo Modern[‡] incorporates a mock bond down the centre of the tile, giving the appearance of a small format slate.

SUSTAINABILITY

Green guide rating**	A+
BES 6001	Excellent

** Element Refs: 812410007, 812410018, 812410049

MODERN TILE FITTINGS

Available in all colours.

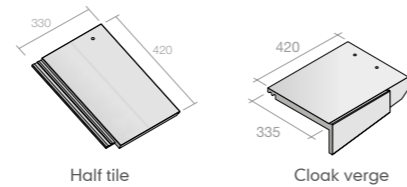

Note: All measurements in mm.

† Modern should be laid broken-bond. The required broken-bond pattern is created by the introduction of half tiles, to form verges in alternate courses.

‡ Duo Modern should be laid a quarter broken-bond. The required broken-bond pattern is created by the introduction of three quarter width tiles, cut from standard slates on site to form verge slates in alternate courses.



Modern Old English Dark Red (smooth finish)



Modern Smooth Brown (smooth finish)



Modern Antique Brown (granular finish)



Modern Anthracite (smooth finish)



Modern Smooth Grey (smooth finish)



Modern Mosborough Red (smooth finish)



Duo Modern Smooth Grey (smooth finish)



Duo Modern Old English Dark Red (smooth finish)

DOUBLE ROMAN CONCRETE INTERLOCKING TILES

A 2000 year old profile with precision-engineered functionality.



TECHNICAL DATA

Size of tile	420mm x 330mm
Minimum pitch*	25° Smooth (75mm headlap) 30° Granular (75mm headlap) 22.5° Smooth (100mm headlap)
Maximum pitch	90°
Minimum headlap	75mm (pitch and surface dependent)
Maximum gauge	345mm
Cover width (nominal)	300mm
Body thickness (nominal)	28mm
Overall depth	53mm
Hanging length (nominal)	397mm
Covering capacity (net)	9.7 tiles/m ² at 75mm headlap 10.4 tiles/m ² at 100mm headlap
Weight of tiling (approx.)	44 kg/m ² (0.43 kN/m ²) at 75mm headlap 47 kg/m ² (0.46 kN/m ²) at 100mm headlap
Battens required (net)	2.9 lin.m/m ² at 75mm headlap 3.1 lin.m/m ² at 100mm headlap
Batten size recommended (fixed to BS 5534)	38 x 25mm for rafters/supports not exceeding 450mm centres 50 x 25mm for rafters/supports not exceeding 600mm centres
Tile nails	65mm x 3.35mm
Fixing clips	Eaves, verge and tile clips
Authority	BS EN 490

* The minimum recommended pitch and lap may be influenced by special circumstances, please contact the Technical Advisory Service for further information.

SUSTAINABILITY

Green guide rating**	A+
BES 6001	Excellent

** Element Refs: 812410017, 81240050, 81240064

DOUBLE ROMAN FITTINGS

Available in all colours.

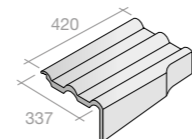

Cloak verge

Cloak verge half tile also available
Note: All measurements in mm.



Location: Old Sarum Application: Residential Product: Double Roman interlocking tiles in Old English Dark Red



Smooth Grey (smooth finish)



Antique Brown (granular finish)



Smooth Brown (smooth finish)



Greystone (granular finish)



Mosborough Red (smooth finish)



Old English Dark Red (smooth finish)



Dark Red (granular finish)

MENDIP & MENDIP 12.5 CONCRETE INTERLOCKING TILES

A double pantile design with elegant flowing lines, instant visual appeal and exceptional strength.



MENDIP TECHNICAL DATA

Size of tile	420mm x 330mm
Minimum pitch*	17.5° Smooth (75mm headlap) 15° Smooth (100mm headlap) 30° Granular (75mm headlap) 25° Smooth (100mm headlap)
Maximum pitch	90°
Minimum headlap	75mm (pitch and surface dependent)
Maximum gauge	345mm
Cover width (nominal)	298mm
Body thickness (nominal)	27mm
Overall depth	59mm
Hanging length (nominal)	397mm
Covering capacity (net)	9.7 tiles/m ² at 75mm headlap 10.5 tiles/m ² at 100mm headlap
Weight of tiling (approx.)	46 kg/m ² (0.45 kN/m ²) at 75mm headlap 49 kg/m ² (0.48 kN/m ²) at 100mm headlap
Battens required (net)	2.9 lin.m/m ² at 75mm headlap 3.1 lin.m/m ² at 100mm headlap
Batten size recommended (fixed to BS 5534)	38 x 25mm for rafters/supports not exceeding 450mm centres 50 x 25mm for rafters/supports not exceeding 600mm centres
Tile nails	70mm x 3.35mm
Fixing clips	Eaves, verge and tile clips
Authority	BS EN 490

* The minimum recommended pitch and lap may be influenced by special circumstances, please contact the Technical Advisory Service for further information.

SUSTAINABILITY

Green guide rating**	A+
BES 6001	Excellent

** Element Refs: 812410007, 812410018, 812410049

EXTENDED RAFTER LENGTHS

Mendip interlocking tiles can now perform at extended rafter lengths as follows:

- 12.5° - 17.5° pitch with a rafter length up to and including 15m will require a 100mm headlap.
- 17.5° pitch and above with a rafter length up to and including 15m will require a 75mm headlap.

MENDIP TILE FITTINGS

Available in all colours.

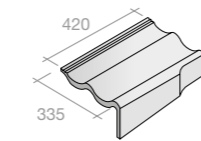

Cloak verge (Mendip only)

Cloak verge half tile also available

Note: All measurements in mm.



Application: Veterinary Product: Mendip interlocking tiles in Old English Dark Red



MENDIP 12.5 TECHNICAL DATA

Size of tile	420mm x 330mm
Minimum pitch*	12.5° Smooth (100mm headlap)
Maximum pitch	60°
Minimum headlap	100mm (pitch and surface dependent)
Maximum gauge	320mm
Cover width (nominal)	298mm
Body thickness (nominal)	27mm
Overall depth	59mm
Hanging length (nominal)	397mm
Covering capacity (net)	10.5 tiles/m ² at 100mm headlap
Weight of tiling (approx.)	49 kg/m ² (0.48 kN/m ²) at 100mm headlap
Battens required (net)	3.1 lin.m/m ² at 100mm headlap
Batten size recommended (fixed to BS 5534)	38 x 25mm for rafters/supports not exceeding 450mm centres 50 x 25mm for rafters/supports not exceeding 600mm centres
Tile nails	70mm x 3.35mm
Fixing clips	Eaves, verge and tile clips
Authority	BS EN 490

* The minimum recommended pitch and lap may be influenced by special circumstances, please contact the Technical Advisory Service for further information.

SUSTAINABILITY

Green guide rating**	A+
BES 6001	Excellent

** Element Refs: 812410007, 812410018, 812410049



LUDLOW PLUS

CONCRETE INTERLOCKING TILES



Ideal for refurbishment applications, where its smaller format reduces wastage.

TECHNICAL DATA

Size of tile	387mm x 230mm
Minimum pitch*	25° Smooth (75mm headlap) 30° Granular (75mm headlap) 22.5° Smooth (100mm headlap)
Maximum pitch	90°
Minimum headlap	75mm (pitch and surface dependent)
Maximum gauge	312mm
Cover width (nominal)	204mm
Body thickness (nominal)	25mm
Hanging length (nominal)	361mm
Covering capacity (net)	15.7 tiles/m ² at 75mm headlap 17.1 tiles/m ² at 100mm headlap
Weight of tiling (approx.)	47 kg/m ² (0.46 kN/m ²) at 75mm headlap 51 kg/m ² (0.50 kN/m ²) at 100mm headlap
Battens required (net)	3.2 lin.m/m ² at 75mm headlap 3.5 lin.m/m ² at 100mm headlap
Batten size recommended (fixed to BS 5534)	38 x 25mm for rafters/supports not exceeding 450mm centres 50 x 25mm for rafters/supports not exceeding 600mm centres
Tile nails	50mm x 3.35mm
Fixing clips	Eaves, verge and tile clips
Authority	BS EN 490

* The minimum recommended pitch and lap may be influenced by special circumstances, please contact the Technical Advisory Service for further information.

SUSTAINABILITY

Green guide rating**	A+
BES 6001	Excellent

** Element Refs: 812410007, 812410018, 812410049

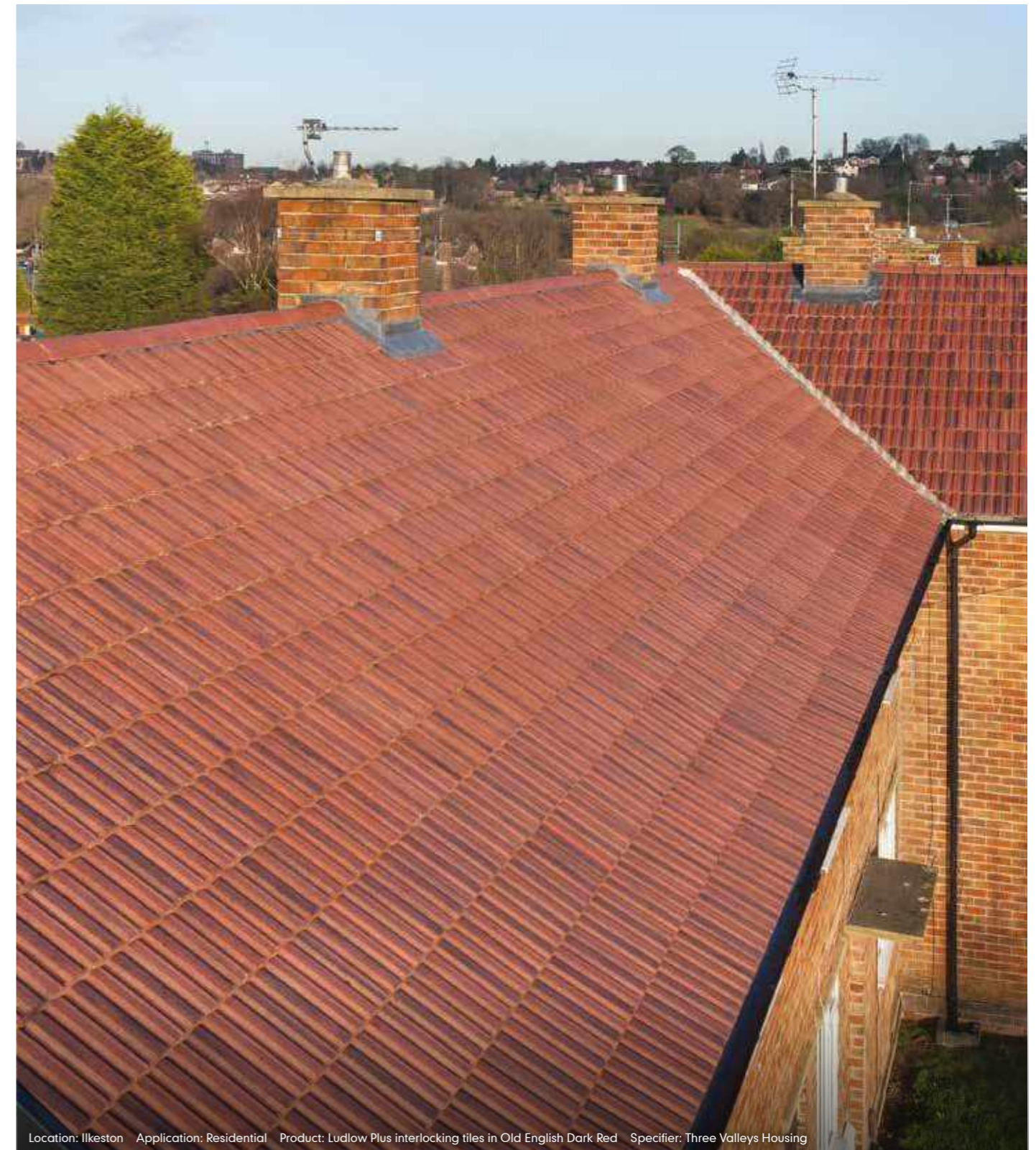

Location: Ilkeston Application: Residential Product: Ludlow Plus interlocking tiles in Old English Dark Red Specifier: Three Valleys Housing



Smooth Grey (smooth finish)



Greystone (granular finish)



Old English Dark Red (smooth finish)



Dark Red (granular finish)



Smooth Brown (smooth finish)



Antique Brown (granular finish)

LUDLOW MAJOR

CONCRETE INTERLOCKING TILES

Simple, strong lines exploit the interplay between light and shade.



TECHNICAL DATA

Size of tile	420mm x 330mm
Minimum pitch*	25° Smooth (75mm headlap) 30° Granular (75mm headlap) 22.5° Smooth (100mm headlap)
Maximum pitch	90°
Minimum headlap	75mm (pitch and surface dependent)
Maximum gauge	345mm
Cover width (nominal)	295mm
Body thickness (nominal)	25mm
Hanging length (nominal)	399mm
Covering capacity (net)	9.8 tiles/m ² at 75mm headlap 10.6 tiles/m ² at 100mm headlap
Weight of tiling (approx.)	45 kg/m ² (0.44 kN/m ²) at 75mm headlap 49 kg/m ² (0.48 kN/m ²) at 100mm headlap
Battens required (net)	2.9 lin.m/m ² at 75mm headlap 3.1 lin.m/m ² at 100mm headlap
Batten size recommended (fixed to BS 5534)	38 x 25mm for rafters/supports not exceeding 450mm centres 50 x 25mm for rafters/supports not exceeding 600mm centres
Tile nails	55mm x 3.35mm
Fixing clips	Eaves, verge and tile clips
Authority	BS EN 490

* The minimum recommended pitch and lap may be influenced by special circumstances, please contact the Technical Advisory Service for further information.

SUSTAINABILITY

Green guide rating**	A+
BES 6001	Excellent

** Element Refs: 812410007, 812410018, 812410049



Location: Bridgend Application: Residential Product: Ludlow Major interlocking tiles in Antique Brown Specifier: Valleys to Coast Housing



Smooth Grey (smooth finish)



Antique Brown (granular finish)



Smooth Brown (smooth finish)



Greystone (granular finish)

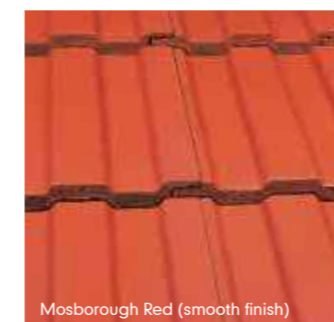

Mosborough Red (smooth finish)



Old English Dark Red (smooth finish)

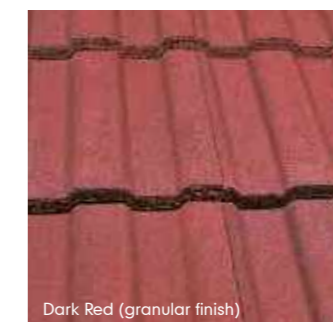

Dark Red (granular finish)

As more emphasis is being placed on the sustainability of building materials, either one of these characteristics would present a good case for specification, particularly where the optimisation of the inhabitants' environmental conditions is paramount. EcoLogic tiles incorporate environmental properties, sustainability and the cost effective performance characteristics of concrete tile technology into one product, making them an unbeatable choice for today's urban projects.



ECOLOGIC LUDLOW MAJOR CONCRETE INTERLOCKING TILES



The unique EcoLogic™ coating removes nitrogen oxides and other pollutants from the atmosphere.

TECHNICAL DATA

Size of tile	420mm x 330mm
Minimum pitch*	30° Granular (75mm headlap)
Maximum pitch	90°
Minimum headlap	75mm
Maximum gauge	345mm
Cover width (nominal)	295mm
Body thickness (nominal)	25mm
Hanging length (nominal)	399mm
Covering capacity (net)	9.8 tiles/m ² at 75mm headlap 10.6 tiles/m ² at 100mm headlap
Weight of tiling (approx.)	45 kg/m ² (0.44 kN/m ²) at 75mm headlap 49 kg/m ² (0.48 kN/m ²) at 100mm headlap
Battens required (net)	2.9 lin.m/m ² at 75mm headlap 3.1 lin.m/m ² at 100mm headlap
Batten size recommended (fixed to BS 5534)	38 x 25mm for rafters/supports not exceeding 450mm centres 50 x 25mm for rafters/supports not exceeding 600mm centres
Tile nails	55mm x 3.35mm
Fixing clips	Eaves, verge and tile clips
Authority	BS EN 490

* The minimum recommended pitch and lap may be influenced by special circumstances, please contact the Technical Advisory Service for further information.

SUSTAINABILITY

Green guide rating**	A+
BES 6001	Excellent
Level of recycled content	High

** Element Refs: 812410007, 812410018, 812410049



Nimbus Grey (granular finish)

ANGLIA

CONCRETE INTERLOCKING TILES

Anglia is a single-lap interlocking tile with the appearance of a classic clay pantile, enhanced with a bullnose leading edge.

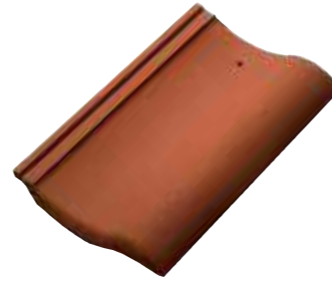

TECHNICAL DATA

Size of tile	387mm x 229mm
Minimum pitch*	30° Smooth (75mm headlap) 30° Granular (75mm headlap) 25° Smooth (100mm headlap)
Maximum pitch	90°
Minimum headlap	75mm (pitch and surface dependent)
Maximum gauge	312mm
Cover width (nominal)	204mm
Body thickness (nominal)	30mm
Overall depth	71mm
Hanging length (nominal)	370mm
Covering capacity (net)	15.7 tiles/m ² at 75mm headlap 17.1 tiles/m ² at 100mm headlap
Weight of tiling (approx.)	47 kg/m ² (0.46 kN/m ²) at 75mm headlap 51 kg/m ² (0.50 kN/m ²) at 100mm headlap
Battens required (net)	3.2 lin.m/m ² at 75mm headlap 3.5 lin.m/m ² at 100mm headlap
Batten size recommended (fixed to BS 5534)	38 x 25mm for rafters/supports not exceeding 450mm centres 50 x 25mm for rafters/supports not exceeding 600mm centres
Tile nails	38mm x 3.35mm
Fixing clips	Eaves, verge and tile clips
Authority	BS EN 490

* The minimum recommended pitch and lap may be influenced by special circumstances, please contact the Technical Advisory Service for further information.

SUSTAINABILITY

Green guide rating**	A+
BES 6001	Excellent

** Element Refs: 812410007, 812410018, 812410049

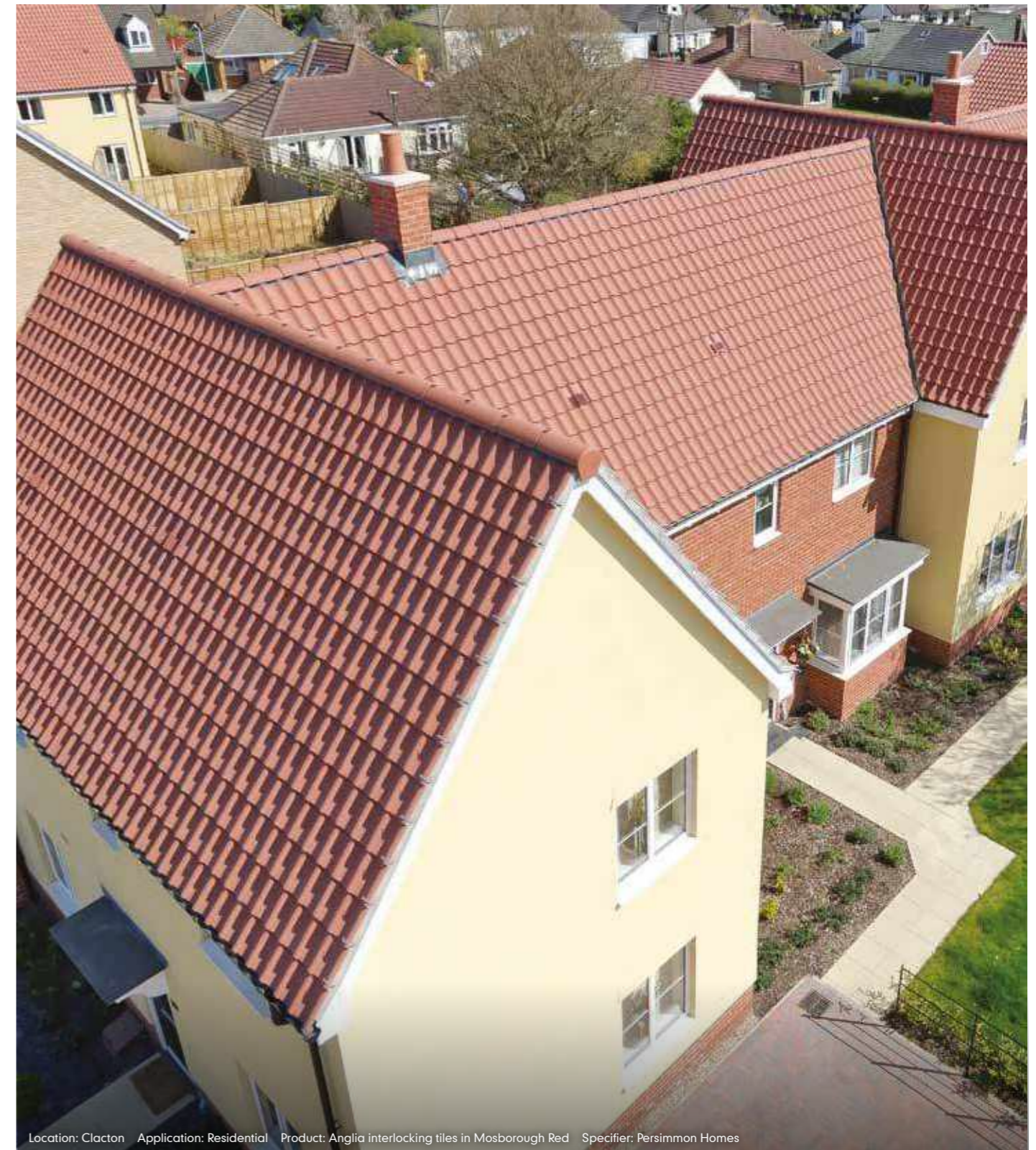

Location: Clacton Application: Residential Product: Anglia interlocking tiles in Mosborough Red Specifier: Persimmon Homes



Anthracite (smooth finish)



Smooth Grey (smooth finish)



Antique Brown (granular finish)



Mosborough Red (smooth finish)



Old English Dark Red (smooth finish)

WESSEX

CONCRETE INTERLOCKING TILES

Designed to shed water efficiently at pitches down to 15°, Wessex has clean, simple lines with a pleasing minimalist style.

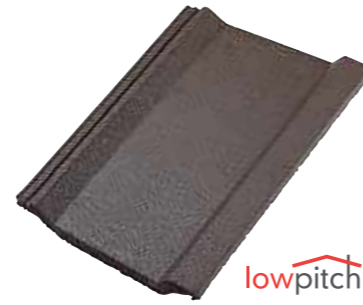

TECHNICAL DATA

Size of tile	420mm x 330mm
Minimum pitch*	15°
Maximum pitch	44°
Minimum headlap	75mm
Maximum gauge	345mm
Cover width (nominal)	298mm
Body thickness (nominal)	29mm
Hanging length (nominal)	403mm
Overall depth	56mm
Covering capacity (net)	9.7 tiles/m ² at 75mm headlap 10.5 tiles/m ² at 100mm headlap
Weight of tiling (approx.)	50 kg/m ² (0.49 kN/m ²) at 75mm headlap 53 kg/m ² (0.52 kN/m ²) at 100mm headlap
Battens required (net)	2.9 lin.m/m ² at 75mm headlap 3.1 lin.m/m ² at 100mm headlap
Batten size recommended (fixed to BS 5534)	38 x 25mm for rafters/supports not exceeding 450mm centres 50 x 25mm for rafters/supports not exceeding 600mm centres
Fixing clips	Eaves, verge and tile clips
Authority	BS EN 490

* The minimum recommended pitch and lap may be influenced by special circumstances, please contact the Technical Advisory Service for further information.

SUSTAINABILITY

Green guide rating**	A+
BES 6001	Excellent

** Element Refs: 812410017, 81240050, 81240064



Location: Bournemouth Application: Education Product: Wessex interlocking tiles in Smooth Grey Specifier: Trinity Architects



Smooth Grey (smooth finish)



Smooth Brown (smooth finish)

HAYFIELD GRANGE CASE STUDY



PROJECT INFORMATION

Location
Aberdeen

Application
Residential

Product
Duo Edgemere interlocking
slates in Smooth Grey

Specifier
Marley Contract Services

Marley's Duo Edgemere slates have been used to give a slate-like finish on an award winning roofing project for ten prestigious new build homes in the highly desirable Cults area of Aberdeen.

The Cala Homes development at Hayfield Grange includes ten detached luxury properties finished with a distinctive exterior. Marley Contract Services was appointed to complete the roofing contract and specified the Duo Edgemere tiles in Smooth Grey to complement the stone finish of the homes. Marley's concrete plain tiles were also used around the dormer windows on the luxury homes.

▲ Find more case studies at marley.co.uk/case-studies

FITTINGS & ACCESSORIES CONCRETE TILES & SLATES

Marley manufacture a wide range of concrete plain tile fittings, decorative ridges and finials. All products can be installed in line with the latest BS 5534 'Code of Practice for Slating and Tiling' and NHBC Technical Standards.

RIDGES AND HIP TILES

Mortar bedded security ridge kits are available (see page 125).

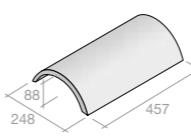
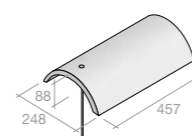
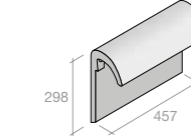
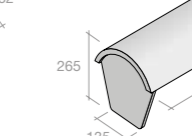
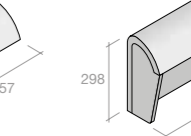
					
Description	Segmental ridge†‡§	Segmental security ridge	Segmental mono-ridge†§	Segmental block end ridge†§	Segmental mono block end ridge†§
Colours available	All colours	All colours	All colours	All colours	All colours
Pitch range	15-60° dry ridge	15-50° bedded	15-55° dry ridge	15-60° dry ridge	15-55° dry ridge

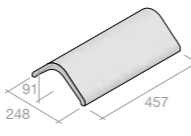
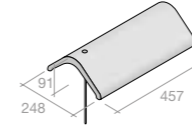
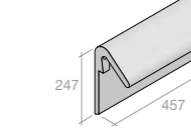
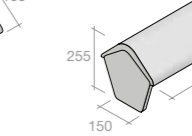
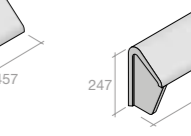
					
Description	Modern ridge†‡§•	Modern security ridge	Modern mono-ridge	Modern block end ridge†	Modern mono block end ridge†§
Colours available	All colours	All colours	All colours	All colours	All colours
Pitch range	15-55° dry ridge	15-45° bedded	15-45° bedded	15-55° dry ridge	15-45°

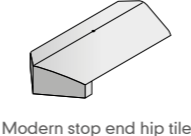
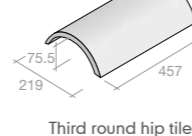
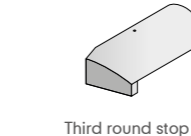
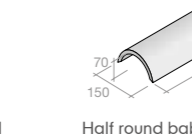
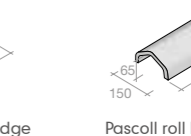
					
Description	Modern stop end hip tile	Third round hip tile	Third round stop end	Half round baby ridge	Pascoll roll baby ridge
Colours available	All colours	All colours	All colours	All colours	All colours
Pitch range	15-55°†‡§	17.5-45°†‡§	15-55°†‡§	15-55°	15-45°

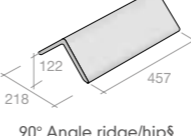
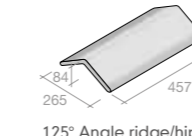
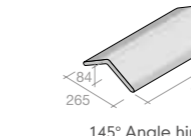
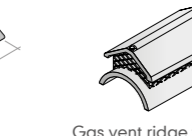
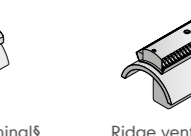
					
Description	90° Angle ridge/hip§ 90° security angle ridge/hip†‡	125° Angle ridge/hip Security 125° Angle ridge/hip	145° Angle hip Security 145° Angle ridge/hip	Gas vent ridge terminal§	Ridge vent terminal§
Colours available	see below*	see below*	see below*	see below**	see below**
Pitch range	45-50° bedded	12-25°	15-25°	15-55° dry ridge	15-55° dry ridge

† Compatible with Marley ventilated dry ridge system

‡ Compatible with Marley dry hip system

§ Compatible with Marley Universal RidgeFast

¶ Compatible with Marley Universal HipFast

* Available in Smooth Grey, Mosborough Red, Smooth Brown and Old English Dark Red

** Available in Smooth Grey, Mosborough Red, Smooth Brown and Anthracite

◇ 60° Plain, Mendip, Wessex and Anglia only

PROPERTIES & PERFORMANCE

CONCRETE TILES & SLATES

ANATOMY OF MENDIP CONCRETE INTERLOCKING TILE

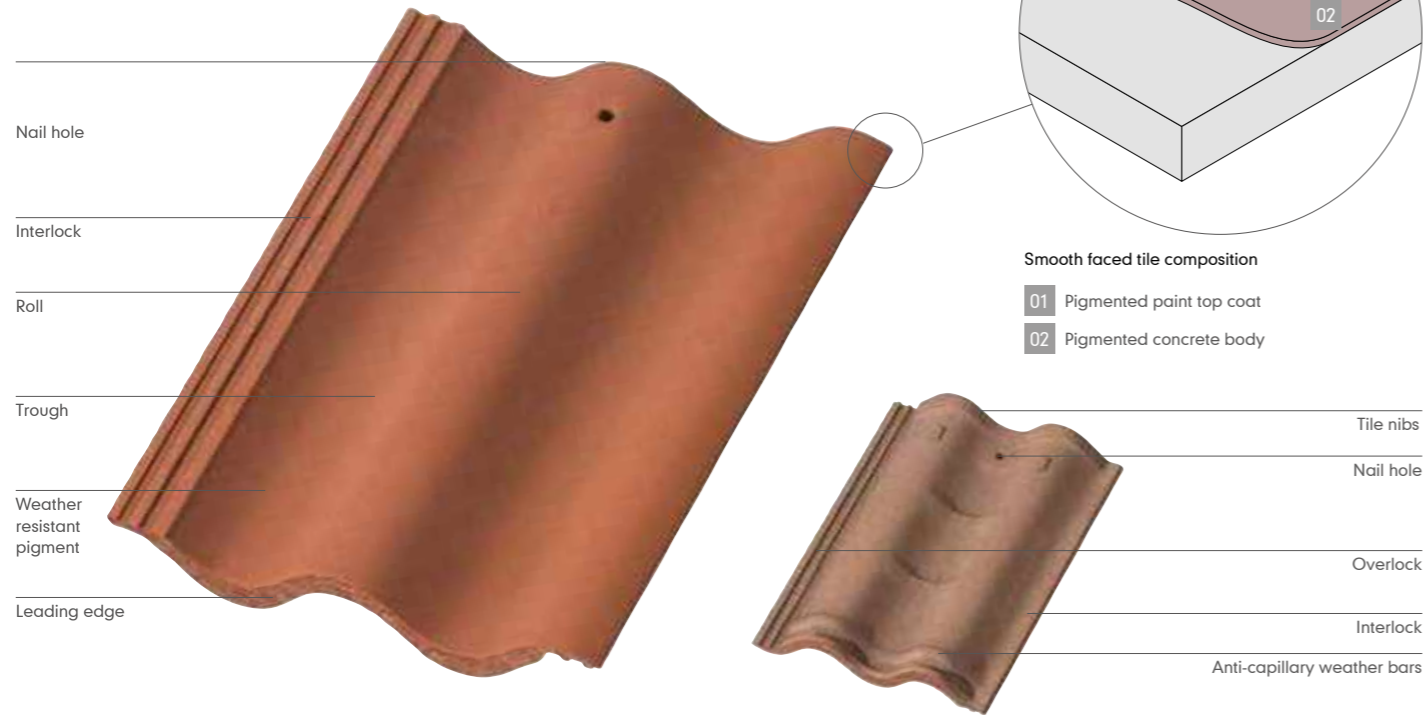

FEATURES OF CONCRETE TILES AND SLATES

- ▲ Low pitch options down to 12.5°
- ▲ Can achieve an A+ rating in the BRE Green Guide
- ▲ BES 6001 certified 'Excellent'
- ▲ Proven in application to last many years
- ▲ Clean, low energy production process
- ▲ Fully recyclable

AUTHORITY

Marley concrete roof tiles and slates are UKCA and CE marked as being manufactured to the requirements of BS EN 490 'Concrete roofing tiles and fittings – Product specifications', operating a quality management system meeting the requirements of ISO 9001 'Quality management systems – requirements'.



SUSTAINABILITY

Marley concrete tiles are UKCA and CE marked in line with the Construction Product Regulation (marley.co.uk/sustainability). They are also rated 'Excellent' in the BES 6001 Framework Standard for the Responsible Sourcing of Construction Products.

Additionally, all manufacturing locations operate environmental management systems, registered with the CPC as meeting the requirements of BS EN ISO 14001 'Environmental management systems – Specification with guidance for use' and Health and Safety Standard OHSAS 18001, working towards BS EN ISO 45001 certification.

COMPOSITION AND MANUFACTURE

Marley concrete tiles and slates are manufactured from water, cement, aggregates, pigments and polymers to form a concrete tile using a high pressure extrusion and compaction process.

PERFORMANCE

Marley concrete tiles and interlocking slates are tested for resistance to wind driven rain and meet the requirements of BS 5534: 2014 'Code of practice for slating and tiling (including shingles)' with respect to wind loading, when fixed in accordance with our recommendations.

STRENGTH AND DURABILITY

Marley concrete tiles exceed the minimum strength requirements of BS EN 490.

FIRE RESISTANCE

Marley concrete tiles are non-combustible and meet the requirements for external fire performance using test data from external exposure to roof tests (BS 476-3: 2004) as defined in ENV 1187. There are no restrictions on their use under The Building Regulations and they are designated AA in Table 5 of Appendix A Approved Document B, 'Fire Safety'.

ENVIRONMENTAL EFFECTS

Thermal

The thermal resistance (R) of Marley concrete tiles when dry is 0.012m²K/W.

For the purpose of thermal transmittance calculations, the 'R' value above should be substituted by a figure of 0.12m²K/W which includes the roof covering and the airspace behind the tiles or slates. An 'R' value of 0.002m²K/W should be added for the roof underlay.

Frost

Marley concrete tiles and interlocking slates are highly resistant to frost, and meet the requirements of BS EN 490.

Sunlight

Marley concrete tiles and interlocking slates have exceptional colourfast qualities proven over long periods of exposure to UV and sunlight. Enhanced high performance polymer slurry coatings have extended resistance to UV degradation and loss of colour.

Atmospheric pollution

Marley concrete tiles and interlocking slates are suitable for all rural, marine and normal industrial environments. Avoid discharge of gases or liquids from chemical processes onto the surface of the tiles. Resistant to all but the most highly polluted atmospheres where sulphur dioxide levels exceed 70 micrograms/m³ of air.

Electricity

Marley concrete tiles and interlocking slates are electronically insulating. Refer to BS 6651 for recommendations on the protection of buildings against lightning strikes.

BIOLOGICAL EFFECTS

Birds and rodents

Not affected or degraded by birds, rodents or insects.

Mosses and lichens

The growth of mosses and lichens may occur over time, but does not adversely affect their performance. Removal may only be required if they affect the drainage of water from the roof.

Health and safety

When cutting tiles and slates using an angle grinder, measures to reduce the effect of dust should be taken in accordance with the HSE Guidance Note EH 40 'Occupational Exposure Limits', EH 44 'Dust in the workplace: general principles of protection' and HSE Guidance Note EH59/2 (Respiratory Crystalline Silica). For a copy of the Marley concrete tiles and slates MSDS datasheet visit marley.co.uk/sustainability

APPEARANCE

Concrete colour and texture variation can occur due to the manufacturing process. To avoid the risk of colour patching and bands of different shades, Marley concrete tiles and slates should be randomly selected from at least three separate pallets from the same production batch. Ensure there are sufficient quantities of mixed tiles to complete each roof elevation.

Fixing specification

Marley concrete tiles and interlocking slates should be fixed in accordance with the recommendations of BS 5534. The Marley Technical Advisory Service can provide a fixing specification, given the relevant criteria relating to type of roof tile or slate, site location, topography, and building/roof dimensions. Fixing specifications can also be completed online at marley.co.uk/specifying

OTHER CONCRETE TILE COMPOSITIONS

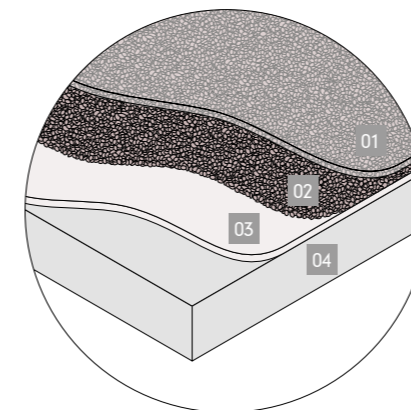

Granular tile composition

- 01 Acrylic top coat
- 02 Granule coating
- 03 Pigmented cement slurry
- 04 Pigmented concrete body

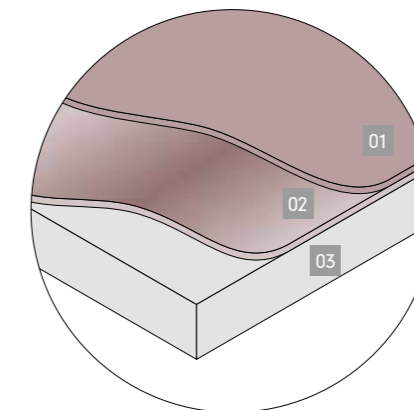

Smooth faced tile with flash composition

- 01 Pigmented paint top coat
- 02 Pigmented flash
- 03 Pigmented concrete body

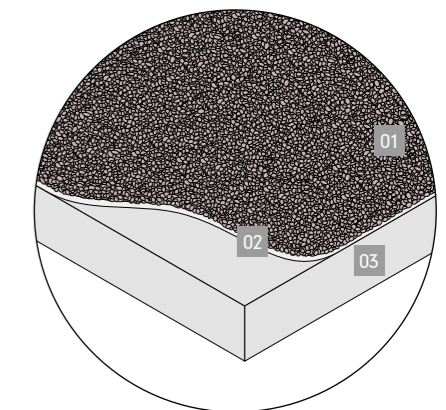

EcoLogic composition

- 01 Photocatalytic titanium dioxide granules embedded into slurry. Granules are fixed as slurry sets in curing process. Granules maximise photocatalytic area.
- 02 Pigmented, cementitious fine grained slurry adhesive. This also contains the photocatalyser to provide additional reactivity.
- 03 Concrete body: Portland cement, recycled aggregates and pulverised fuel ash, together about 50% recycled.



Shingles & Shakes

Each Shingle and Shake is uniquely formed, shaped and coloured by nature itself. Together, on a roof or facade, they create beautiful tapestries of grain, texture and warmth. These subtly change and improve with time, but their performance is constant and durable, as is their enrichment of both building and environment.

Marley Western Red Cedar shingles are a truly renewable and sustainable roofing and cladding material, with one of the lowest carbon footprints of any roofing product.

They are light to transport yet durable and offer a high degree of thermal insulation.

WHY CHOOSE SHINGLES OR SHAKES?

- ▲ Sustainable roofing solutions
- ▲ Proven performance
- ▲ Beautiful appearance
- ▲ Completely renewable material
- ▲ Cost effective
- ▲ Lowest carbon footprint of any roofing material
- ▲ Responsibly sourced

SHINGLES AND SHAKES RANGE

- ▲ Shingles (page 102)
- ▲ Shakes (page 106)

SHINGLES

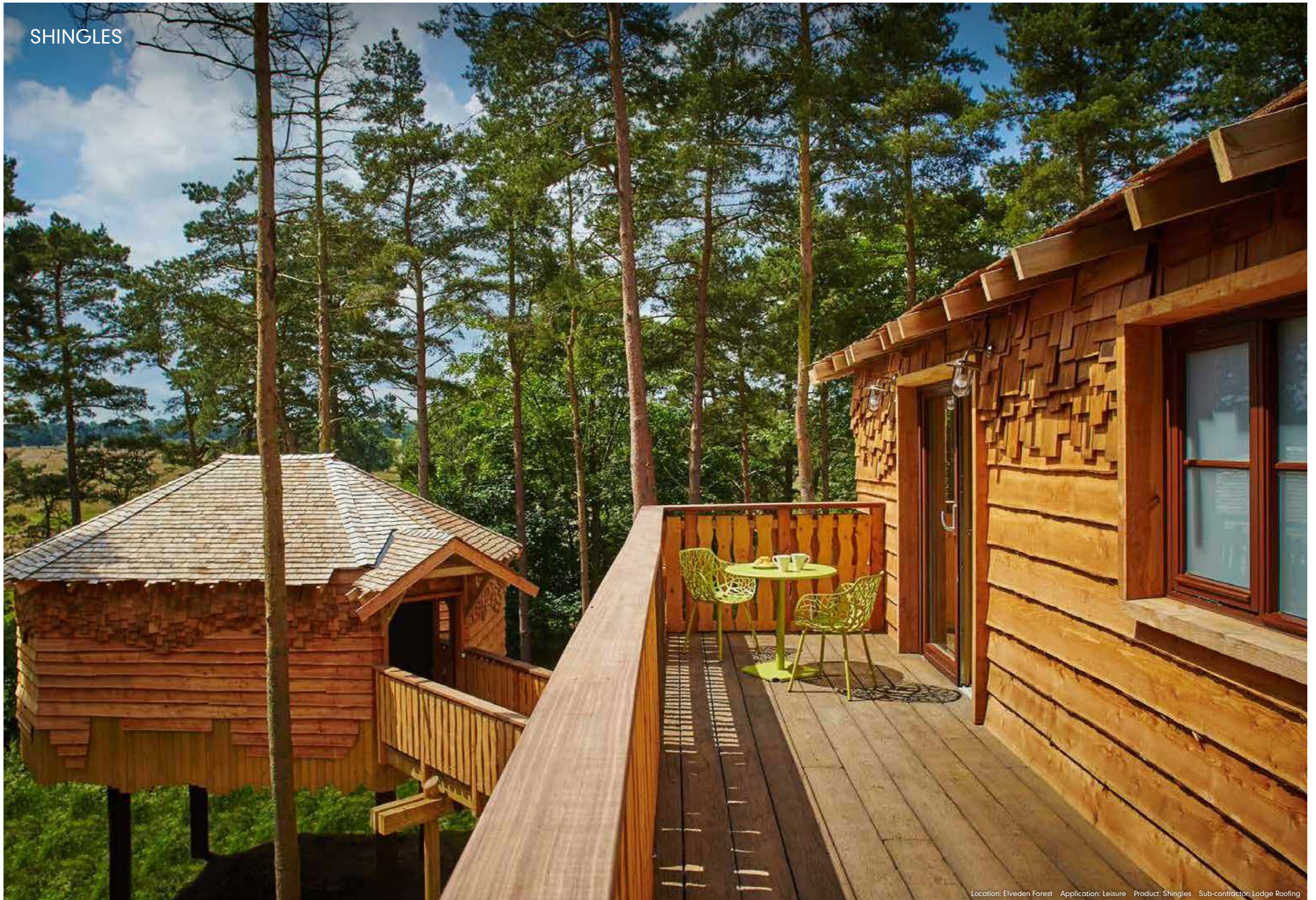

Location: Elveden Forest Application: Leisure Product: Shingles Sub-contractor: Lodge Roofing

SHINGLES

The beauty of cedar shingles can make the ordinary, extraordinary in roofing and cladding applications. Shingles are sawn both sides giving a relatively smooth face and back.



Location: Norfolk Broads Application: Residential Product: Shingles Specifier: Platform 5

TECHNICAL DATA

Length	400mm
Width (random)	75-350mm
Pitch and gauge*	Roofs 95mm (14-21°) 125mm (22-74°) Vertical 175mm (75-90°)
Maximum pitch	90°
Thickness	10mm at the butt, tapering
Covering (bundle)	1.73m ² (95mm gauge) 2.28m ² (125mm gauge) 3.20m ² (175mm gauge)
Laid weight (gauge)	8.1kg/m ² (95mm gauge) 6.1kg/m ² (125mm gauge) 4.0kg/m ² (175mm gauge)
Battens required (net)	10.5 lin.m/m ² (95mm gauge) 8.0 lin.m/m ² (125mm gauge) 5.07 lin.m/m ² (175mm gauge)
Batten size recommended (fixed to BS 5534)	25 x 38mm for rafters/supports not exceeding 450mm centres 25 x 50mm for rafters/supports not exceeding 600mm centres
Fixings	Stainless steel AR nail (31 x 1.8mm)
Authority	Cedar Shake & Shingle Bureau (CSSB)

* The minimum recommended pitch and lap may be influenced by special circumstances, please contact the Technical Advisory Service for further information.

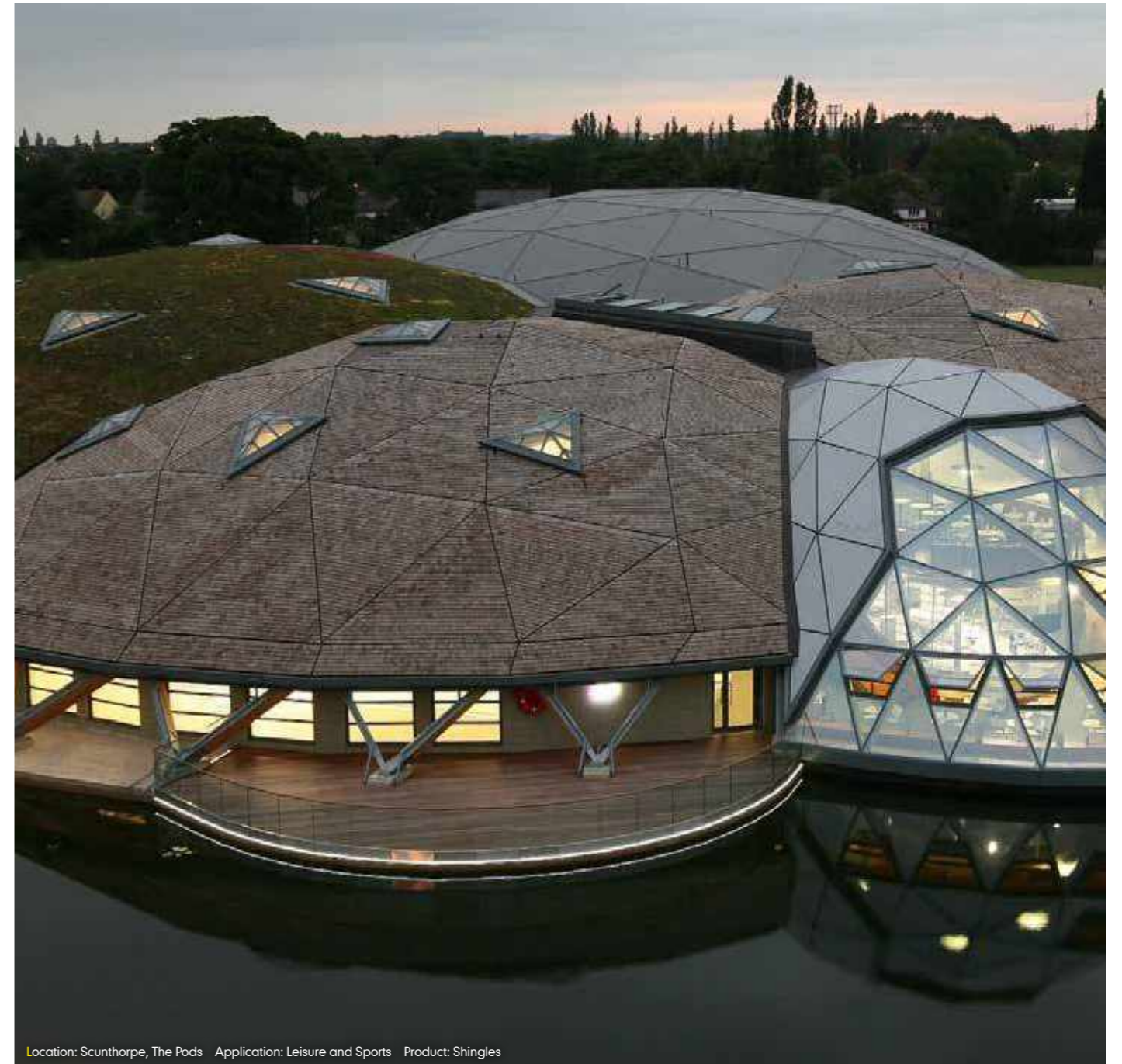

Location: Scunthorpe, The Pods Application: Leisure and Sports Product: Shingles



Location: Tower Hamlets Application: Residential Product: Shingles Specifier: Peter Barber Architects

SHAKES

A shake is hand split with the grain on one face producing a rustic finish and then re-sawn on the back to give a smooth surface to aid fixing.



TECHNICAL DATA

Length	600mm
Width (random)	75-300mm
Pitch and gauge*	Roofs 190mm (20-74°) Vertical 250mm (75-90°)
Maximum pitch	90°
Thickness	19mm at the butt, tapering
Covering (bundle)	1.39m ² (190mm gauge) 2.12m ² (250mm gauge)
Laid weight (gauge)	9.4kg/m ² (190mm gauge) 6.1kg/m ² (250mm gauge)
Battens required (net)	5.3 lin.m/m ² (190mm gauge) 3.5 lin.m/m ² (250mm gauge)
Batten size recommended (fixed to BS 5534)	38 x 25mm for rafters/supports not exceeding 450mm centres 50 x 25mm for rafters/supports not exceeding 600mm centres
Fixings	Stainless steel AR nail (45 x 2.65mm)
Authority	Cedar Shake & Shingle Bureau (CSSB)

* The minimum recommended pitch and lap may be influenced by special circumstances, please contact the Technical Advisory Service for further information.

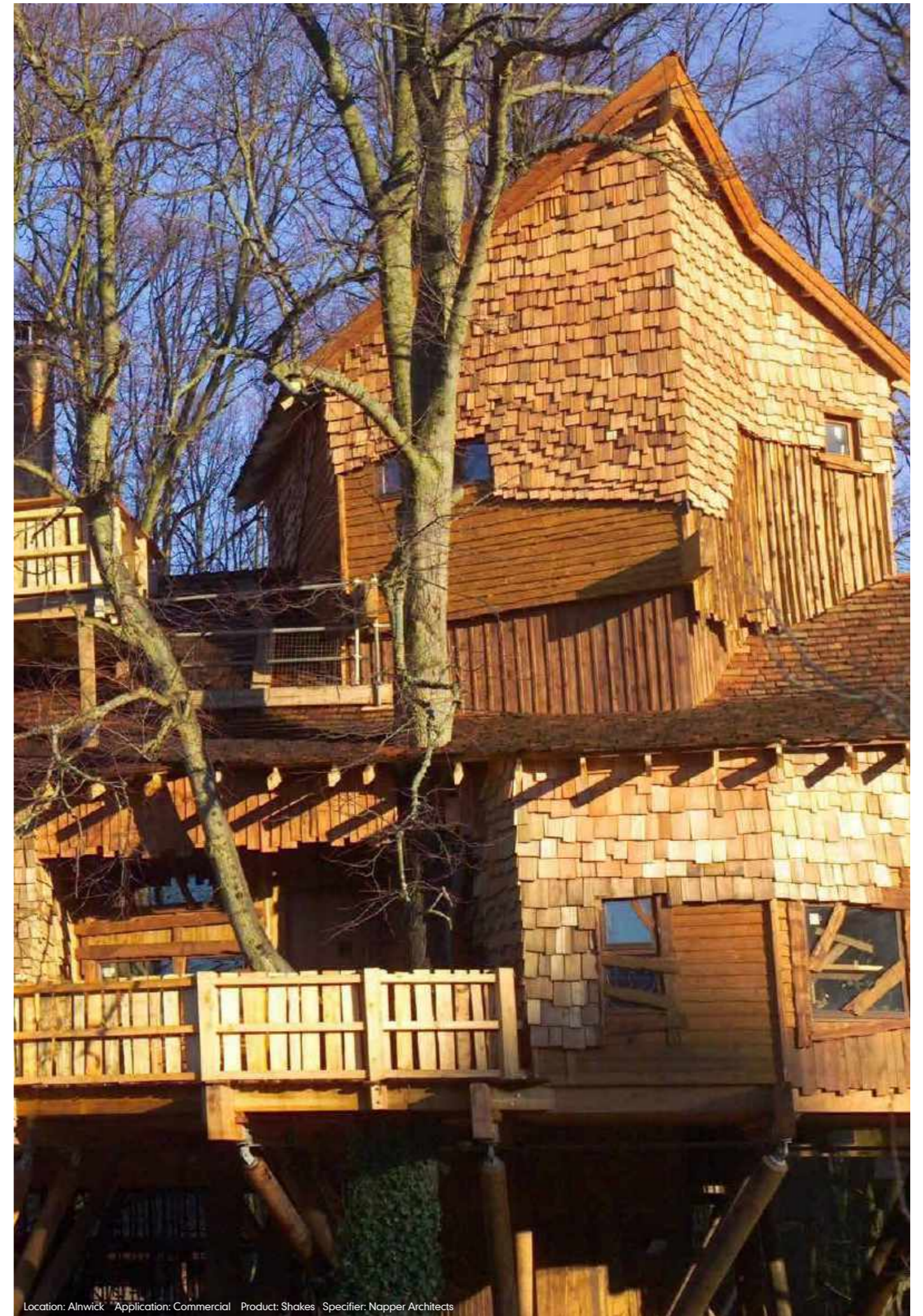

Location: Alnwick Application: Commercial Product: Shakes Specifier: Napper Architects



PROJECT INFORMATION

Location
Ayrshire, Scotland

Application
Residential

Product
Shingles

Specifier
DM Roofing &
Roughcasting

Providing one of the lowest carbon footprints of any widely used building product, Marley shingles not only deliver an aesthetically pleasing and strong finish in keeping with the home's exposed coastal location, they also enabled the roofing contractors to overcome the challenge of working on a non-traditional shaped roofing space thanks to the material's flexibility during installation.

Approximately 300m² of shingles were specified for the roof covering, which has helped create an eye-catching property that sits seamlessly within its surroundings. In addition, the shingles specified were preservative treated, which not only protects against wood-rotting fungi and insect attacks, but also lets the shingles weather naturally without the staining sometimes associated with other treatments, and can deliver an extended life span of 40 years.

▲ Find more case studies at marley.co.uk/case-studies

PROPERTIES & PERFORMANCE
SHINGLES & SHAKES

QUALITY AND ENVIRONMENT

Marley sources its Western Red Cedar Shingles and Shakes from manufacturers who are members of the Cedar Shingle and Shake Bureau. All Marley Cedar Shingles have the 'Certi-Grade' quality assurance label and have PEFC Chain of Custody to ensure both a legal and sustainable product.

PEFC

Marley has full chain of custody. The PEFC (Programme for the Endorsement of Forest Certification schemes) is an internationally recognised organisation that ensures that our timber is purchased from both legal and sustainable sources. This scheme traces the timber from forest to end use. PEFC also acts as an umbrella organisation, incorporating national schemes such as CSA (Canadian Standards Authority) and SFI (Sustainable Forestry Initiative).

GRADES

Cedar Shingles are produced in 3 grades. These are referred to as Blue Label, Red label and Black Label. Marley only recommends the use of Blue Label shingles in the UK. They are:

- ▲ 100% Heartwood – this is the durable part of the tree (sapwood easily decays)
- ▲ 100% Edge grain – this ensures the shingle is stable, doesn't cup and again more durable
- ▲ 100% All clear – this ensures the shingle is free of defects such as knots

Marley Shingles have the Certi-grade® blue label, and Marley Shakes have the Certi-split® label to ensure the highest standard in quality. Only members of the Cedar Shingle and Shake Bureau are able to use the Certi®-label. Bureau members are bound by rigid quality standards and the label serves as a quality control mechanism.

SIZE

Shingles come in random widths varying from 75mm to 350mm. They are produced in 400mm lengths.

The most typical shingle is the FiveX.

- ▲ FiveX – 400mm (16") Shingles - stocked product
- ▲ Perfections – 450mm (18") Shingles - special order
- ▲ Royals – 600mm (24") Shingles - special order

ANATOMY
OF A SHINGLE

Smooth face

Sawn both sides

Smooth back

Tapered end



PROPERTIES & PERFORMANCE

SHINGLES & SHAKES

LIFESPAN AND DURABILITY

Shingles are naturally durable, but for maximum life expectancy, Marley recommends that Cedar Shingles are preservative treated.

SOUND

Western Red Cedar is particularly effective in a sound-damping capacity and provides effective, economical sound insulation.

INSULATION

Due to Western Red Cedar's low density and coarse texture, it has good insulation properties. Western Red Cedar is recognised as the best thermal insulator amongst the commonly available softwoods, and is far superior to brick, concrete and steel.

It is widely used in saunas because of its low thermal conductivity; with a value of $K=0.1067 \text{ W/mK}$ at 12% moisture content.

CLIMATE

Shingles are resistant to frost and nail impact. Once installed, they are resistant to high winds exceeding hurricane force (each shingle is nailed twice).

ANATOMY OF A SHAKE

Hand split finish

Tapered end



WOOD FOR GOOD

Renewable and sustainable

Marley western red cedar shingles represent a truly renewable and sustainable roofing material with one of the lowest carbon footprints of any widely used pitched roofing or cladding material. BREEAM - the BRE's lifecycle analysis system - gives our shingles an A* rating when used for vertical cladding.

The manufacture of shingles and shakes ensures optimum utilisation of forest resources. Parts of the log that are unsuitable for sawn timber - and might otherwise be wasted - can be used, and due to their exceptionally light weight, shingles require less energy during the manufacturing and transport phases of their life than most other roofing or cladding materials.

Carbon cycle

There is a drive towards zero carbon homes. Timber can contribute significantly with the carbon sink effect of the forests, the carbon storage of the timber, and as a substitute for carbon intensive materials.

- ▲ Every 1m^3 of timber absorbs 1 tonne of CO_2
- ▲ Timber energy is CO_2 neutral (only the CO_2 absorbed is returned back to the atmosphere)
- ▲ There is little waste in manufacturing, as the by-products can be used for energy generation in bio-mass power plants used to generate power for the site or the grid

Detailing

DRY FIX AND VENTILATION SYSTEMS

SYSTEMS OVERVIEW 112
SYSTEMS SELECTOR 114







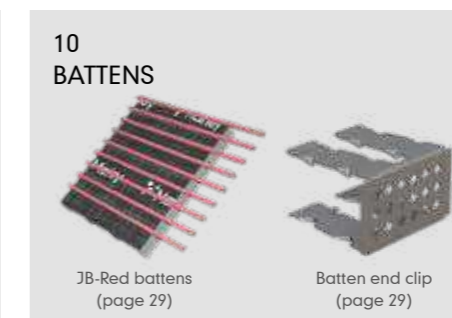
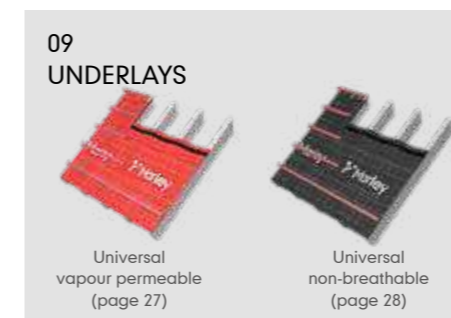
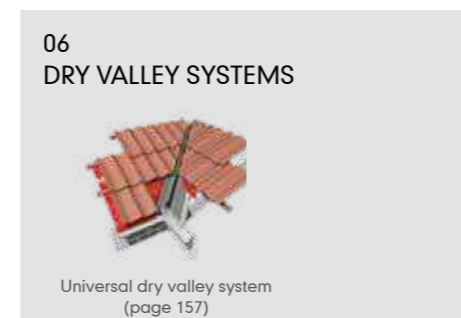
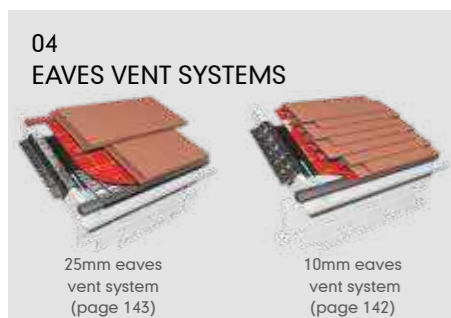
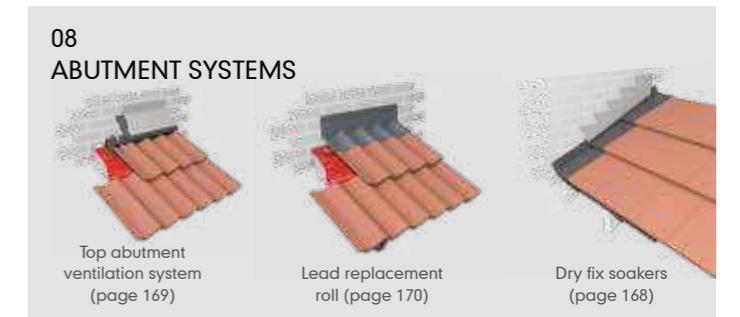
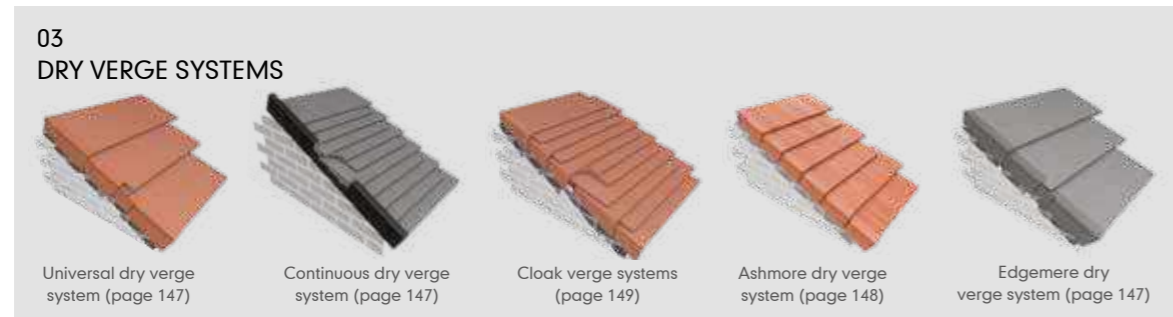
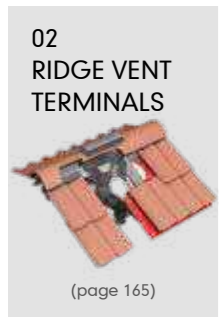
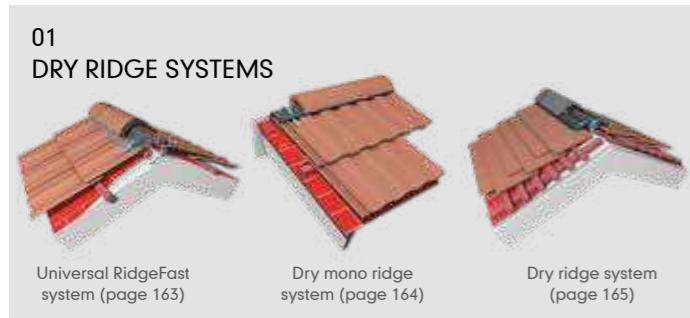
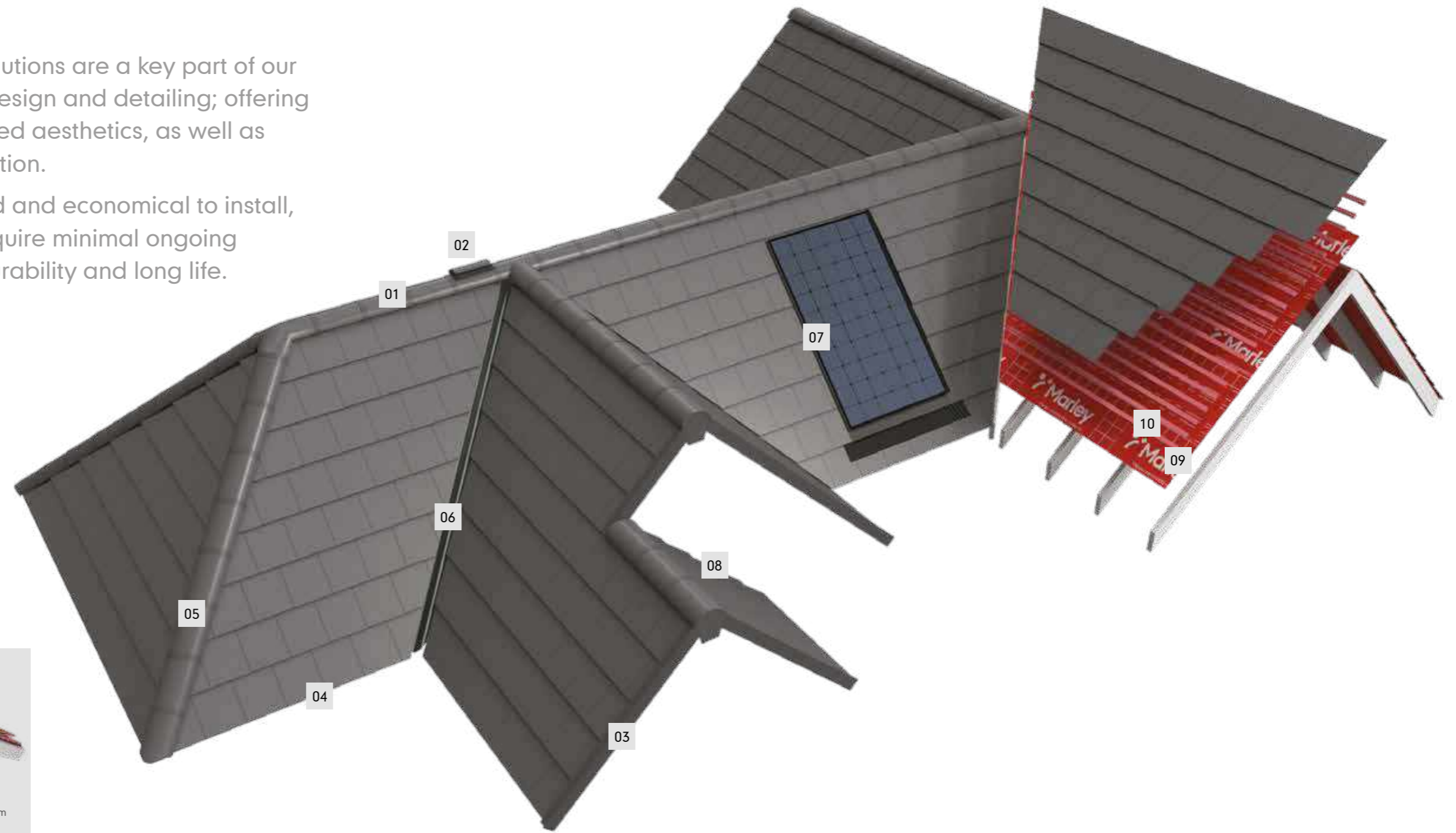









SYSTEMS OVERVIEW

Our dry fix, ventilation and solar solutions are a key part of our roof system, enabling flexibility in design and detailing; offering weatherproofing, security and refined aesthetics, as well as providing excellent levels of ventilation.

They are also quick, straightforward and economical to install, and for the building owner, they require minimal ongoing maintenance but give maximum durability and long life.



DRY FIX & VENTILATION SYSTEMS SELECTOR

																
	CLAY PLAIN TILES	LINCOLN	EDEN	CONCRETE PLAIN TILES	EDGEMERE RANGE	ASHMORE	LUDLOW PLUS	ANGLIA	DOUBLE ROMAN	LUDLOW MAJOR	ECOLOGIC LUDLOW MAJOR	MENDIP	MENDIP 12.5	WESSEX	MODERN RANGE	SHINGLES & SHAKES
UNIVERSAL ACCESSORIES																
10mm eaves vent system	•	•	•	•	•	•	•	•	•	•	•	•	•	•	•	
25mm eaves vent system	•	•	•	•	•	•	•	•	•	•	•	•	•	•	•	
Dry verge		•			•		•	•	•	•	•	•	•	•	•	
HipFast	•	•	•	•	•	•	•	•	•	•	•	•	•	•	•	
RidgeFast	•	•	•	•	•	•	•	•	•	•	•	•	•	•	•	
Tile vent					•		•	•	•	•	•	•	•	•	•	
Dry valley	•	•	•	•	•	•	•	•	•	•	•	•	•	•	•	
Underlays	•	•	•	•	•	•	•	•	•	•	•	•	•	•	•	
Bonding gutters	•	•	•	•	•	•	•	•	•	•	•	•	•	•	•	
DRY VERGE SYSTEMS																
Cloak verge system	•	•		•					•			•				•**
Edgemere dry verge					•	•										
Continuous dry verge systems	•			•	•	•										
Ashmore dry verge																
DRY HIP SYSTEMS																
Dry hip system					•	•	•	•	•	•	•	•	•	•	•	
DRY VALLEY SYSTEMS																
Plain tile valley	•			•												
VENTILATED DRY RIDGE SYSTEMS																
Ventilated dry ridge					•	•	•	•	•	•	•	•	•	•	•	
Ventilated dry mono ridge					•	•	•	•	•	•	•	•	•	•	•	
Ridge roll vent																•
ABUTMENT SYSTEMS																
Top abutment ventilation system		•			•	•	•	•	•	•	•	•	•	•	•	
Dry soakers	•			•	•	•	•									•
Flexfast lead replacement roll	•	•	•	•	•	•	•	•	•	•	•	•	•	•	•	
VENTILATION TERMINALS																
Gas vent ridge terminals				•	•	•	•	•	•	•	•	•	•	•	•	
Ridge vent terminals				•	•	•	•	•	•	•	•	•	•	•	•	
In-line vents and contour vents	•			•	•	•	•	•	•	•	•	•	•	•	•	
Tile vent terminals		•	•		•					•	•	•	•	•	•	
Ventilation roof tile						•										
Ridge vent for condensing boiler					•	•	•	•	•	•	•	•	•	•	•	

Suitability can be dependent on rafter length and roof pitch requirements. Please contact the Technical Advisory Service for assistance.
 * Mendip cloak verge system is not suitable for Mendip 12.5°. ** Suitable for Modern only.

Knowledge

DESIGN CONSIDERATIONS		DESIGN DETAILING	
117	INTRODUCTION	141	EAVES
120	RECOMMENDED DESIGN PROCEDURE	146	VERGES
122	LEGISLATION, GUIDANCE & REFERENCE	151	HIPS
124	BS 5534 SOLUTIONS	156	VALLEYS
126	BS 8612 SOLUTIONS	161	BONDING GUTTERS
128	BS 5250 VENTILATION GUIDANCE	162	RIDGES
134	WEATHER RESISTANCE	167	ABUTMENTS
138	THERMAL INSULATION	171	ROOF SLOPES
140	OTHER REGULATIONS & STANDARDS	175	SPECIAL DETAILS
		180	SLATE ACCESSORIES

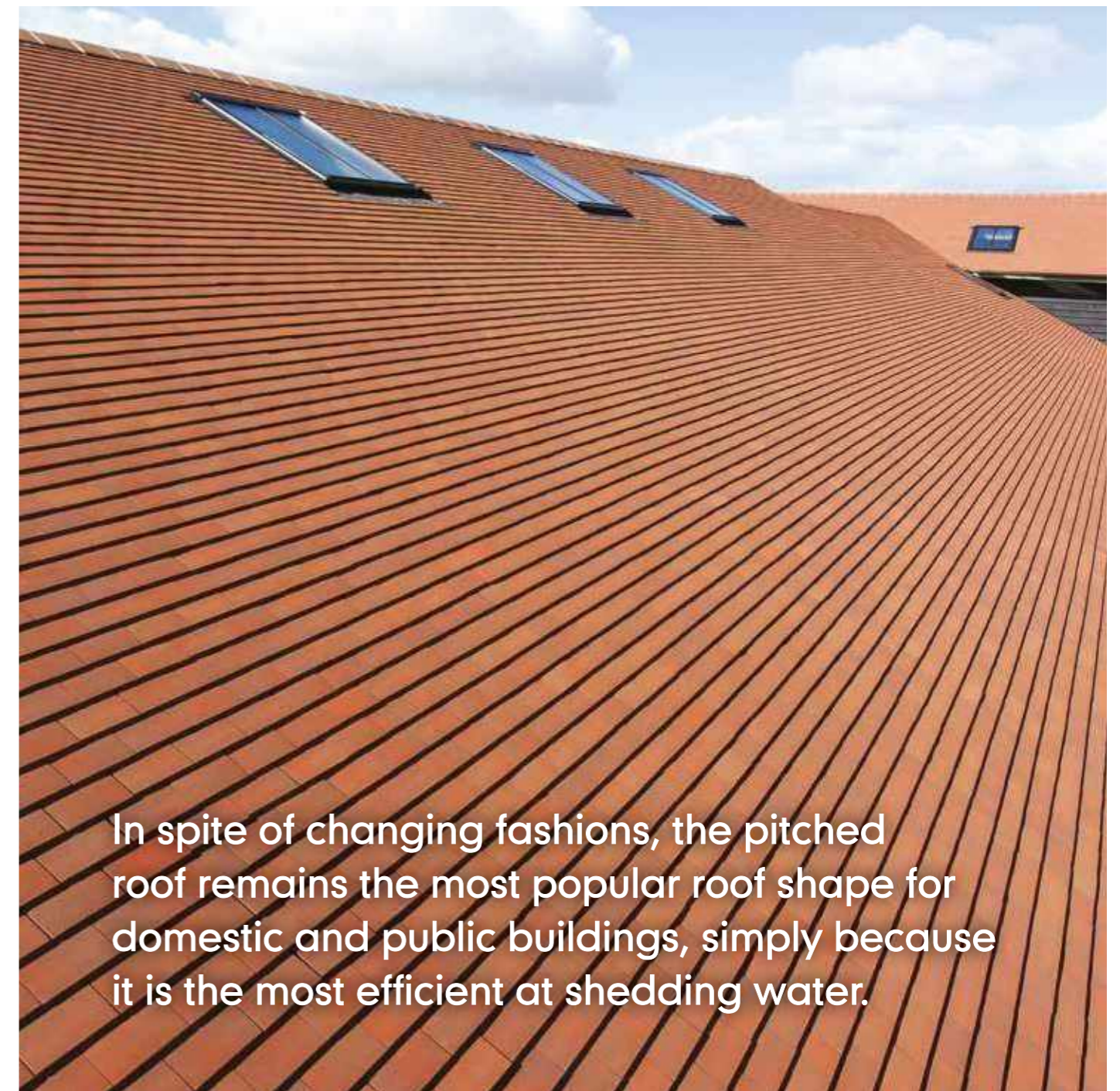

In spite of changing fashions, the pitched roof remains the most popular roof shape for domestic and public buildings, simply because it is the most efficient at shedding water.



Also, the overlapping roof tile or slate is still a highly popular covering because it is durable, inexpensive, easy to lay and widely available.

Moreover, their modular design and wide variety of colours, textures and shapes allow them to be used on a vast range of roof shapes and designs with confidence, flair and economy.

ROOF SHAPE

The pitched roof covered with modular tiles or slates offers the designer a vast choice of roof designs. Whatever the shape and function of the space beneath, it can be the design and detailing of the roof that has the greatest influence on the appearance and effect of the building as a whole. Some examples of roof shapes are shown here, but many more are possible.

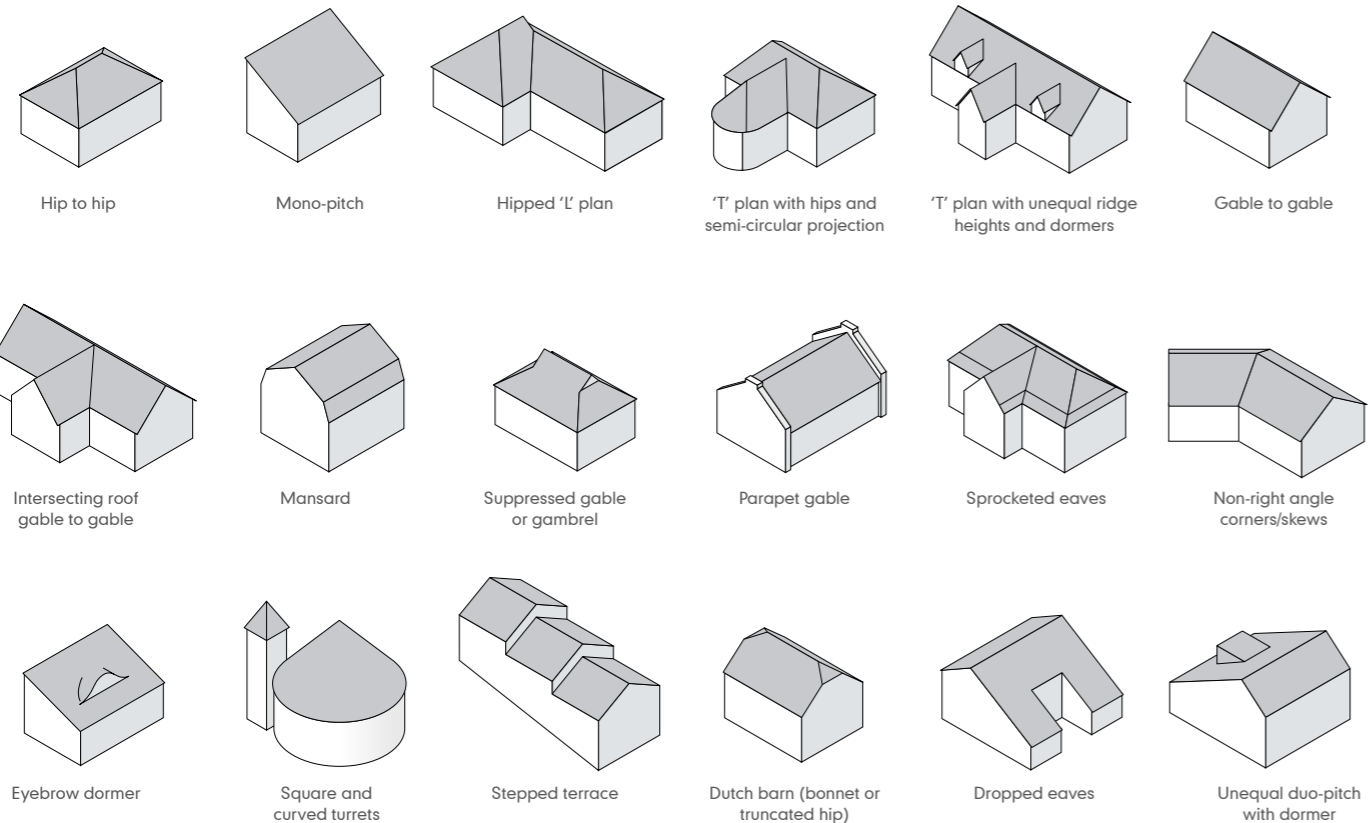

THE CONTEXT OF THE ROOF

The physical and environmental context of a building will often establish a range of pre-conditions for the design of a pitched roof and its covering.

Before consulting the Building Regulations, the specifier should consider the following factors:

ENVIRONMENTAL
General climate
Microclimate
Exposure
PERFORMANCE
Resistance to structural movement
Resistance to wind uplift
Fire resistance
Resistance to thermal movement
Resistance to driving rain
Acoustic insulation
Building ventilation
Roof ventilation
Condensation prevention
Impact resistance
Durability
Resistance to atmospheric pollution
Bird, rodent and insect resistance
Thermal insulation
AESTHETICS
Resistance to structural movement
Scale of building elements
Use of roof space
Roof pitch
Response to function
Scale of covering elements
Colour
Texture
Local (planning) requirements
Shape

The use of the roof as a 'solar collector' for PV modules can also influence its location and orientation.

DESIGN CRITERIA

The design of a pitched roof is dictated initially by the shape of the building, the span between the structural elements and the use to be made of the space enclosed by the roof.

After structure and function have been taken into account, the design of the roof may be modified by other considerations, such as weathering and aesthetics.

A useful model to consider when designing the roof is covered by the 4 key criteria below.

STRUCTURE – WILL THE ROOF COLLAPSE OR BLOW AWAY?

Adequacy of support
Wind loads and attachment
Deflection calculations
Movement

WEATHERPROOFING – WILL THE ROOF LEAK?

Determine site exposure
Determine roof construction
Perimeter details
Rainwater goods

PERFORMANCE – WILL THE ROOF PERFORM?

Fire performance
Acoustic performance
Corrosion resistance
Durability and sustainability

HYGROTHERMAL – WILL THERE BE CONDENSATION OR EXCESSIVE HEAT LOSS?

Thermal calculations
Condensation risk analysis
Air leakage
Ventilation

Designers are advised to consider the following steps when commencing a roof design incorporating Marley products.

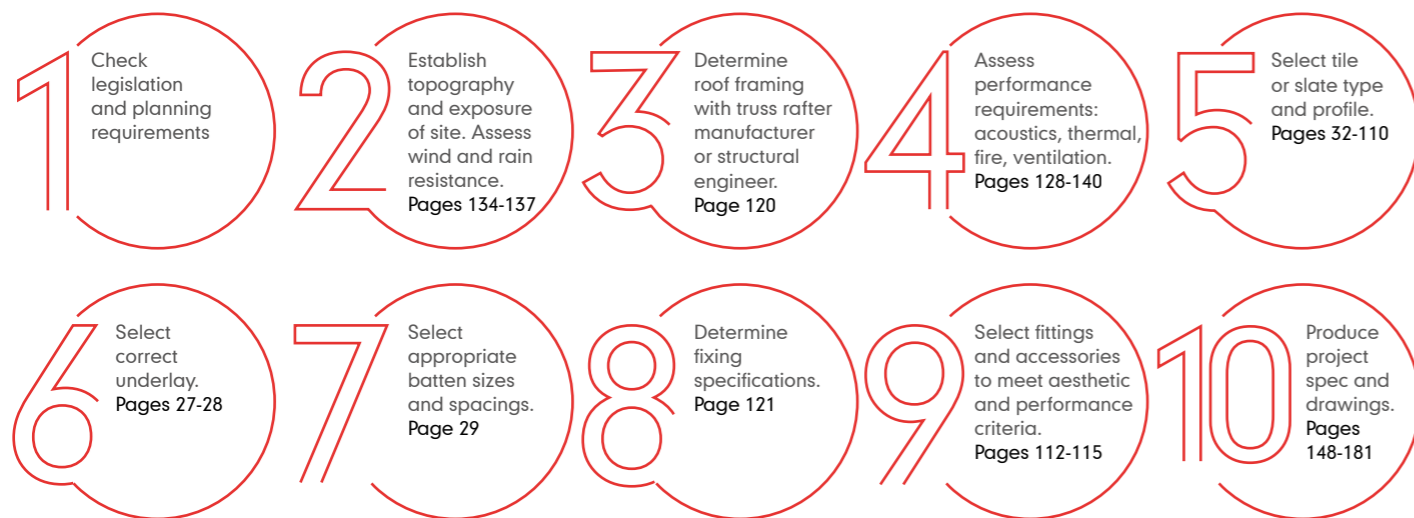

Reference should also be made to the latest versions of BS 5534 'Slating and tiling for pitched roofs and vertical cladding – Code of practice', and to BS 8000: Part 6: 'Workmanship on Building Sites: Code of Practice for slating and tiling of roofs and claddings' and BS 5250 'Code of practice for control of condensation in buildings'.

The following information is provided for guidance only. Designers should ensure that they make all the necessary calculations and take into account all aspects of the specific project design and location.

STEP 1: LEGISLATION AND PLANNING

Guidance on legislation is given on pages 00-00. Planning permission for roofs may be necessary in certain areas and is subject to Local Authority planning, policy and control.

STEP 2: EXPOSURE, WIND AND RAIN

Establish the exposure zone of the site by reference to the map on page 00. This divides the UK into four categories of exposure to driving rain and is based on rain penetration data from BS 8104, 'Code of practice for assessing exposure of walls to wind-driven rain' and BRE Report 262 'Thermal insulation: avoiding risks'. The map applies to buildings of up to 12 metres in height at the ridge.

Where the roof slope exceeds 6 metres in length and/or the site is rated to be in a severe exposure category, guidance on the suitability of the roof tile should be confirmed by contacting the Marley Technical Advisory Service.

Calculate the wind suction loading either in accordance with BS EN 1991: Part 1-4 or use the design calculations on wind loads in BS 5534. Alternatively, see our online calculator for a full fixing specification.

STEP 3: ROOF SHAPE AND STRUCTURE

Determine design of roof and configuration of roof supports with structural engineer and truss rafter manufacturer.

Ensure that the roof structure is adequate for the total weight of the tiles as laid, the calculated wind loading and any other relevant loading criteria (see page 136). Weights as laid are shown on the appropriate product pages.

As a rule, roofs that include hips and/or valleys should have a steeper pitch than simple mono- or duo-pitch roofs. At hips or valleys, the effective pitch of the hip/valley is reduced by 5-10°, making it more vulnerable to water penetration.

STEP 4: ASSESS PERFORMANCE AGAINST REGULATORY REQUIREMENTS

Roof performance criteria will vary according to design, building function etc., further guidance on controlling condensation risk is shown on pages 128-133 and on Thermal, page 138. Acoustics, Fire, Drainage, Chimneys and Flues and information on the Regulations in Scotland and Northern Ireland are shown in brief on page 140.

STEP 5: TILE SELECTION

The choice of roof covering is a combination of planning, aesthetic and performance criteria. The key factors are shape, size, colour, texture, material and sustainability, see pages 32-110.

STEP 6: UNDERLAY

Select a roofing underlay in accordance with the recommendations of BS 5534.

Marley offer vapour permeable (LR) and non-breathable Universal (HR) underlays, both with integral lap sealing.

The underlay may be either fully supported or unsupported (draped), should be of adequate strength, durable and resistant to water penetration. Unsupported underlay should also be resistant to wind uplift and 'ballooning'. There are two categories: HR non-vapour permeable underlay (for example, Marley's non-breathable underlay) as described in BS 5534; and LR, vapour permeable underlay. In the case of LR underlays (for example Marley's vapour permeable underlay), the designer must ensure that the manufacturers' stated water vapour resistance values are in accordance with BS 5250 and a Condensation Risk Analysis. These types of underlay should comply with BS EN 13859-1, or have Third Party accreditation, such as a BBA certificate.

Select the minimum horizontal lap for the underlay appropriate to the rafter pitch from Table 1.

TABLE 1

Rafter pitch	Minimum horizontal lap for underlay		
	unsupported (mm)	fully supported (mm)	vertical (mm)
12.5° to 14°	225	150	100
> 15°	150	100	100

STEP 7: BATTENS

Battens should be selected and graded in accordance with BS 5534.

TABLE 2

Application	Basic minimum size of batten			
	Up to 450mm span		451- 600mm span	
	Width (mm)	Depth (mm)	Width (mm)	Depth (mm)
Clay and concrete tiles				
Double lap	38	25	38	25
Single lap	38	25	50	25

Where boarding or rigid sarking is used, counterbattens are required over the boarding, either above or below the underlay, to allow any water that penetrates the tiling to drain away to the eaves gutter.

Counterbattens should be not less than 19mm wide x 25mm deep. The centres of counterbattens should coincide with the rafters or trusses.

When fixing vertically, the use of counterbattens improves alignment and drainage and reduces the number of direct fixings into a masonry wall. If necessary, however, battens can be secured directly to the wall using special fixings.

STEP 8: FIXING SPECIFICATIONS

A full fixing specification should be obtained from the Marley Technical Advisory Service, or by visiting our web site - marley.co.uk/specifying. A fixing specification can also be determined by using calculations in BS 5534, which states that all single lap roof tiles must be mechanically fixed irrespective of building size and location, using the manufacturer's recommended fixings. Table 3, below, shows the minimum fixing specification only, subject to location.

TABLE 3

Roof pitch (°)	Minimum fixing specification
Clay (double lap) plain tiles	
30-59° (Acme single camber, Hawkins)	Two courses of tiles at eaves and top courses twice nailed. In addition, all perimeter tiles and every fifth course twice nailed.
35-59° (Acme double camber, Ashdowne)	Two courses of tiles at eaves and top courses twice nailed. In addition, all perimeter tiles and every fifth course twice nailed.
60° and above	All tiles twice nailed.
Concrete plain tiles	
35-59°	Two courses of tiles at eaves and top courses twice nailed. In addition, all perimeter tiles and every fifth course twice nailed.
60° and above	All tiles twice nailed.
Interlocking (single lap) tiles	
15-22°	All perimeter tiles clipped (additional fixings may be required subject to calculation).
22.5-44°	Every tile to be mechanically fixed.
45-54°	All tiles to be fixed with at least one nail (additional clipping may be required subject to calculation).
55° and above	All tiles to be nailed and clipped.

STEP 9: FITTINGS AND ACCESSORIES

Check that any fittings or accessories specified are suitable for the roof design and its associated performance requirements, by referring to pages 112-115, or by contacting the Technical Advisory Service.

Before contemplating any pitched roof design (or any other roof design), the designer must be aware of the current legislation, as well as the design requirements and standards that govern and influence the style, parameters, performance, products and construction of the roof.



The following section summarises many of the relevant documents, but is by no means exhaustive.

Designers are advised to check the latest updates to the Approved Documents by accessing the DCLG website: www.planningportal.gov.uk

Or in the case of the Welsh Approved Documents: www.gov.wales

Or in the case of the Scottish Regulations: www.gov.scot

Or the Northern Ireland Approved Documents: www.dfpni.gov.uk

BUILDING REGULATIONS

These are mandatory regulations in England and are generated and approved by the Department for Communities and Local Government (DCLG).

Since 31 December 2011, the Welsh Assembly has had responsibility for setting Building Regulations in Wales.

In Scotland they are generated and approved by the Scottish Government and in Northern Ireland, by the Department of Finance and Personnel.

They must be complied with for all new build and a great deal of refurbishment work. They consist of the Building Regulations 2010 (as amended) for England, the Building Regulations 2010 (Wales) (as amended), the Building (Scotland) Regulations 2004 (as amended), and the Building Regulations (Northern Ireland) 2012.

Compliance with these regulations is the responsibility of the building designer, who may be the owner of the building, his appointed architect, a structural engineer appointed by the owner or his architect or, in the case of small buildings, the actual builder.

The increasing complexity of roof constructions and the codes that govern their design has led many building designers to request the specialist services of a roof designer. In the case of pitched trussed rafter roofs, design or design-and-build sub-contracts may also be left to a trussed rafter designer.

The Approved Documents of the Building Regulations (England), the Approved Documents of the Building Regulations (Wales), the Technical Handbooks (domestic and non-domestic) (Scotland) and the Technical booklets (Northern Ireland) provide practical guidance for some of the common building situations in respect of the requirements for materials and workmanship.

KEY STANDARDS AND REGULATIONS

VENTILATION

England
Part F1 'Means of Ventilation'

Wales: Part F 'Ventilation'

Northern Ireland: Technical Booklet K 'Ventilation'

Scotland: Technical handbook, Section 3 'Environment'

See 'BS 5250 – ventilation guidance', pages 128-133

MOISTURE

England: Part C 'Site Preparation and Resistance to contaminants and Moisture'

Wales: Part C 'Resistance to Contaminants and moisture'

Scotland: Technical handbook, Section 3 'Environment'

Northern Ireland: Part C 'Site Preparation and Resistance to Contaminants and Moisture'

See 'Weather resistance' pages 134-137 and 'BS 5250 – ventilation guidance', pages 128-133

THERMAL

England and Wales: Part L 'Conservation of fuel and power' (L1A, L1B, L2A, L2B)

Wales: Part L 'Conservation of fuel and power' (L1A, L1B, L2A, L2B)

Scotland: Technical handbook, Section 6 'Energy'

Northern Ireland: Part F 'Conservation of fuel and power' (F1 and F2)

See 'Thermal insulation' page 138 and 'BS 5250 – ventilation guidance', pages 128-133

FIRE

England and Wales:
Part B 'Fire Safety'

Wales: Part B: 'Fire Safety'

Scotland: Technical handbook, Section 2 'Fire'

Northern Ireland:
Part E 'Fire Safety'

BS 5250

'Control of Condensation in Buildings' *

Describes the causes and effects of surface and interstitial condensation in buildings and gives recommendations for its control (see pages 128-133 for control of condensation in roofs).

*in course of revision

BS 5534

BS 5534: 'Slating and Tiling for pitched roofs and vertical cladding – Code of practice'

Gives recommendations for the design, materials, application, installation and performance of slates and tiles (see also pages 124-125).

BS 8000-6

'Workmanship on building sites. Code of practice for slating and tiling of roofs and claddings' *

Applies to the laying and fixing of clay and concrete tiles, natural and fibre cement slates and their associated fixings and accessories.

*in course of revision

BS 8612

'Dry fixed ridge, hip, and verge systems for slating and tiling. Specification'

Specifies the performance requirements and methods of test for dry-fixed ridge, verge and hip systems.

BRITISH STANDARDS

A British Standard is a published document that contains a technical specification or other precise criteria designed to be used consistently as a rule, guideline, or definition. They are a summary of best practice and are created by bringing together the experience and expertise of all interested parties – the producers, sellers, buyers, users and regulators of a particular material, product, process or service

Standards are designed for voluntary use and do not impose any regulations. However, laws and regulations may refer to certain standards and make compliance with them compulsory.

The principal British Standards relevant to this document are:

BS 5534: 'Slating and tiling for pitched roofs and vertical cladding- Code of practice'

Gives recommendations for the design, materials, application, installation and performance of slates, tiles, shingles and shakes and their associated fittings and accessories used in the construction of pitched roofs and vertical cladding applications. Rain and wind resistance, along with durability, thermal insulation, the control of condensation, fire resistance, sound, environmental and health and safety issues are also considered.

To be read in conjunction with BS 8000-6.

BS 8000-6: 'Workmanship on building sites. Code of practice for slating and tiling of roofs and claddings'

Applies to the laying and fixing of clay and concrete tiles, natural and fibre cement slates and their associated fixings and accessories. Common Arrangement of Work Section (CAWS) classifications H60, H61, H62 and H65

BS 5250: 'Code of practice for control of condensation in buildings'

Describes the causes and effects of surface and interstitial condensation in buildings and gives recommendations for its control (see pages 00-00 for Control of Condensation in Roofs).

BS 8612: 'Dry-fixed ridge, hip and verge systems for slating and tiling - Specification'

BS 8612: 2018 is a British Standard that specifies the performance requirements and methods of test for dry-fixed ridge, hip and verge systems connected to timber ridge/hip battens, ridge boards or hip rafters, and verge systems fixed to battens, which are installed with slating or tiling. BS 8612 is to be incorporated into BS 5534.

HEALTH AND SAFETY

To ensure safe working practices during construction, the designer should consider relevant safety regulations. These include the Construction (Design and Management) Regulations and the Health and Safety Executive's approved code of practice for management of health and safety at work, including HSG 33 'Health and safety in roof work'.

OTHER GUIDANCE DOCUMENTS

Certain advisory bodies such as the National Federation of Roofing Contractors (NFRC), Roof Tile Association (RTA), National House Building Council (NHBC), Loss Prevention Council, Building Research Establishment Ltd (BRE) and Timber Research and Development Association (TRADA) also produce recommendations and guidance on roof construction which should be considered.

BS 5534 was substantially updated and improved in 2014 (with amendments in 2015 and 2018) and is the British Standard Code of practice for slating and tiling. It provides the industry with guidance on best practice relating to the design and installation of pitched roofs covered by slates and tiles, and contains a vast array of technical information, ranging from the specification of timber battens, to methods of fixing, through to resistance to wind uplift calculations.

BS 5534 KEY FACTORS

Extreme weather events such as gale force winds, driving rain and flooding are on the rise and placing more strain on the UK roofscape than ever before. Recent updates to the British Standard for Slating and Tiling ultimately ensure that the UK is more closely aligned with the standards and practices outlined in the structural Eurocodes which incorporate guidance on updated wind loading criteria for roofs.

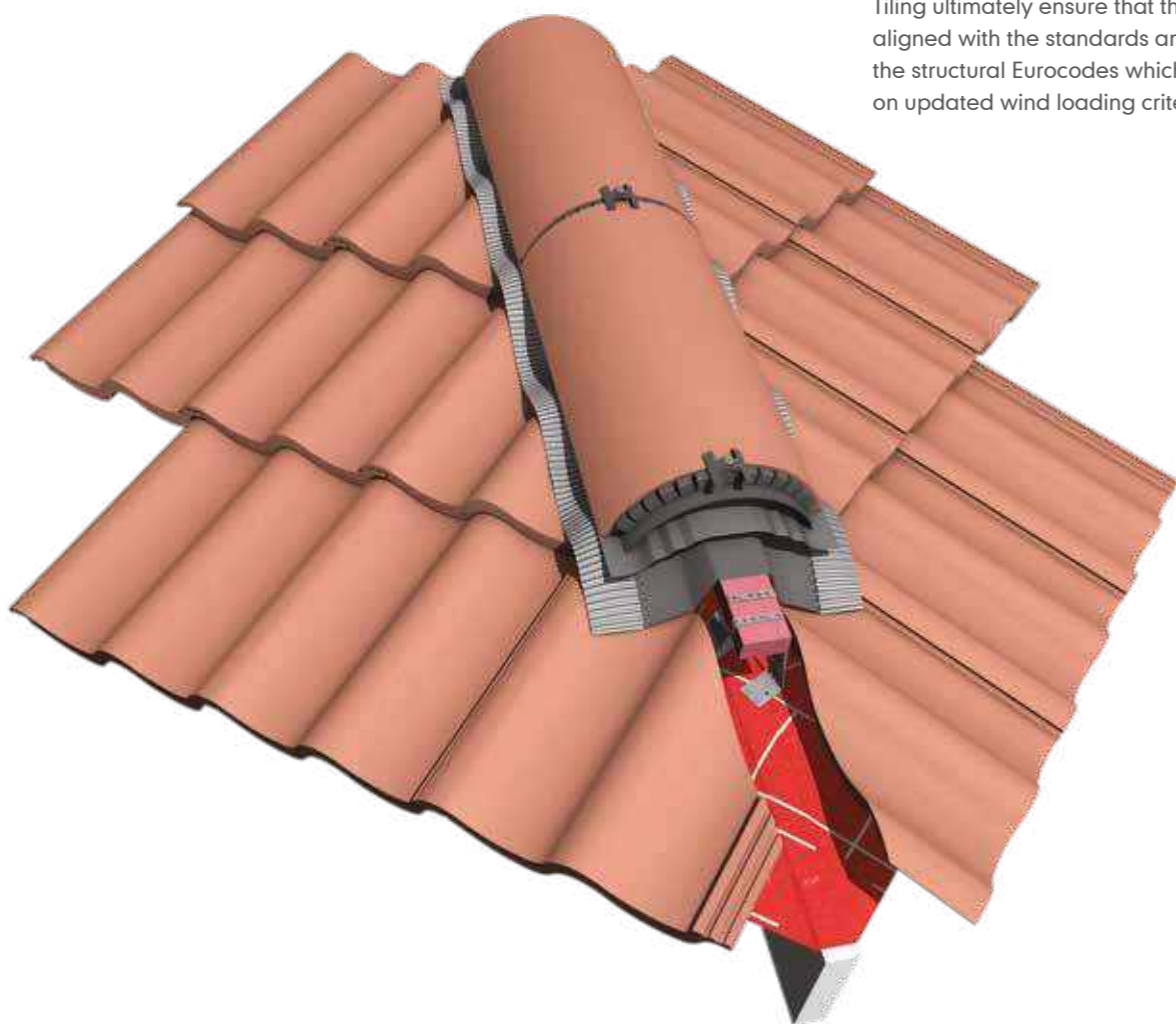

FIXING

Every single lap tile must be mechanically fixed

Changes to wind load calculations in accordance with BS 5534 require all single lap tiles to be mechanically fixed with either a clip or a nail. The proportion of each will depend on a number of factors which can be calculated by the Marley Fixing Specification Service.

Solution: SoloFix – the one-piece clip and nail for all standard interlocking tiles

Clipping, with two-piece aluminium or stainless steel clips and nails, can be time-consuming, and time is money.

Marley launched the SoloFix one-piece clip and nail for all standard interlocking tiles, providing an affordable fixing that not only installs up to 30% faster than traditional clips, but delivers outstanding strength and durability.



SMALL TILE CUTS

Marley head and tail clip packs, and secret cut tile clip packs provide an effective solution for mechanically fixing small tile cuts at both the hip and valley.

MORTAR BEDDING

Mortar can no longer be used as the sole means of fixing roof tiles and fittings

With BS 5534 guidance, the use of mortar as a sole means of fixing roof tiles and fittings is insufficient.

Not only should careful consideration be given to the creation of a suitable roof mortar through the correct sand and cement specification and mix ratio, but tiles or fittings bedded with this mortar must also be accompanied by mechanical fixings, wherever they are located on the roof.

Solution 1: Marley dry fix systems

will always be best practice, and the changes to BS 5534 should assist in the continued adoption of dry fix.

For a mortar and maintenance-free mechanical fix, Marley also offers a range of high performance dry fix solutions, including ridge and hip systems meet the requirements of BS 8612 are also able to contribute towards ventilation to meet the requirements of BS 5250.



Solution 2: Mortar bedded security ridge and hip kits

Where mortar bedding is still required, Marley offers mortar bedded security ridge and hip kits. These provide installers with enough mechanical fixings to secure ridge and hip tile fitting directly to the timber framework of the roof. In addition, clips for mechanically fixing small tile cuts at the hip and valley are also available, see opposite.



UNDERLAYS

With lightweight underlays now commonplace, it has been necessary to issue new guidelines to ensure they are securely installed. In contrast to their traditional reinforced bitumen coated predecessors, the new lightweight underlays, if not secured properly, can ‘balloon’ in the roof space, placing a load on the underside of the roof covering, with the potential to dislodge it. BS 5534 compliant mechanical fixing specifications will help eliminate the potential roof damage caused by these issues.

Solution: When installing any underlay, it is important that both manufacturer and British Standard guidelines are followed.

BS 8612 is a British Standard that specifies the performance requirements and methods of testing for a number of dry fixed systems and components, now incorporated into BS 5534.

Marley is widely recognised as one of the early pioneers of the dry fix industry, developing some of the first high-performance, purpose-made systems for pitched roofs.

OFFERING CHOICE WHILST MAINTAINING QUALITY

Whilst many purpose-made systems are still popular today as part of single-source system specifications, there has been an industry-wide move towards complete kit solutions, popular with merchant distributors because of their compatibility with a range of tile and slate types. Marley offers both of these options with our purpose-made and Universal kit ranges.

Exponential growth in the dry fix market – fuelled by recent changes to industry standards and guidelines – has resulted in a huge array of options for specifiers and installers for dry fix products. Consequently, there are now sufficient numbers of competing systems (of varying performance and quality), as to warrant the introduction of a new British Standard, which ensures minimum performance requirements and introduces a recognised standard for the dry fix industry.

BS 8612 KEY FACTORS

This standard sets out the key quality and performance criteria and test methods for dry-fixed roof systems under six essential requirements.

- Material specification and durability
- Mechanical resistance
- Ventilation for ridge and hip systems
- Rain performance
- Geometric characteristics
- Marking, labelling and installation instructions

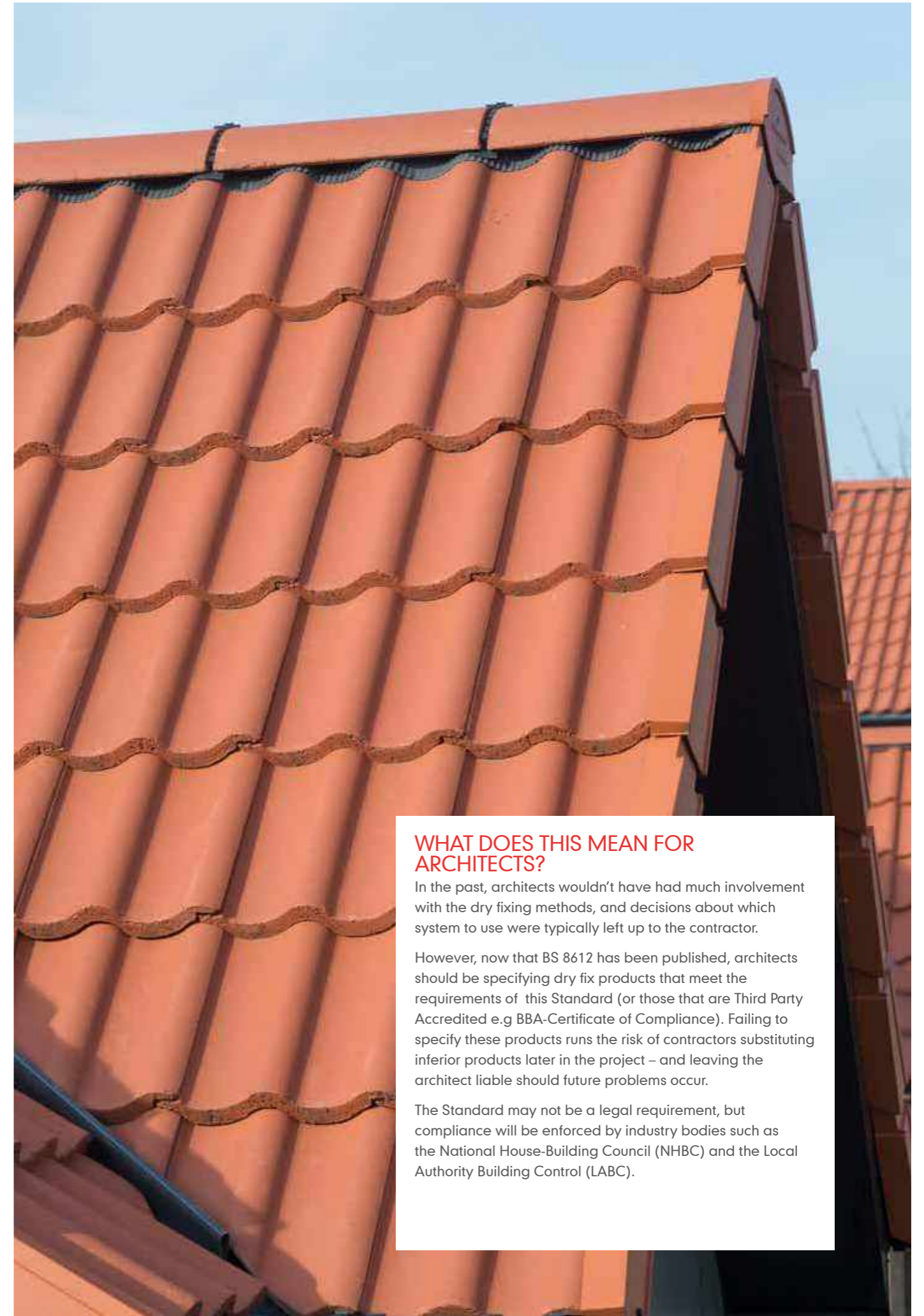

WHAT DOES THIS MEAN FOR ARCHITECTS?

In the past, architects wouldn't have had much involvement with the dry fixing methods, and decisions about which system to use were typically left up to the contractor.

However, now that BS 8612 has been published, architects should be specifying dry fix products that meet the requirements of this Standard (or those that are Third Party Accredited e.g BBA-Certificate of Compliance). Failing to specify these products runs the risk of contractors substituting inferior products later in the project – and leaving the architect liable should future problems occur.

The Standard may not be a legal requirement, but compliance will be enforced by industry bodies such as the National House-Building Council (NHBC) and the Local Authority Building Control (LABC).

STANDARDS AND REGULATIONS

BS 5250



Detailed information on methods to control harmful condensation is given in British Standard BS 5250: 'Code of practice for control of condensation in buildings', Section 8.4 'Roofs'.*

APPROVED DOCUMENT C



Approved Document C 'Site preparation and resistance to contaminants and moisture' contains information relating to 'Roofs (resistance to damage from interstitial condensation)' and 'Roofs (resistance to surface condensation and mould growth)' in Part 6.

APPROVED DOCUMENT F1



The relevant document is Approved Document Part F1 'Means of ventilation'.

Designers should consider the position of terminals to ventilation systems when designing the roof. Approved Document F1 states that there shall be adequate ventilation provided for people in the building. It does not apply to a building or space within a building into which people do not normally go, or which is used solely for storage, or a garage used solely in connection with a single dwelling.

CONTROL OF CONDENSATION

Condensation in roof spaces has become more of a problem with the increase in highly insulated buildings. Moreover, changes in lifestyle have led to higher levels of water vapour in modern buildings. This water vapour naturally ascends to the roof space, where it condenses on contact with cooler surfaces. Further condensation is likely to be caused by climatic conditions, and may eventually result in timber rot, metal corrosion and damage to insulation and fittings.

Approved Document C states: '6.10 A roof will meet the requirements if it is designed and constructed in accordance with clause 8.4 of BS 5250 and BS EN ISO 13788.'

Detailed information on methods to control harmful condensation is given in British Standard BS 5250: 'Code of practice for control of condensation in buildings' Section 8.4 'Roofs'. Prevention of condensation in roof voids is best achieved by the provision of natural air ventilation.

* In course of revision

BS 5250 states that the designer should take account of the following moisture sources in buildings:

- Water incorporated during the construction process (including precipitation);
- Precipitation after construction;
- Water vapour arising from the occupants and their activities;
- Temporary condensation occurring when cold weather conditions are followed by warm, humid weather.

Sealed ceilings

BS 9250 emphasises the importance of well-sealed ceilings as a means to curb the transfer of moisture into a roof space by means of moisture laden air. This means:

- The avoidance of gaps and holes in a ceiling;
- The siting of access doors or hatches into the roofspace away from moisture producing areas such as bathrooms or kitchens;
- That hatch covers must be effectively sealed;
- High levels of workmanship.

Airtightness of ceilings

Air leakage through gaps in a ceiling transfers more heat and moisture into the roof by convection than passes through the ceiling materials by diffusion.

Sealing the ceiling is therefore an essential requirement when considering the design of the roof envelope.

Key design issues to consider are as follows:

- Avoid construction gaps
- Avoid roof access doors or hatches in rooms that produce excessive moisture
- Use a sealed loft hatch and frame to BS EN 13141-1
- Seal all services and rooflights
- Use recessed light fittings rated IP60 to IP65 to BS EN 60529
- Seal the head of cavity walls to prevent transfer of warm moist air into the loft

Underlays

BS 5250 recognises two types of underlay.

- LR underlay: water vapour resistance of $< 0.25\text{MN},\text{s/g}$
- HR underlay: water vapour resistance of $> 0.25\text{MN},\text{s/g}$

When considering the choice of underlay, the designer must consider the system as a whole, including the vapour resistance of other elements such as plywood, chipboard, etc. In addition, the air permeability of the roof covering and the presence of voids within the roof and whether they are connected to the atmosphere, is also important.

Generally speaking, the lower water vapour resistance levels of LR underlays, mean increased capacity to reduce condensation.

The use of a vapour-permeable underlay may also assist in the dispersion of moisture-laden air. However, as this air is discharged into the batten/counterbatten space, it is important that this void is also effectively ventilated.

Some LR underlays are also air permeable, making them capable of allowing air movement from the loft space through the underlay

into the batten space, thereby further reducing the risk of condensation on the underlay and cold structure.

It is recommended that designers should undertake a Condensation Risk Analysis in accordance with BS 5250 to determine the level of ventilation required.

ROOF TYPES

BS 5250 discusses three roof types:

1. ROOFS WITH A LARGE VOID ABOVE INSULATION

Where insulation is at ceiling level and the void is therefore uninhabited and 'cold'.

Here, problems with condensation can be minimised provided that there is adequate provision for ventilation, which BS 5250 specifies as:

- 25mm along the length of the eaves for pitches of 15° or less
- 10mm along the length of the eaves for pitches of more than 15°
- Additional continuous 5mm ventilation at high level for roofs where pitch exceeds 35°, or for roofs of any pitch with a span of more than 10m for lean-to or mono-pitch roofs.

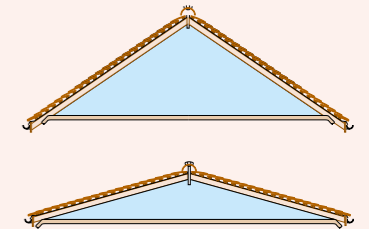

2. ROOFS WITH A SMALL OR NO VOID ABOVE INSULATION

Where the insulation follows the line of the rafters, often creating a habitable space, or 'warm' roof. Problems with condensation can be minimised by elimination of gaps in the insulation and providing a well-sealed ceiling.

BS 5250 specifies adequate provision for ventilation for these types of roof as:

- Low level openings should be equivalent in area to a continuous opening of not less than 25mm along the length of all the eaves.
- High level openings should be equivalent to a continuous opening of not less than 5mm along the length of the ridge or hip.

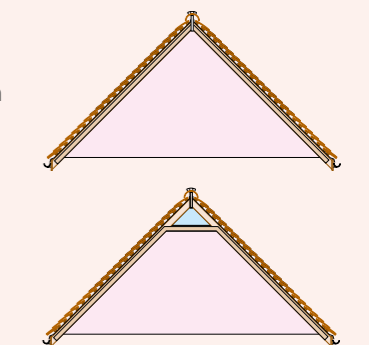

3. TILED AND SLATED ROOFS CONTAINING ROOMS (HYBRID)

These should be ventilated as 2, above, but if an obstruction to a ventilation path occurs, such as fire separating walls, additional ventilation openings should be provided.

- Immediately below the obstruction equivalent to 5mm along the length of the obstruction.
- Immediately above the obstruction equivalent to 25mm along the length of the obstruction.

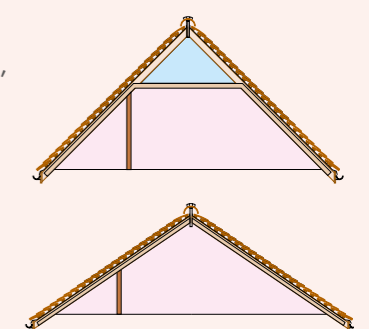

Notes on roof types 1, 2 and 3 for 'cold' and 'warm' roofs

- If it is not possible to use ridge ventilators or eaves ventilators because of the detailing of the roof, in-line ventilators should be used.
- The clear ventilation path from the interior of the roof to the exterior must always be designed so that it does not compromise the weatherproof function of either the underlay or the roof covering.
- All ventilation openings should be fitted with a screen or grille to help prevent the ingress of rain, snow, birds and large insects, but the holes in the grille should be not less than 4mm in diameter to prevent excessive airflow resistance.

In a 'cold roof', the most common form of roof construction, the insulation is laid at ceiling joist level, leaving the roof space relatively colder than the accommodation below.

To comply with Approved Document C and BS 5250, free airspace should be provided at both eaves and/or ridge level to ensure that effective through-ventilation of the whole roof is achieved, and thereby to assist in the control of condensation.

The following illustrations suggest the correct positioning of vents and the precise amount of free airspace required for four types of 'cold roof' construction in accordance with Approved Document C and BS 5250. These recommendations apply if an HR underlay is used.

NORMAL CEILING

A ceiling where no attempt has been made to seal all gaps or penetrations (e.g. light drops, pipes etc.)

WELL-SEALED CEILING

The design avoids construction gaps, especially at the wall ceiling junction with dry lining construction and holes in the ceiling.



No access door or hatch should be located in rooms where large amounts of moisture are produced, including kitchens or bathrooms.

The ceiling is sealed to the external walls to limit any leakage through cracks. The head of all cavities in the external walls, party walls and partition walls are sealed to prevent transfer of warm, moist air into the loft.

Further information on the construction of 'well sealed' and airtight ceilings can be obtained in BS 9250.

VENTILATION OPTIONS

Key to illustrations

-  Warm roof/ building areas
-  Cold roof/ building areas
-  Low Resistance underlay
-  High Resistance underlay
-  Sarking

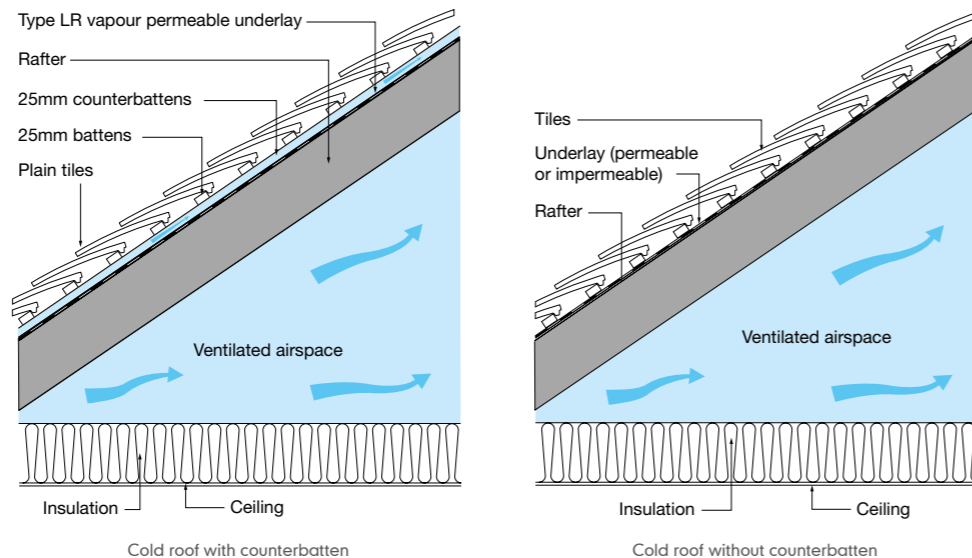

CLOSE-FITTING COVERINGS

When specifying a close-fitting covering which is relatively airtight (such as fibre cement slates with an LR underlay), there is a risk of interstitial condensation forming on the underside of the underlay and the external covering.

To avoid this risk, the batten space should be ventilated in accordance with BS 5250 using counterbattens.

FULLY BREATHABLE UNDERLAYS

The British Standard mainly distinguishes between two types of underlay: high resistance (HR) impermeable and low resistance (LR) vapour permeable. However, there are some manufacturers of low resistance underlays that claim their products are fully air breathable, negating the requirement for ventilation as set out in the British Standard.

There are a number of factors to consider before using any type of low resistance underlay, including:

1. How well the ceiling is sealed
2. Whether a close-fitting roof covering is being used
3. Obstructions in the roof space

In all circumstances, Marley recommend the use of additional ventilation when using any type of low resistance underlay.

This can be achieved through the use of ventilated eaves and ventilated ridge systems or in-line ventilators.

ROOFS WITH A 'NORMAL' CEILING

Re-reinforced bituminous underlays and vapour impermeable underlays (high resistance HR)

Ventilation of the loft space under a traditional reinforced bituminous underlay or non-vapour permeable underlay has proven to be an effective and robust solution when used with suitable high and low level ventilation.

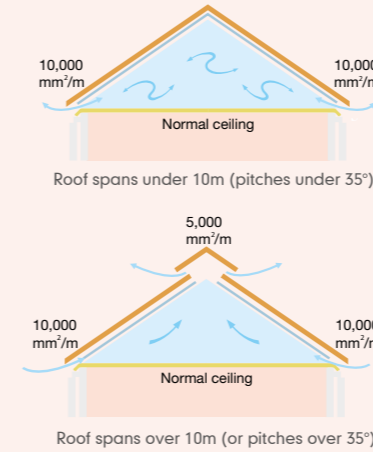

Vapour permeable underlays (low resistance LR)

A low resistance underlay can reduce the requirement for ventilating the roof space. On fully boarded roofs, i.e. sarking, low resistance underlays should be treated as impermeable and the roof space below will need to be ventilated in accordance with the high resistance underlay requirements described above.

Where a close-fitting roof covering has been used, the batten spacing should be ventilated in accordance with BS 5250 and by creating a void using counterbattens.

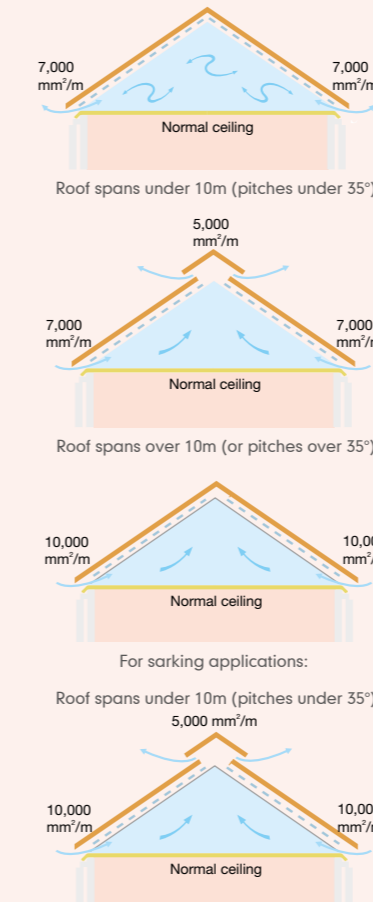

ROOFS WITH A 'WELL-SEALED' CEILING

Bituminous felts and vapour impermeable underlays (high resistance)

The ventilation requirements for cold roofs with vapour impermeable underlays and 'well-sealed ceilings' are the same as for those without. Installing a 'well-sealed ceiling' will make the roof more energy efficient because airtightness will have prevented heat loss through convection. Heat loss due to low speed air currents over the cold side of the insulation (caused by ventilation) is negligible.

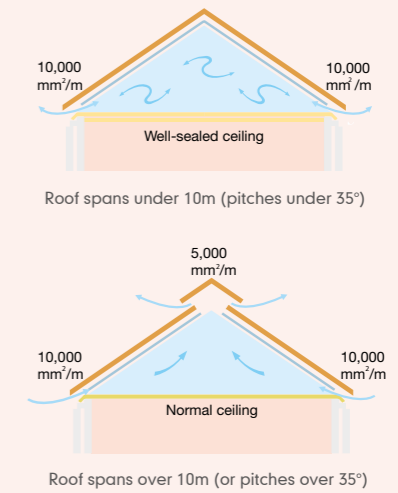

Vapour permeable underlays (low resistance)

The installation and maintenance of a 'well-sealed ceiling' with a vapour permeable underlay can reduce the ventilation requirements.

However, where a close-fitting roof covering is used, the batten space should be ventilated in accordance with BS 5250 using counterbattens.

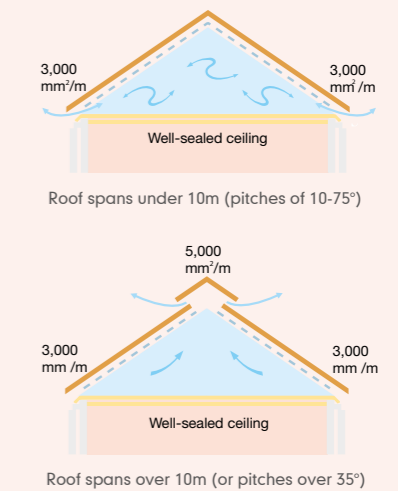

In a 'warm roof', the insulation can be laid above, between or below rafter level, or in a combination of all these positions. This form of construction is generally chosen when the roof space is to be used for habitation.

Even though there is less risk of condensation with 'warm roof' construction, it is practically impossible to seal all joints, gaps and penetrations against all water vapour transmission, and it is therefore recommended that 'warm' roofs be ventilated at high and low level to comply with Approved Document C and BS 5250.





The following illustrations suggest the correct positioning of vents and the precise amount of free airspace required for three types of 'warm roof' construction in accordance with BS 5250.

WARM PITCHED ROOF WITH HR UNDERLAY

In roofs with an HR underlay, whatever form of external covering or ceiling is provided, there is a risk of interstitial condensation forming on the underside of the HR underlay. To avoid that risk, an AVCL (air vapour control layer) should be provided on the warm side of the insulation and ventilated voids should be formed between the underside of the underlay and the insulation. Each void should be at least 25mm deep and vented at both high and low level.

VENTILATION OPTIONS

Key to illustrations

-  Warm roof/ building areas
-  Cold roof/ building areas
-  Low Resistance underlay
-  High Resistance underlay
-  Sarking

Small void above insulation and a type HR underlay

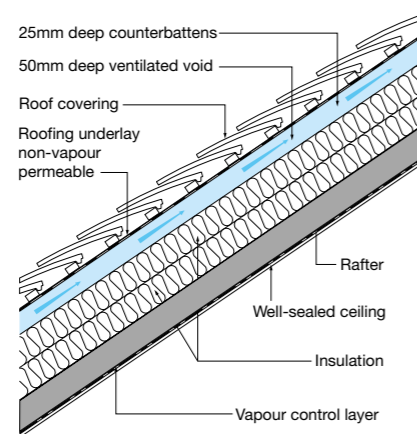

No void above insulation and a type LR underlay

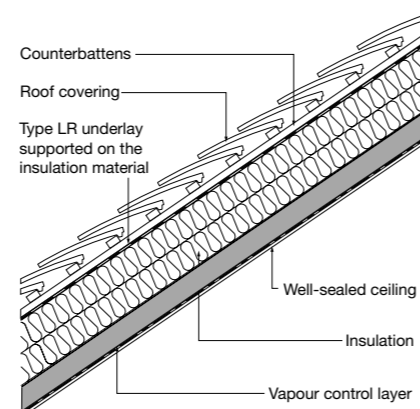

WARM PITCHED ROOF WITH LR UNDERLAY

In warm pitched roofs with LR underlay, an AVCL should be provided at the ceiling line.

If the external covering is sufficiently permeable, it will allow vapour to be released and no ventilation of the batten space is recommended.

If it is not practicable to provide an AVCL, there might be some risk of interstitial condensation forming on the underside of the underlay. To avoid the risk, ventilated voids should be provided.

CLOSE-FITTING COVERINGS

When specifying a close-fitting covering which is relatively airtight (such as fibre cement slates with an LR underlay), there is a risk of interstitial condensation forming on the underside of the underlay and the external covering.

To avoid this risk, the batten space should be ventilated in accordance with BS 5250 using counterbattens.

FULLY BREATHABLE UNDERLAYS

BS 5250 mainly distinguishes between two types of underlay: high resistance (HR) impermeable and low resistance (LR) vapour permeable. However, there are some manufacturers of low resistance underlays that claim their products are fully breathable, negating the requirement for ventilation as set out in the British Standard.

There are a number of factors to consider before using any type of low resistance underlay, including:

1. How well the ceiling is sealed
2. Whether a close-fitting roof covering is being used
3. Obstructions in the roof space

In all circumstances, Marley recommend the use of additional ventilation when using any type of low resistance underlay.

This can be achieved through the use of ventilated eaves and ventilated ridge systems or in-line ventilators.

ROOFS WITH AN AVCL

Reinforced bituminous felts and vapour impermeable underlays (high resistance HR - for example Marley's non-breathable underlay)

The ventilation requirements for cold roofs with vapour impermeable underlays and 'well-sealed ceilings' are the same as those without. Installing a 'well-sealed ceiling' will make the roof more energy efficient because airtightness will have prevented heat loss through convection. Heat loss due to low speed air currents over the cold side of the insulation (caused by ventilation) is negligible.

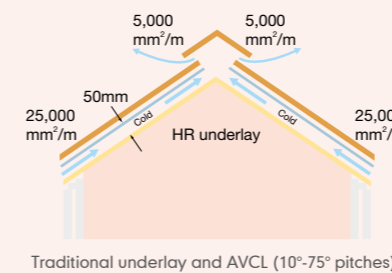

ROOFS WITH A CLOSE-FITTING ROOF COVERING

For warm roofs with a close-fitting roof covering, ventilation will be required either above or below the underlay, dependent on the underlay type.

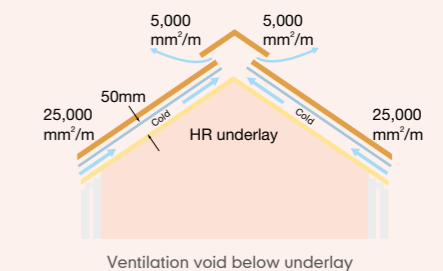
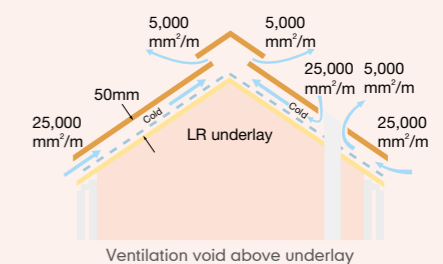

Vapour permeable underlays (low resistance LR)

Where an AVCL has been installed, the harmful effects caused by condensation can be controlled by the use of a vapour permeable underlay without ventilation. The vapour permeable underlay may be laid fully supported on the insulation or draped unsupported.

An AVCL is essential on the warm side of the insulation. If there is any doubt about the ability to provide and maintain an effectively sealed AVCL, and the roof covering is not air permeable, then ventilation should be provided as if the underlay were impermeable.

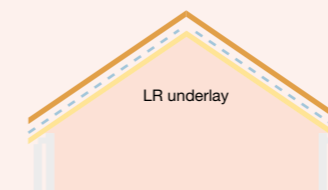

STANDARDS AND REGULATIONS

APPROVED DOCUMENT C

Clause C2 of Approved Document C states that the roof of the building shall adequately protect the building and people who use the building from harmful effects caused by precipitation and wind-driven spray.

Roofs are required to resist the penetration of precipitation (rainfall) to the inside of the building, thereby preventing damage to any part of the building where it might be carried.

Most pitched roofs keep the rain and snow out of the building and give satisfactory performance. However, it is acknowledged that similar roofs built to the same design and using identical roof materials, but in different locations, may not necessarily provide the same level of assurance, since they will be subject to different weather conditions and exposure.

EXPOSURE TO DRIVING RAIN

The UK has a high risk of severe driving rain, and even in some sheltered locations, may be subject to high levels of deluge rainfall.

BS 5534 defines two categories of exposure, based on the driving rain data given in BS 8104 and BR 262 and should be used for buildings up to 12m in height (see map opposite). For buildings over 12m in height, the influence of increased wind speeds should be taken into account using BS EN 1991-1-4. Guidance on the use of Marley tiles and slates on roofs greater than 12m in height should be obtained from the Technical Advisory Service.

PERFORMANCE OF TILES

Rain penetration of the roof covering is dependent on a combination of the rainfall rate, wind speed, and the ability of the roof tile to resist the ingress of snow and rainwater.

The designer should therefore be aware of the various means by which rain and snow can, under certain conditions, penetrate the roof covering. These include:

- capillary action and rainwater creep
- raindrop bounce and negative pressure rain suction
- driving rain, deluge rain and flooding
- surcharging of rainwater at overlaps of tiles on long rafter length roofs
- wind-driven snow.

ROOF PITCH

When determining the pitch, headlap and/or sidelap of a tile, the roof pitch is taken to be equal to the rafter pitch. Hence, all references to pitch refer to the rafter pitch, with the laid angle of the roof tile always being less than roof pitch.

The actual pitch of a tile should be determined in accordance with the following guidelines:

Tile/slate to rafter pitch angles

- Plain tiles: 7° less than rafter pitch
- Interlocking single lap tiles: 5° less than rafter pitch

Marley plain tiles, and interlocking tiles are designed and tested to minimum rafter pitches

If the design rafter pitch is less than the minimum recommended rafter pitch for the particular tile, a build up of surface water may cause the product to leak., and it can only then be considered to have an aesthetic function.

In such cases, the true weatherproofing of the roof system must rely on a fully supported waterproof membrane with an uninterrupted drainage path between counterbattens to the eaves gutter. Details of the full specification for such a roof construction can be obtained from the Technical Advisory Service.

HEAD AND SIDE LAPS

All products are subject to the following recommended minimum laps:

Headlap

Double lap tiles: The headlap for double lap products is taken as the distance by which the upper course of the tile provides a lap with the next but one course below.

Plain tiles: For Marley double lap concrete and clay plain tiles, the headlap should be not less than 65mm and should not exceed one-third of the length of the tile.

Double lap concrete plain tiles have a negative longitudinal camber, which prevents capillary action and can be used satisfactorily at a minimum roof pitch of 35°.

Double lap clay plain tiles are produced in a range of both machine and handmade designs, and can be used at roof pitches from 30° (Acme Single Camber) to 40° (Canterbury Hand Made).

When determining the head lap of feature and ornamental double-lap tiles, the shape of the tail should be taken into account.

Single lap tiles or slates: For single lap tiles, the headlap is the distance by which a course of tiles provides an overlap with the next course below. In the case of Marley interlocking single lap tiles, a minimum overlap of 75mm is sufficient for most roof pitches of 30° and above. Below 30°, the overlap may be increased to 100mm to cater for different surface finishes (smooth, granular or sanded).

Sidelap

Double lap tiles: For plain tiles, the notional sidelap is the side distance by which the tile overlaps the tile in the next course below.

Single lap tiles: For interlocking tiles, the sidelap is accommodated by an interlocking channel design feature incorporated into the side edges of the tile.



Plain tiles: For plain tiles, the side lap should be not less than one-third the width of the tile and using Marley plain tiles at 100mm gauge, the side lap should be not less than 55mm for clay plain tiles and 56mm for concrete plain tiles.

Single lap tiles: The side lap for Marley single lap products is the amount by which one tile overlaps the adjacent tile in the same course by way of a side interlock or upstand feature which forms part of a proprietary side-lock design.

PERFORMANCE TESTING

All Marley tiles, fittings and accessories are designed and tested in a purpose-built wind and rain tunnel, using a test method in accordance with the requirements of PD CEN/TR 15601 'Hygrothermal performance of buildings - Resistance to wind-driven rain of roof coverings with discontinuously laid small elements - Test methods. to function effectively at specified minimum roof pitches and laps in all areas of exposure, subject to the above limitations..

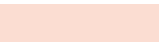
CATEGORIES OF EXPOSURE TO DRIVING RAIN*

Exposure zones	Approximate volume of wind-driven rain (litres/m ² per spell)
	<33 (Sheltered exposure)*
	≥33 <56.5 (Moderate exposure)*
	≥56.5 <100 (Severe exposure)*
	100 (Very Severe exposure)*

* Categories derived from BS 8104 and BRE 262

Further guidance on categories of exposure to driving rain can be obtained from BS 8104 'Code of practice for assessing exposure of walls to wind-driven rain' and BRE Report 262 'Thermal insulation: avoiding risks'.

The effectiveness of the tile or slate to operate at the minimum recommended pitch and lap may be influenced by special circumstances. Guidance on pitch and lap should be obtained from the Technical Advisory Service for the following:

- Interlocking tiles and slates where the roof slope exceeds 6 metres in length and/or the site is rated to be in a severe exposure category.

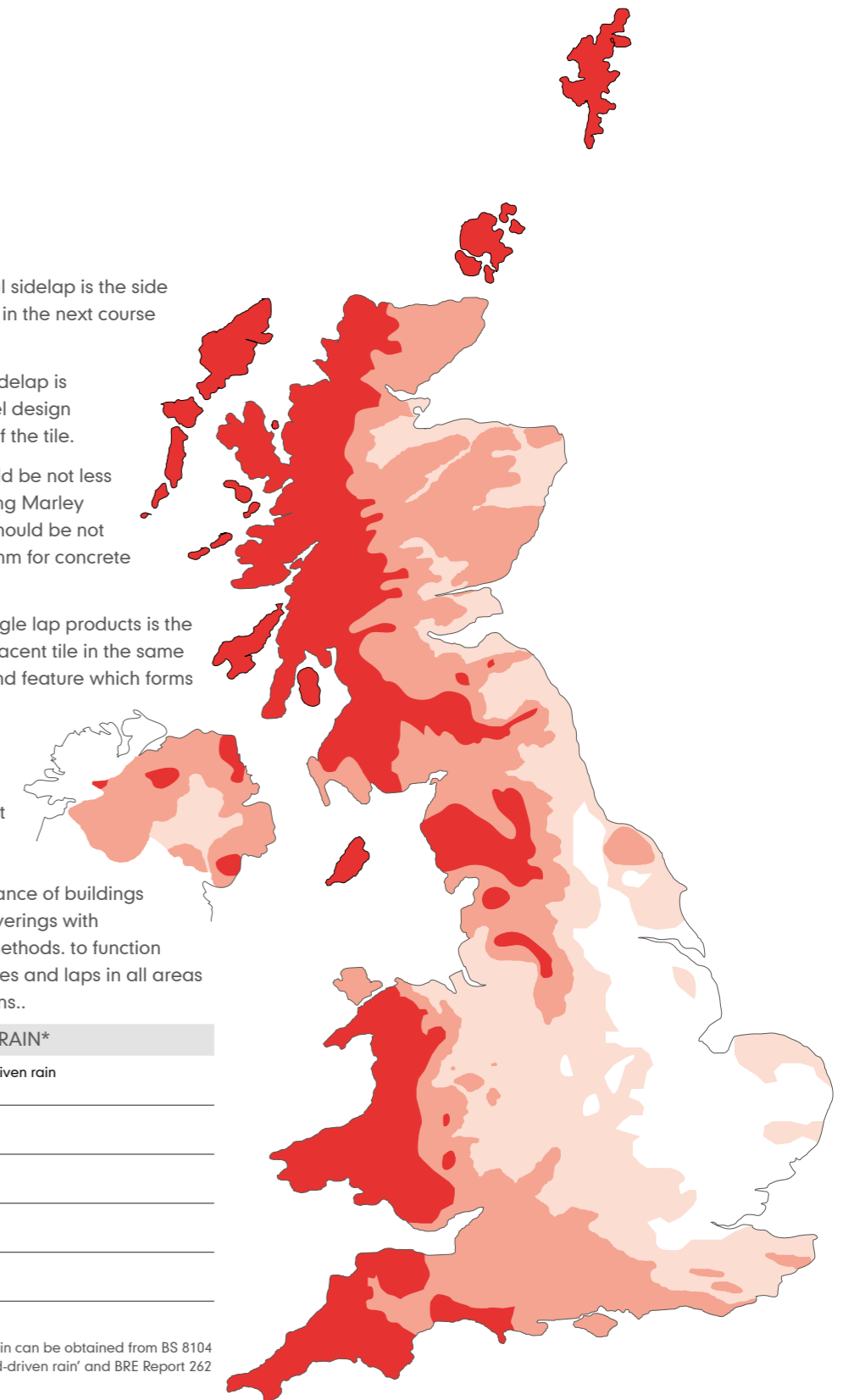

WEATHER RESISTANCE

WIND

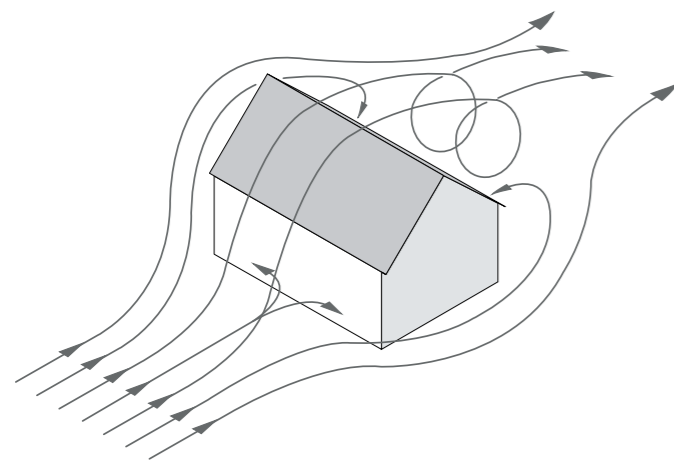

Reaction of wind flow to obstruction

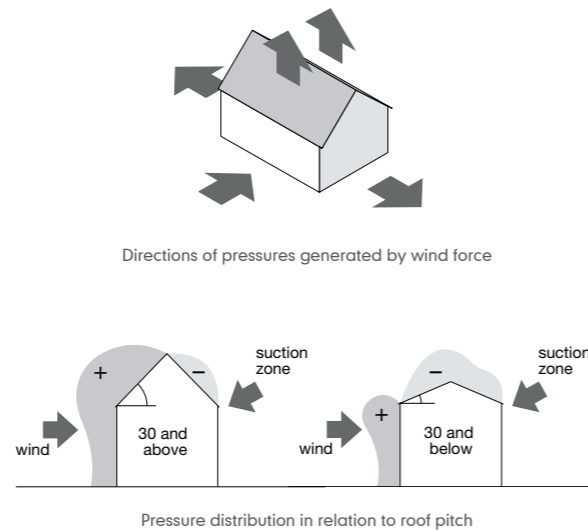

Pressure distribution in relation to roof pitch

WIND FORCES ON BUILDINGS

Each year, as many as 200,000 buildings in the UK may be damaged by gales. Roof damage represents by far the largest sector of the total number of building elements affected.

Wind can affect a building and its roof in a pattern determined not only by climate and topography, but also by wind direction, the shape of the building and the pitch of the roof.

Wind blowing at 90° to a building is slowed down when it hits the surface of the building, with a consequent build up of pressure. At the same time, it is deflected around the end walls and over the roof, creating areas of negative pressure or suction. The stronger the wind, the greater the suction.

The force of the wind acting on the windward slope of a roof is determined by roof pitch. Research has shown that, where the pitch is less than 30°, the windward slope can be subjected to severe suction or negative pressure. A roof with a pitch greater than 35° generally presents sufficient obstruction to the wind to create a positive pressure on the windward face, although, even here, there is an area close to the ridge where suction develops. Leeward slopes are always subject to suction.

During strong wind gusts, the uplift pressure on the roof tiles or slates caused by the suction load may be in excess of their dead weight, thereby requiring them to be securely fixed by mechanical fixings (nails, clips, hooks or screws) to prevent them from being lifted from the roof.

In addition, if there is a risk of differential movement between the roof structure and adjacent rigid masonry support, fittings such as ridge, hip and verge tiles will require mechanical fixing, since no reliance can be placed on the tensile strength of bedding mortar.

DESIGN FOR WIND LOADING

When considering the wind loading on the roof covering, designers should consult BS 5534. This provides calculation methods to assess the wind load on each tile or slate as a uniformly distributed load, and also takes into account the porosity of the tiles or slates and the effectiveness of the substrate (boarding or sarking), and/or underlay shielding, when calculating wind uplift loads.

The standard method in BS EN 1991-1-4 Eurocode 1 'Actions on structures. General Actions. Wind Actions' should be used to determine the basic wind speed of the site, which is then used to calculate the effective wind speed and dynamic wind pressure on the roof, by applying a series of factors to account for terrain, topography, building height and length etc.

CONTROL OF INTERNAL PRESSURE

The total wind force on a roof is dependent on the pressure differential between the inner and outer faces of the roof covering.

Such pressures are significantly reduced by the use of underlay or boarding beneath tiling or slating. Its contribution towards shielding the underside of the tiles or slates from the full transmission of internal pressures, places a requirement for the underlay to have an adequate tensile strength for the specific application.

The tensile strength of the underlay, its air permeability factor and withdrawal resistance of batten nail fixings, is therefore important when determining the overall resistance to wind uplift of the roof system. Refer to BS 5534.

RIDGES AND HIPS

Any tensile strength offered by the mortar bedding of the concrete or clay ridge/hip tiles should not be taken into account. Therefore, in all cases, ridge or hip tiles should be mechanically fixed to resist the calculated wind uplift force.

Marley dry fix ridge and hip systems provide full mechanical fixing of all ridge and hip tiles to meet BS 5534 recommendations.

In all cases, ridge or hip tiles should be mechanically fixed to resist the calculated wind uplift force.

AIRCRAFT VORTICES

Roofs near airports can experience high local wind load forces due to air vortices created by modern large aircraft when taking off and landing, which may be greater than the calculated wind loads to BS 5534. Designers should seek advice from the Airport Authority Planning Department when designing roof fixings in these locations, and refer to the guidance contained in BRE Digest 467 'Slate and tile roofs: avoiding damage from aircraft wake vortices'.

CALCULATING THE FIXING SPECIFICATION

The procedures for calculating the wind loads and determining the fixing specification for tiles in accordance with BS EN 1991-1-4 and BS 5534 are complex to undertake.

Designers are advised to obtain a full roofing fixing specification from the Technical Advisory Service. For further details and information on Fixing Spec, see page 121.

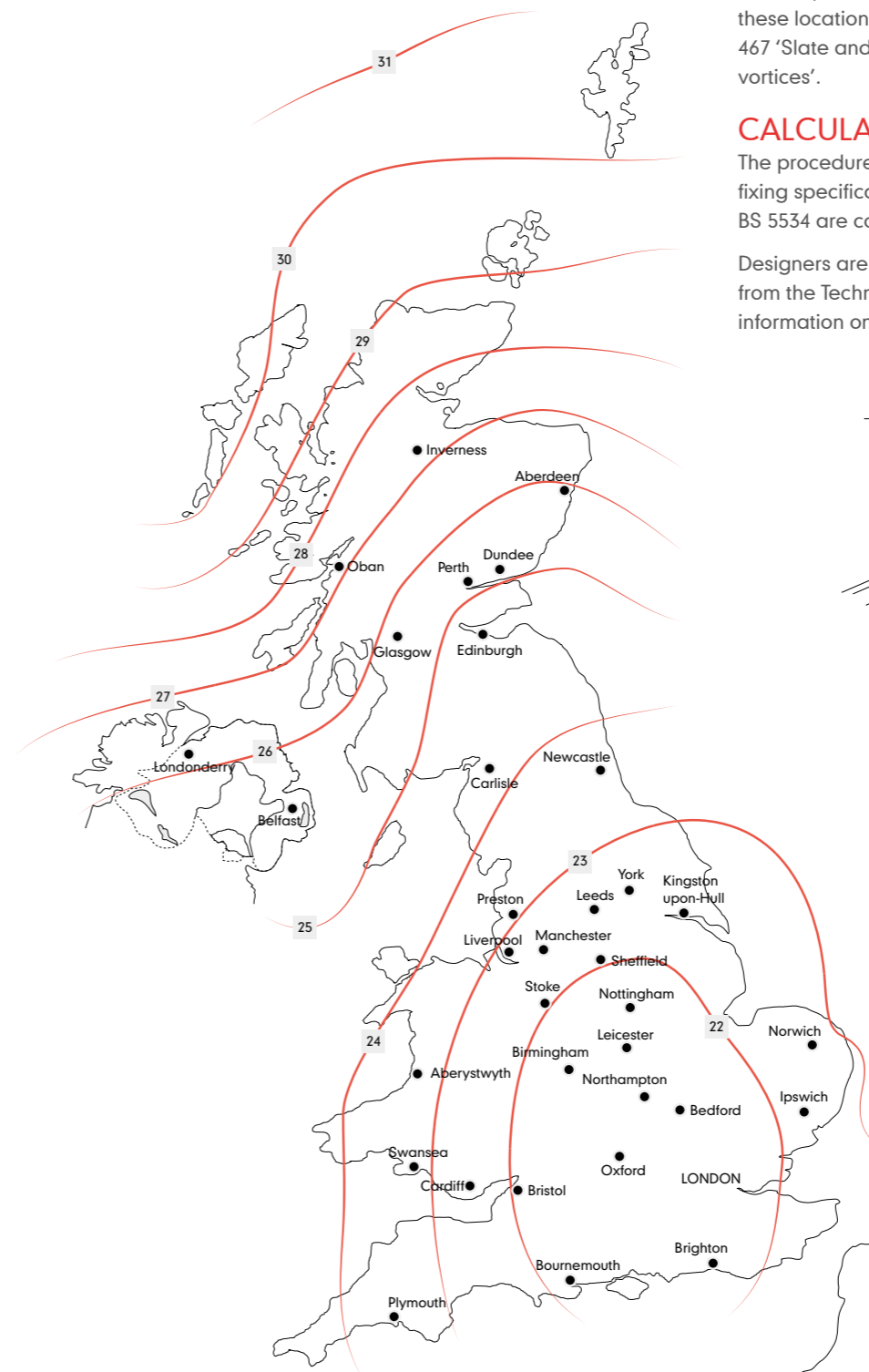

BASIC WIND SPEED*

— 31 — Basic wind speed V_b (in m/s)

Note: Channel Islands basic wind speed = 24 m/s
* Derived from BS 6399-2

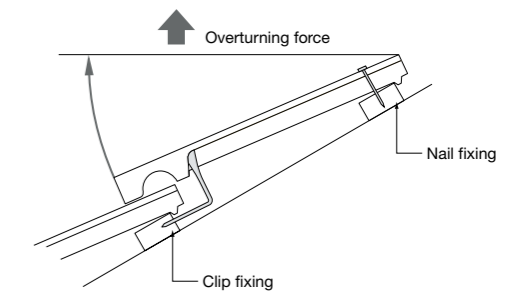

Restraining an interlocking tile against wind uplift

STANDARDS AND REGULATIONS

APPROVED DOCUMENT L



The relevant documents are Approved Document L1A 'Conservation of fuel and power in new dwellings'; L1B 'Conservation of fuel and power in existing dwellings'; L2A 'Conservation of fuel and power in new buildings other than dwellings' and L2B 'Conservation of fuel and power in existing buildings other than dwellings' for England and Wales and Section 6 'Energy' (domestic and non-domestic) for Scotland.

For Wales it is Approved Document L1A 'Conservation of fuel and power – new dwellings'; L1B 'Conservation of fuel and power – existing dwellings'; L2A 'Conservation of fuel and power – new buildings other than dwellings' and L2B 'Conservation of fuel and power – existing buildings other than dwellings'.

For Northern Ireland it is Technical Booklet F1 – 'Conservation of fuel and power in dwellings' and Technical Booklet F2 – 'Conservation of fuel and power in buildings other than dwellings'.

The Building Regulations prescribe high standards of building fabric insulation for floors, walls and roofs as well as space heating, lighting, and hot water controls so as to limit the heat loss from the building.

* In course of revision

COMPLIANCE

The new requirements of the Regulations are designed to reduce carbon emissions from new buildings and to improve the performance of existing buildings where new work is carried out.

Parts L1A, L1B, L2A and L2B have a single method of compliance. This is expressed in CO₂ emissions in kg/m²/year and is calculated by the SAP (Standard Assessment Procedure) 2012 method for dwellings and the iSBEM model for non-dwellings. This is normally undertaken by a specialist consultant.

In terms of the roof, designers will no longer be able to specify 'roofs to comply with Part L' on drawings or in specifications. Products can no longer be labelled 'Part L compliant', as no one element or product can meet Part L without consideration for all other elements in the construction and energy use of the building.

The design process is now more complicated as a number of assumptions have to be made at the design stage when inputting data into the SAP or SBEM calculations before the specification can be finalised.

Under the current regulations, the main areas for construction are:

- External envelope U-values for walls, roofs and floors
- Thermal bridging details
- Ventilation strategy for ensuring fresh air
- Airtightness

REGULATION 43 – AIR PERMEABILITY

Part L 2013 provides requirements for buildings to be tested for air leakage once completed. Testing is carried out using pressurised fans by consultants.

DESIGN CONSIDERATIONS

In order to improve the quality of design details, a set of 'Accredited Construction Details' have been published to accompany Part L.

Attention is given to the provision of suitable insulation to prevent heat loss and cold bridges in roof construction. Guidance measures to prevent moisture ingress, condensation and air leakage are incorporated into the construction details for walls, floors and roofs, with particular attention being given to the junctions of walls to floors and walls to roofs.

As insulation levels increase so does the potential risk of condensation, and so designers should consider the recommendations with regard to the prevention of condensation in 'cold' roof voids contained in BS 5250: 2011.



WARM ROOF EAVES DETAIL TO MEET PART L

- If required by BS 5250, use a vapour control plasterboard or a separate air and vapour control layer (AVCL) behind the plasterboard.
- Use a proprietary eaves ventilator to ensure ventilation in accordance with BS 5250.
- The use of over joist and under rafter insulation is considered best practice as it eliminates the cold bridge caused by the joist/rafter.
- The installation of the eaves ventilator must not prevent free water drainage below the tiling battens.

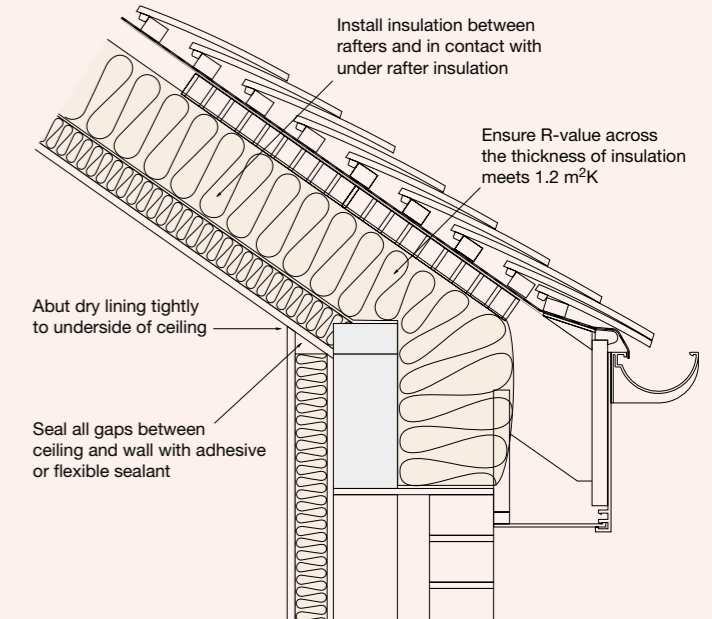

COLD ROOF EAVES DETAIL TO MEET PART L

- Ensure that cavities are kept clean of mortar snots or other debris during construction.
- The use of over joist insulation is considered best practice as it eliminates the cold bridge caused by the joist.
- Use a proprietary eaves ventilator to ensure ventilation in accordance with BS 5250.
- The installation of the eaves ventilator must not prevent free water drainage below the tiling battens.

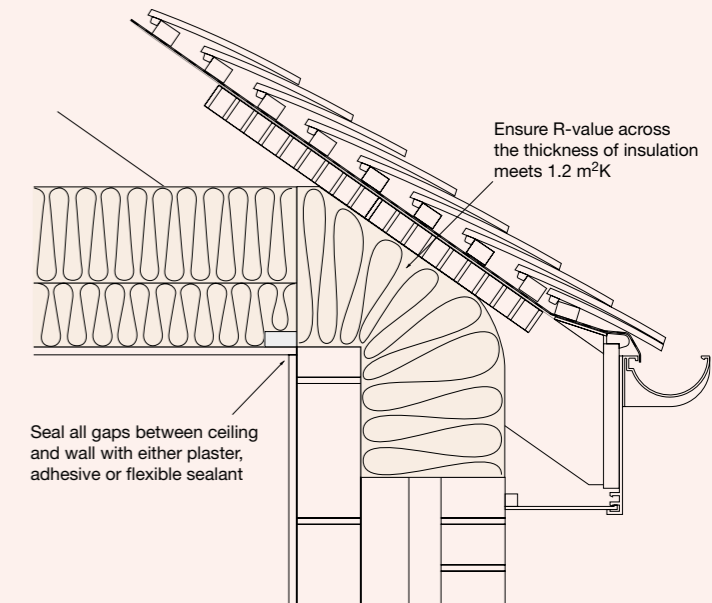

OTHER REGULATIONS AND STANDARDS

The following Building Regulations may also have an influence on the design and/or construction of pitched roofs. More information on these Approved Documents can be found at: www.planningportal.gov.uk/buildingregulations

STRUCTURE

- England: Part A 'Structure'
- Wales Part A : Structural safety
- Scotland: Technical handbook, Section 1 'Structure'
- Northern Ireland: Part D 'Structure'

SOUND

- England: Part E 'Resistance to the Passage of Sound'
- Wales : Part E : 'Resistance to the Passage of Sound'
- Scotland: Technical handbook, Section 5 'Noise'
- Northern Ireland: Part G 'Sound Insulation of Dwellings'

DRAINAGE

- England: Part H 'Drainage and Waste Disposal'
- Wales: Part H : 'Drainage and Waste Disposal'
- Scotland: Technical handbook, Section 3 'Environment'
- Northern Ireland: Part N 'Drainage'

CHIMNEYS/FLUES

- England: Part J 'Heat producing appliances'
- Wales: 'Heat producing appliances'
- Scotland: Technical handbook, Section 3 'Environment' Section 4 'Safety'
- Northern Ireland: Part L 'Heat producing appliances and liquefied petroleum gas installations'



OTHER PARTS OF THE UK



Wales

Since 31 December 2011, the Welsh Assembly has had responsibility for setting Building Regulations in Wales. Separate Approved Documents are produced for Wales, which in most cases are similar to England, but there are differences which need to be identified by reference to the Welsh versions.



Scotland

'Technical Handbooks' provide guidance on achieving the standards set in the Building (Scotland) Regulations 2013 and are available in two volumes, Domestic buildings and Non-domestic buildings.



Northern Ireland

The Northern Ireland Building Regulations are legal requirements made by the Department of Finance and Personnel and administered by 26 District Councils. The Regulations are intended to ensure the safety, health, welfare and convenience of people in and around buildings. They are also designed to further the conservation of fuel and energy.

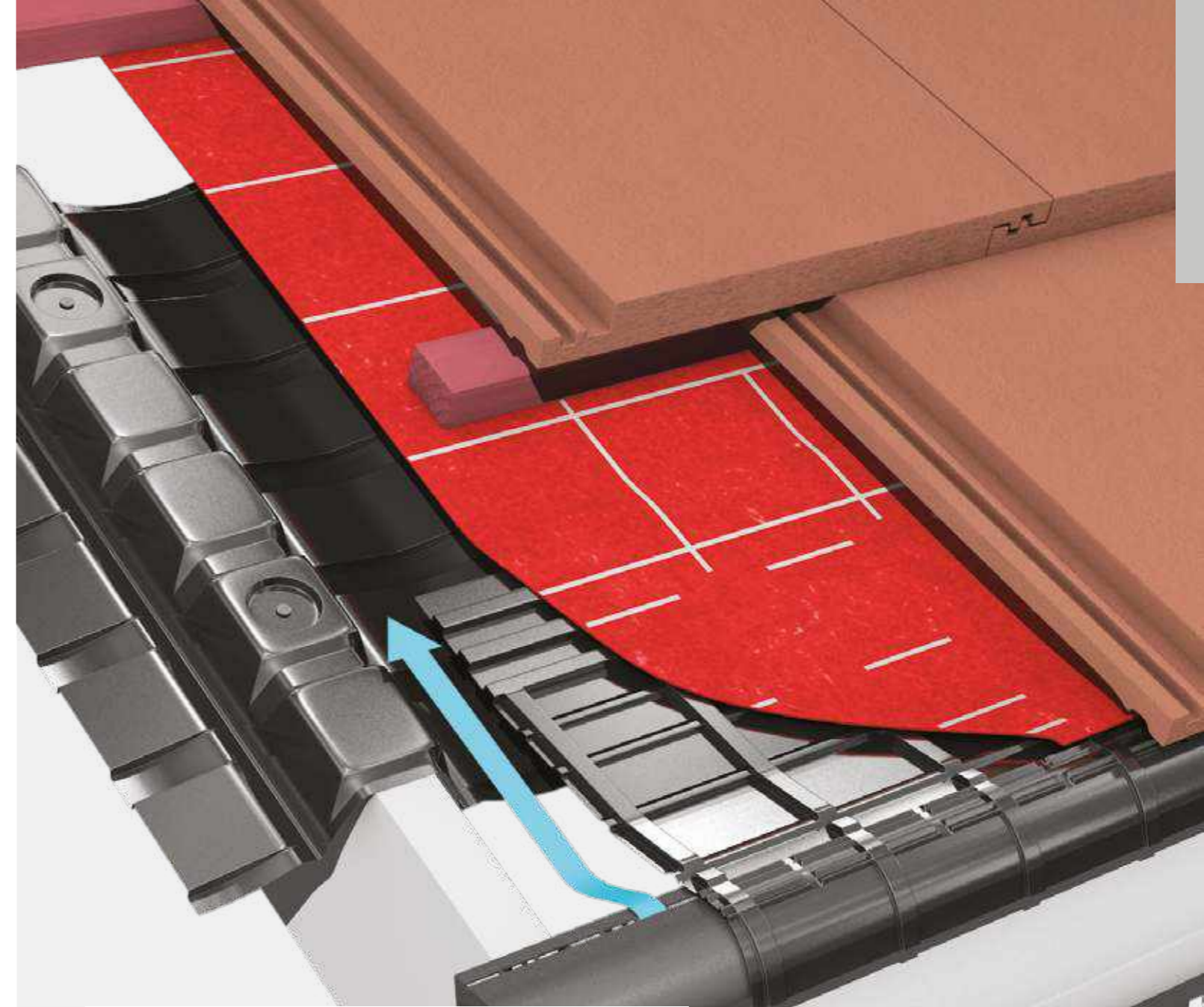

Eaves

The eave is the lowest part of any roof and has two key functions: it protects the walls of the building from rain and sun, and collects the rainwater run-off from the roof to discharge it to the gutter. The eaves is also the location for roof ventilation components, which are used to direct air over the wall plate and insulation and into the roof or batten space.

The eaves may be formed using a boxed soffit with fascia and soffit boards fixed to the end of the rafters; an open eaves or rafter which exposes the rafters overhanging the wall plate or a closed eaves which has a fascia board, or tilting fillet fixed to the external wall.

SELECTED EAVES DETAILS

UNIVERSAL EAVES VENT SYSTEMS

The Universal eaves ventilation systems shown on pages 142-145 are suitable for all tiles and slates. Vapour permeable underlay shown.

- ▲ eaves ventilation to satisfy 10mm or 25mm conditions
- ▲ eaves to ridge ventilation for pitches of 12.5°- 55°
- ▲ for use with vapour permeable or non-breathable underlays
- ▲ continuous rafter roll allows free air passage.
- ▲ strip ventilator has discreet ventilation grille and is nailed to fascia or timber fillet
- ▲ suitable with or without soffit board
- ▲ use comb filler strip with deep profiled tiles
- ▲ mechanically fix all tiles at eaves

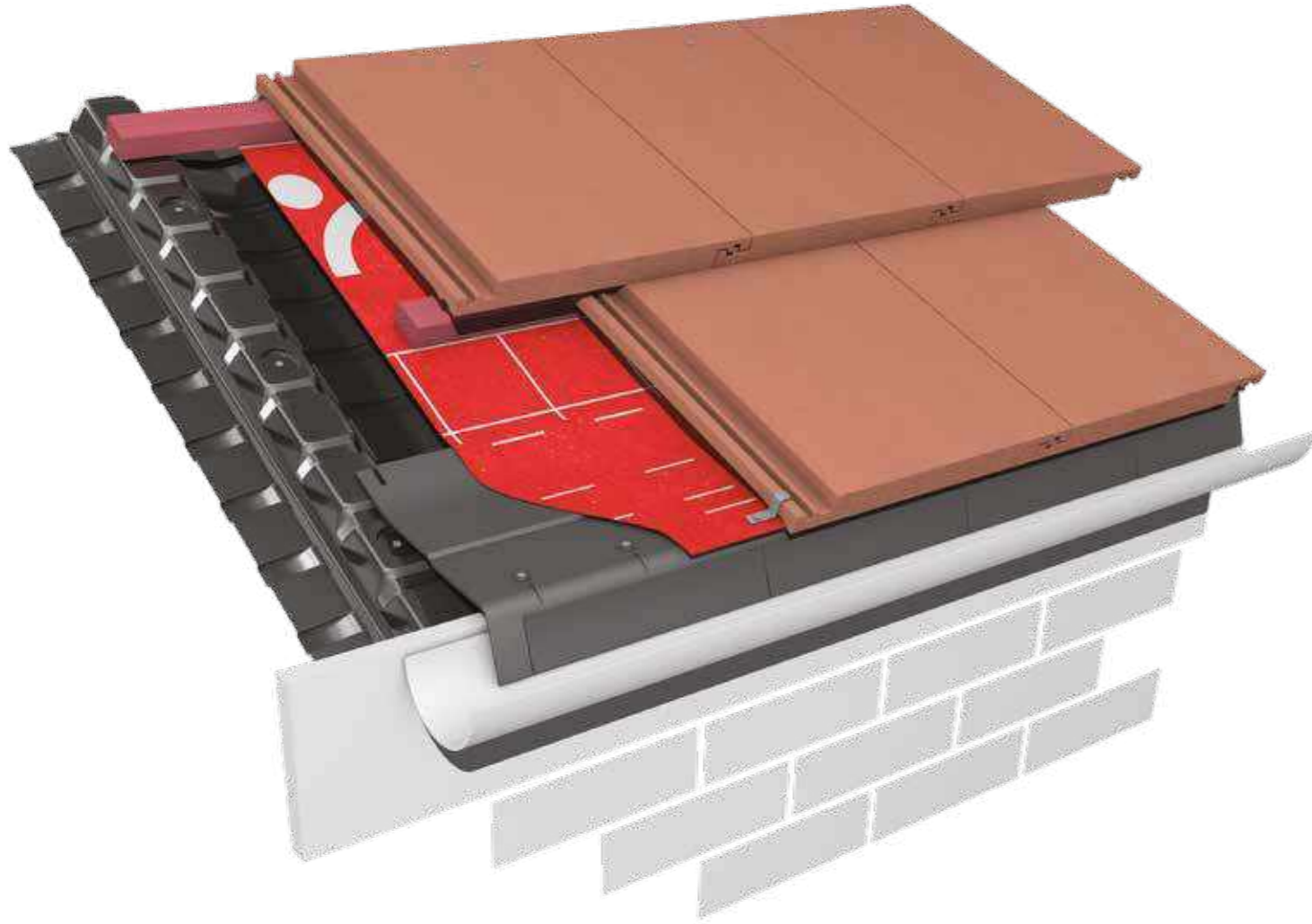

UNIVERSAL 10MM EAVES VENT SYSTEM

- ▲ cold roof with vapour permeable underlay shown

UNIVERSAL 10MM EAVES VENT SYSTEM WITH INTERLOCKING TILES

- ▲ cold roof with vapour permeable underlay shown

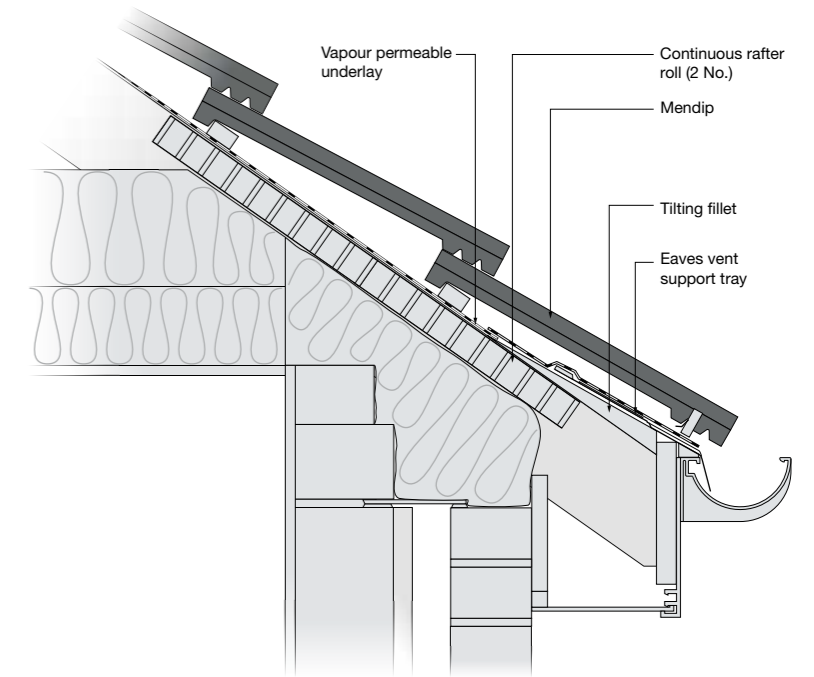

UNIVERSAL 25MM EAVES VENT SYSTEM WITH EDGEMERE INTERLOCKING SLATES

- ▲ warm roof with vapour permeable underlay shown

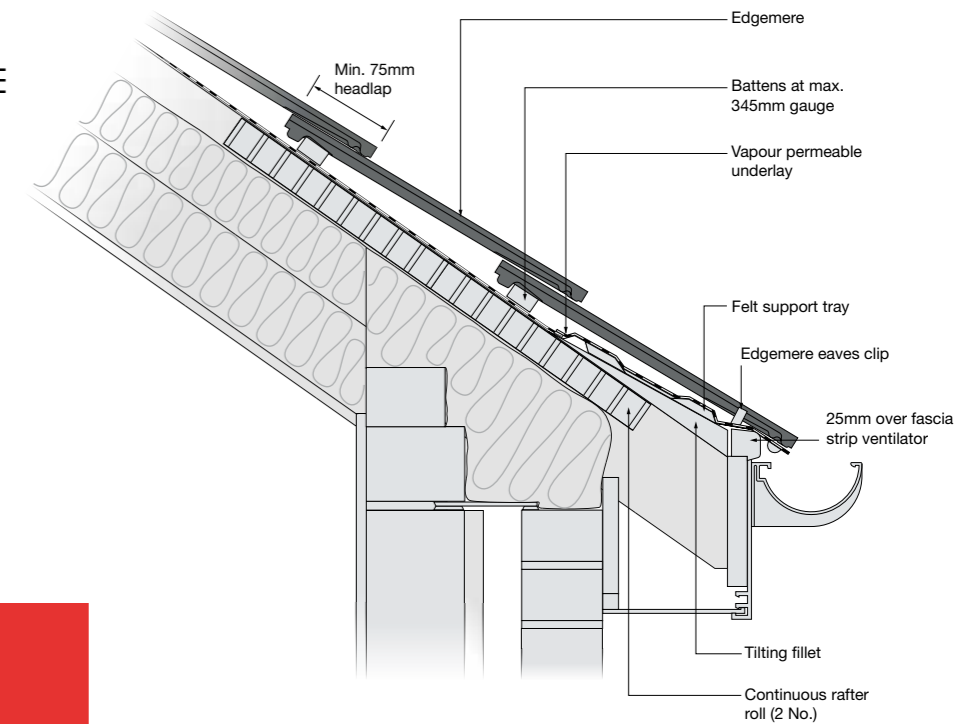

Specification toolkit

Marley provides a comprehensive technical service and a range of online tools to ensure design performance and compliance to the latest Building Regulations and NHBC Technical Standards.

- ▲ Fixing specifications
- ▲ NBS clauses
- ▲ CAD details
- ▲ BIM models

Visit marley.co.uk/specifying

SELECTED EAVES DETAILS

UNIVERSAL 25MM EAVES VENT SYSTEM WITH MODERN INTERLOCKING TILES

▲ shown with vapour permeable underlay



UNIVERSAL 25MM EAVES VENT SYSTEM WITH EDEN CLAY INTERLOCKING TILES

▲ cold roof with vapour permeable or non-breathable underlay

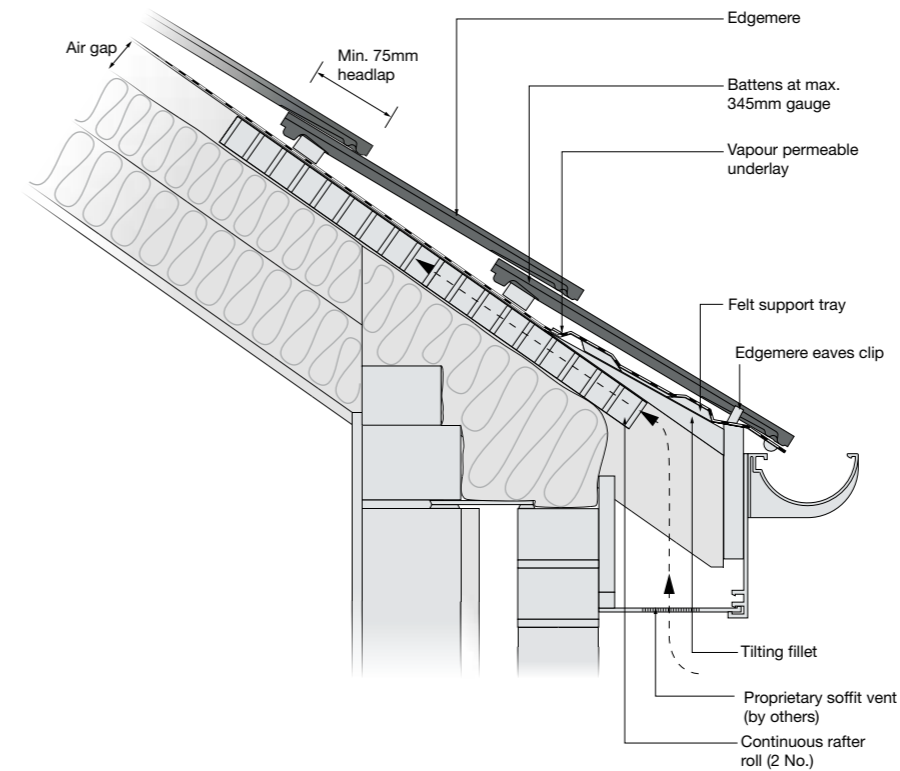
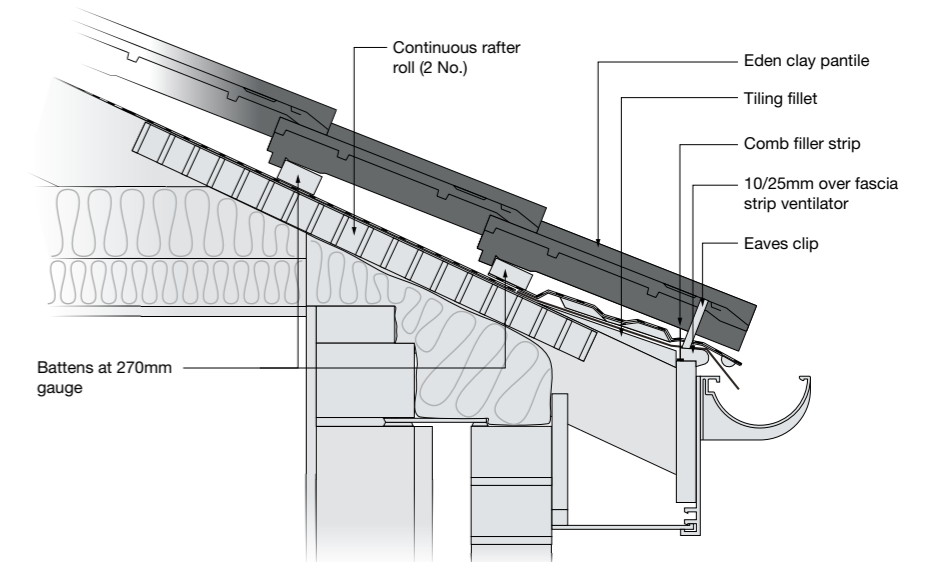

STANDARD EAVES WITH PROPRIETARY SOFFIT VENT AND EDGEREMERE

Suitable for all tiles, slates and roof pitches.

- ▲ warm roof with vapour permeable underlay shown
- ▲ provide proprietary soffit vent to provide 25,000mm²/m free vent area
- ▲ fix rafter roll to ensure air gap over insulation at wall plate
- ▲ ensure underlay is supported at eaves using either proprietary felt support tray or plywood board
- ▲ ensure fascia board or tilting fillet is fixed at correct height to maintain eaves course slates at same pitch as the main roof

Specification toolkit

Marley provides a comprehensive technical service and a range of online tools to ensure design performance and compliance to the latest Building Regulations and NHBC Technical Standards.

- ▲ Fixing specifications
- ▲ NBS clauses
- ▲ CAD details
- ▲ BIM models

Visit marley.co.uk/specifying

Verge

The verge is one of the most exposed parts of a roof and is prone to wind-driven rain and wind vortices, which can affect the integrity of the tiles or slates. The choice of verge construction is often dictated by the type of tile or slate being used.

The verge occurs at the roof's junction with the gable end wall and is normally at right angles to the eaves and ridge. Verge construction usually takes the following form – the external wall construction is built up to a level with the top of the rafters to allow the roof covering to oversail the wall with a soffit and sloping bargeboard.

Dry fix cloak verge tiles and units are available to suit a range of Marley tiles and slates and offer a low maintenance and secure method of fixing the verge tiles and slates.

SELECTED VERGE DETAILS

UNIVERSAL DRY VERGE AND EDGEMERE DRY VERGE

Universal Dry Verge is suitable for Anglia, Double Roman, Ludlow Major, Ludlow Plus, Mendip, Mendip 12.5, Modern, Duo Modern, and Wessex interlocking tiles.

Edgemere Dry Verge can be used for Edgemere, Duo Edgemere and Riven Edgemere to give a sleeker finish.

- ▲ maximum pitch for duo-pitch and mono-pitch roof is 55° (when used with steep-pitch dry ridge system)
- ▲ suitable for verges with or without bargeboard
- ▲ when using sarking, ensure outer wall or bargeboard is brought up to underside of tiling battens
- ▲ finish tiling battens 50mm beyond gable brickwork or bargeboard to a true line
- ▲ mechanically fixes all verge tiles in accordance with BS 5534
- ▲ for ridges/mono-ridges, fit PVCu ridge end cap



Specification toolkit

Marley provides a comprehensive technical service and a range of online tools to ensure design performance and compliance to the latest Building Regulations and NHBC Technical Standards.

- ▲ Fixing specifications
- ▲ NBS clauses
- ▲ CAD details
- ▲ BIM models

Visit [marley.co.uk/specifying](https://www.marley.co.uk/specifying)

CONTINUOUS DRY VERGE

Suitable for Ashmore and Edgemere interlocking tiles, and clay and concrete plain tiles.

- ▲ finish tiling battens flush with the wall or bargeboard
- ▲ Install tiles at the verge to the correct alignment and bond. Use purpose made half tiles, tile-and-a-half-tiles or three-quarter-width tiles as required
- ▲ mechanically fix all verge tiles in accordance with BS 5534
- ▲ at ridge/mono ridge fit PVCu end cap or Block End Ridge fittings

SELECTED VERGE DETAILS

BEDDED VERGE WITH INTERLOCKING TILES

Suitable for clay and concrete plain tiles, interlocking tiles and slates.

- ▲ ensure undercloak does not tilt towards gable
- ▲ verge overhang should be 38mm-50mm
- ▲ mechanically fix all verge tiles in accordance with BS 5534
- ▲ fit verge clips to both left hand and right hand verges where required

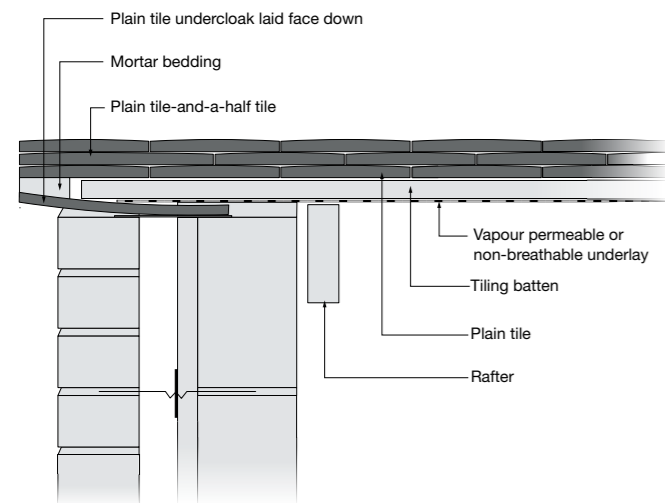
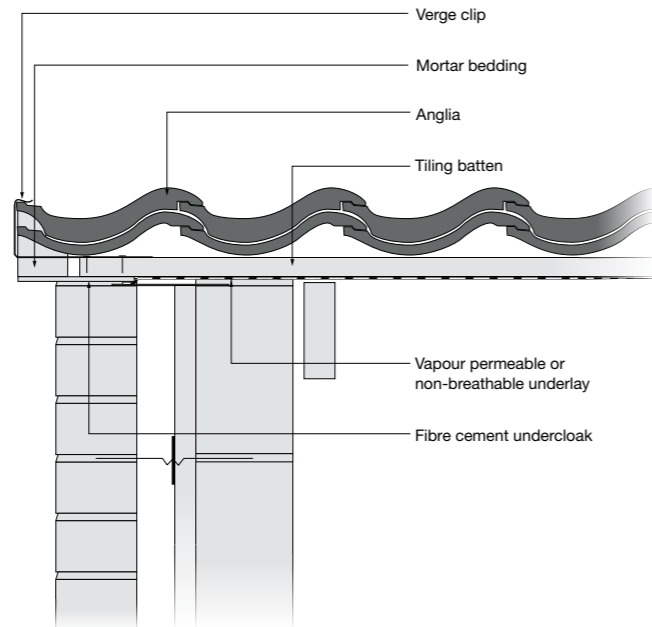

BEDDED VERGE WITH PLAIN TILES

Suitable for all plain tiles.

- ▲ form using tile and tile-and-a-half tiles in alternate courses
- ▲ use undercloak of either fibre cement laid with slope away from outer wall or plain tiles laid face down and overhanging wall
- ▲ verge overhang to be 38mm-50mm
- ▲ fully nail all tiles at verge where possible
- ▲ mortar bedding to comply with tensile board strength in BS 5534

ASHMORE DRY VERGE SYSTEM

Compatible with Ashmore tiles and concrete interlocking plain tiles.

- ▲ suitable for verges with or without bargeboard
- ▲ when using sarking, ensure outer wall or bargeboard is brought up to underside of tiling battens
- ▲ finish tiling battens 45mm beyond gable brickwork or bargeboard to a true line
- ▲ lay roof tiles with overhang of 45mm for using tile shunt and/or half tiles as required
- ▲ mechanically fix all verge tiles in accordance with BS 5534
- ▲ at ridge/mono-ridge fit PVCu ridge end cap



Specification toolkit

Marley provides a comprehensive technical service and a range of online tools to ensure design performance and compliance to the latest Building Regulations and NHBC Technical Standards.

- ▲ Fixing specifications
- ▲ NBS clauses
- ▲ CAD details
- ▲ BIM models

Visit marley.co.uk/specifying



INTERLOCKING CLOAK VERGE WITH INTERLOCKING TILES

Suitable for Mendip and Double Roman interlocking tiles.

- ▲ maximum pitch for duo-pitch and mono-pitch roofs is 45° (55° if top cloak verge tiles are mitred)
- ▲ not suitable for raking verges
- ▲ suitable for tile laps 75mm-115mm (305mm-345mm gauge)
- ▲ Use tile shunt and half tiles to reduce overhang to minimum
- ▲ for pitches over 30°, where no fixing for ends of tiling battens, use double course of battens secured over at least two rafters
- ▲ fix each cloak verge tile with special fixings supplied
- ▲ finish ridge with block end ridge tiles (duo or mono)

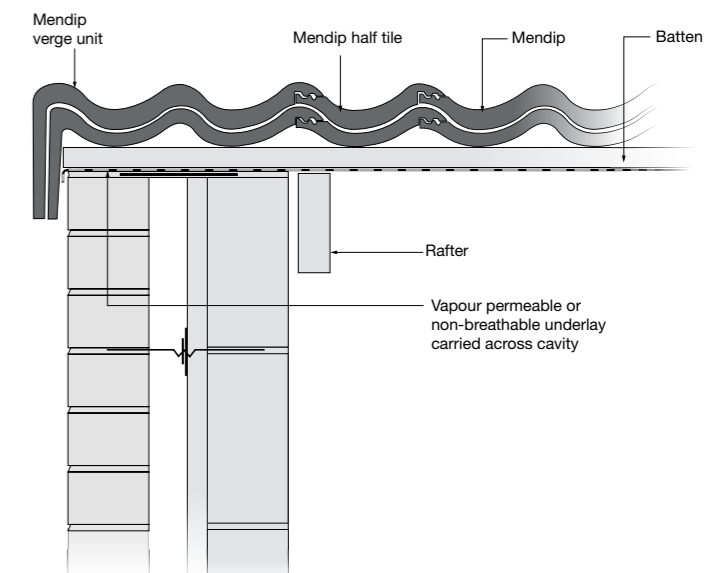

SELECTED VERGE DETAILS

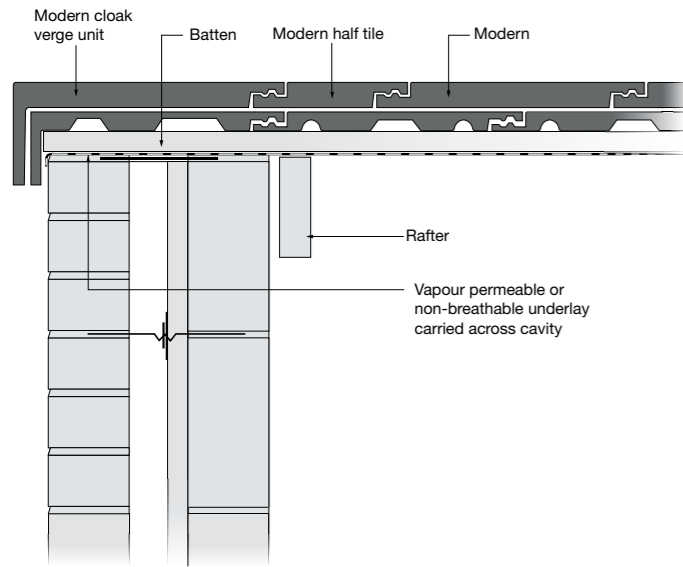

INTERLOCKING CLOAK VERGE WITH MODERN INTERLOCKING TILES

Suitable for Modern interlocking tiles.

- ▲ maximum pitch for duo-pitch and mono-pitch roofs is 45° (55° if top cloak verge tiles are mitred)
- ▲ not suitable for raking verges
- ▲ suitable for tile laps 75mm-115mm (305mm-345mm gauge)
- ▲ use tile shunt and half tiles to reduce overhang to minimum
- ▲ for pitches over 30°, where no fixing for ends of tiling battens, use double course of battens secured over at least two rafters
- ▲ fix each cloak verge tile with special fixings supplied
- ▲ finish ridge with block end ridge tiles (duo or mono)

PLAIN TILE CLOAK VERGE (CONCRETE)

Suitable for Plain tiles.

- ▲ maximum pitch for duo-pitch and mono-pitch roofs is 55° (mitre top cloak verge tiles if required)
- ▲ not suitable for raking verges
- ▲ finish tiling battens flush with edge of bargeboard or brickwork
- ▲ complete verge using cloak verge tiles in alternate courses with tile and a half tiles
- ▲ fix all tiles with 2 no. 38mm x 2.65mm aluminium nails
- ▲ at apex of roof/verge fit block end ridge tile

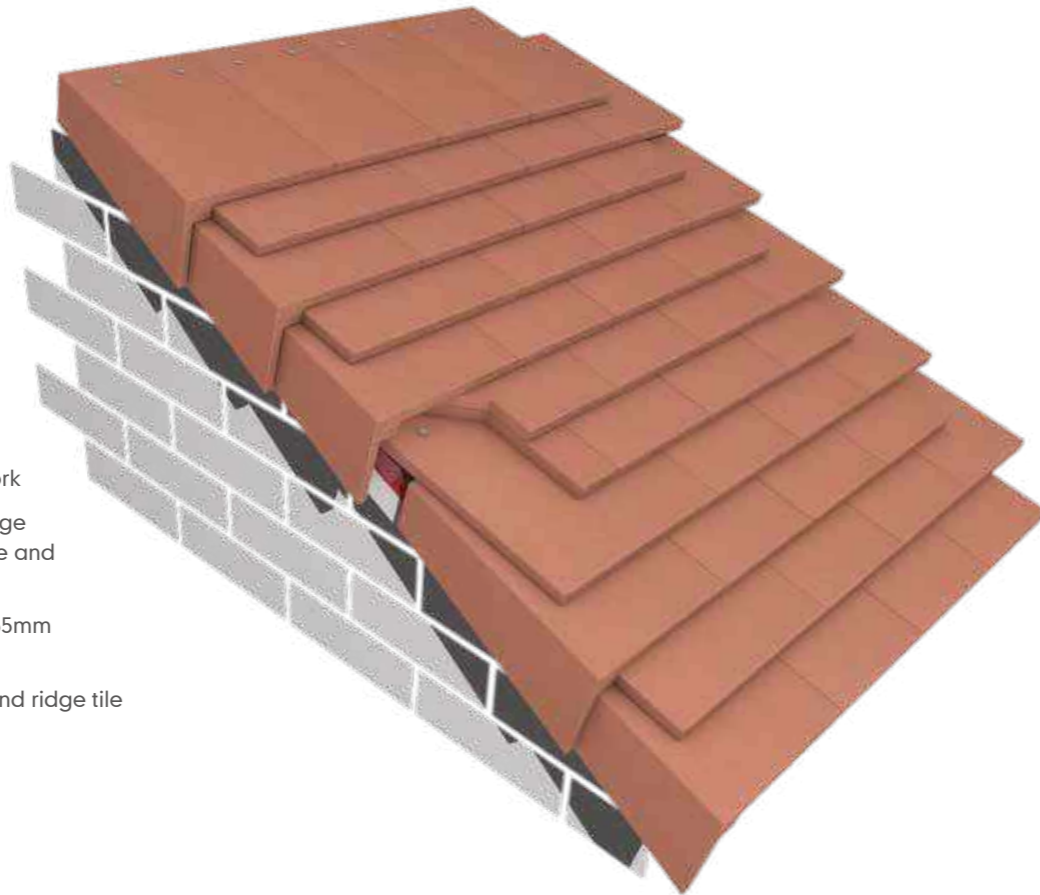

Hips

A hip occurs where two roof slopes of any pitch meet, forming a junction which water runs away from. Commonly, the two roof slopes will intersect at right angles on plan, but other plan angles are also common, as in a hexagonal or octagonal shaped roof design. A pyramid roof will have four hips meeting at an apex.

The junction of the tiles between the two roof slopes can be weathered using purpose-made hip tiles or cappings, which are normally of a flatter angle than their ridge counterparts. Alternatively, the junction can be weathered using proprietary soakers under close-mitred tiles or slates. This provides a neat, clean, sharp edge at the hip junction.

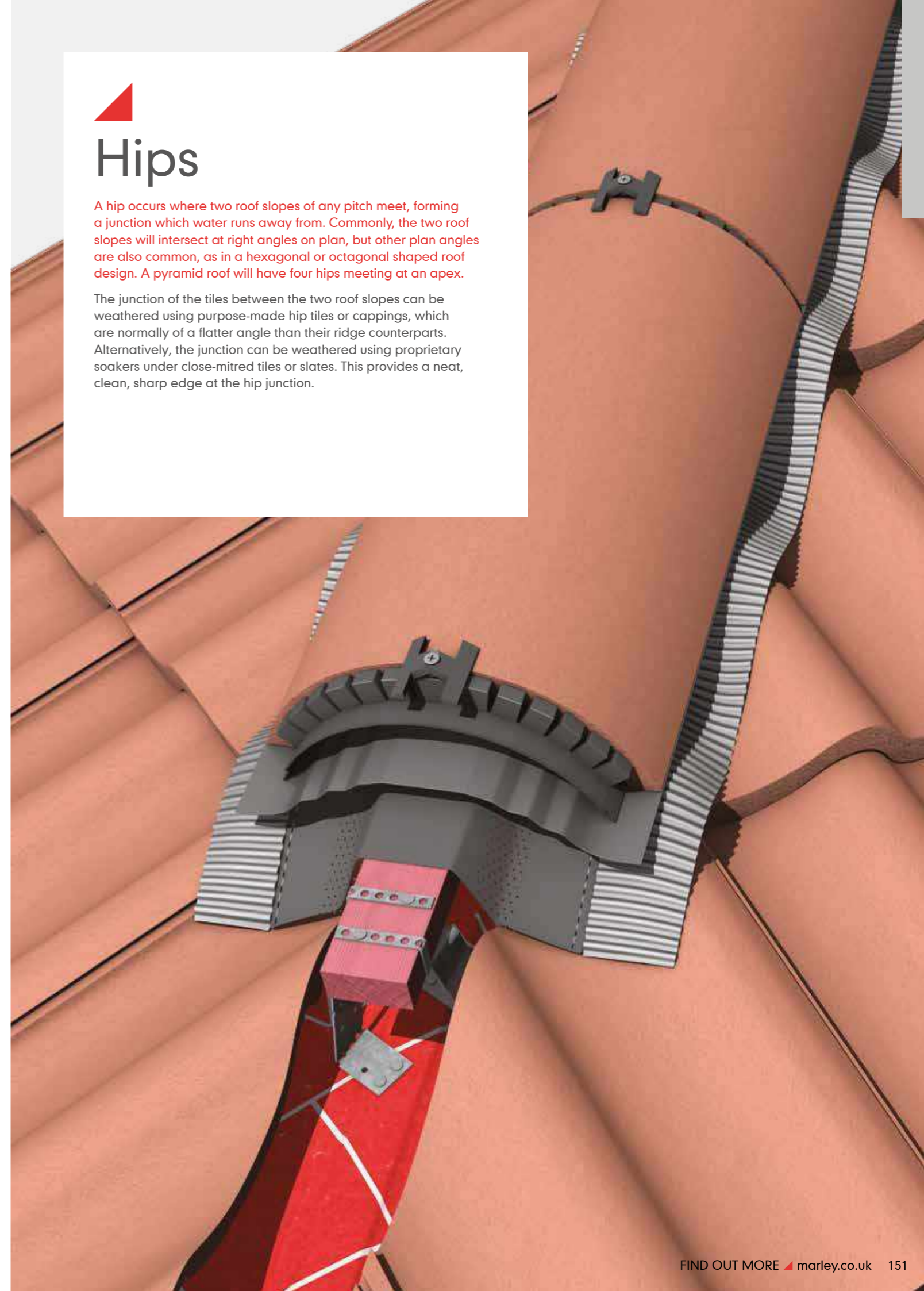

SELECTED HIP DETAILS

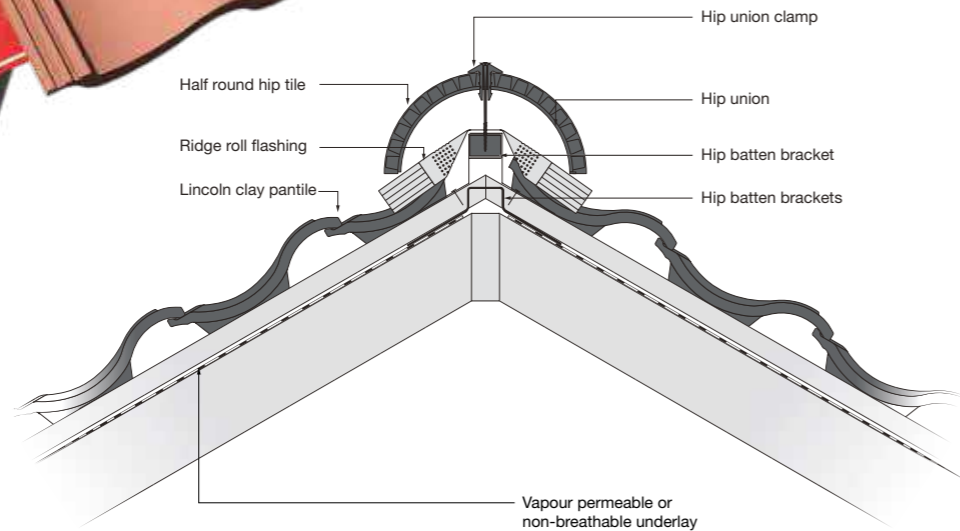
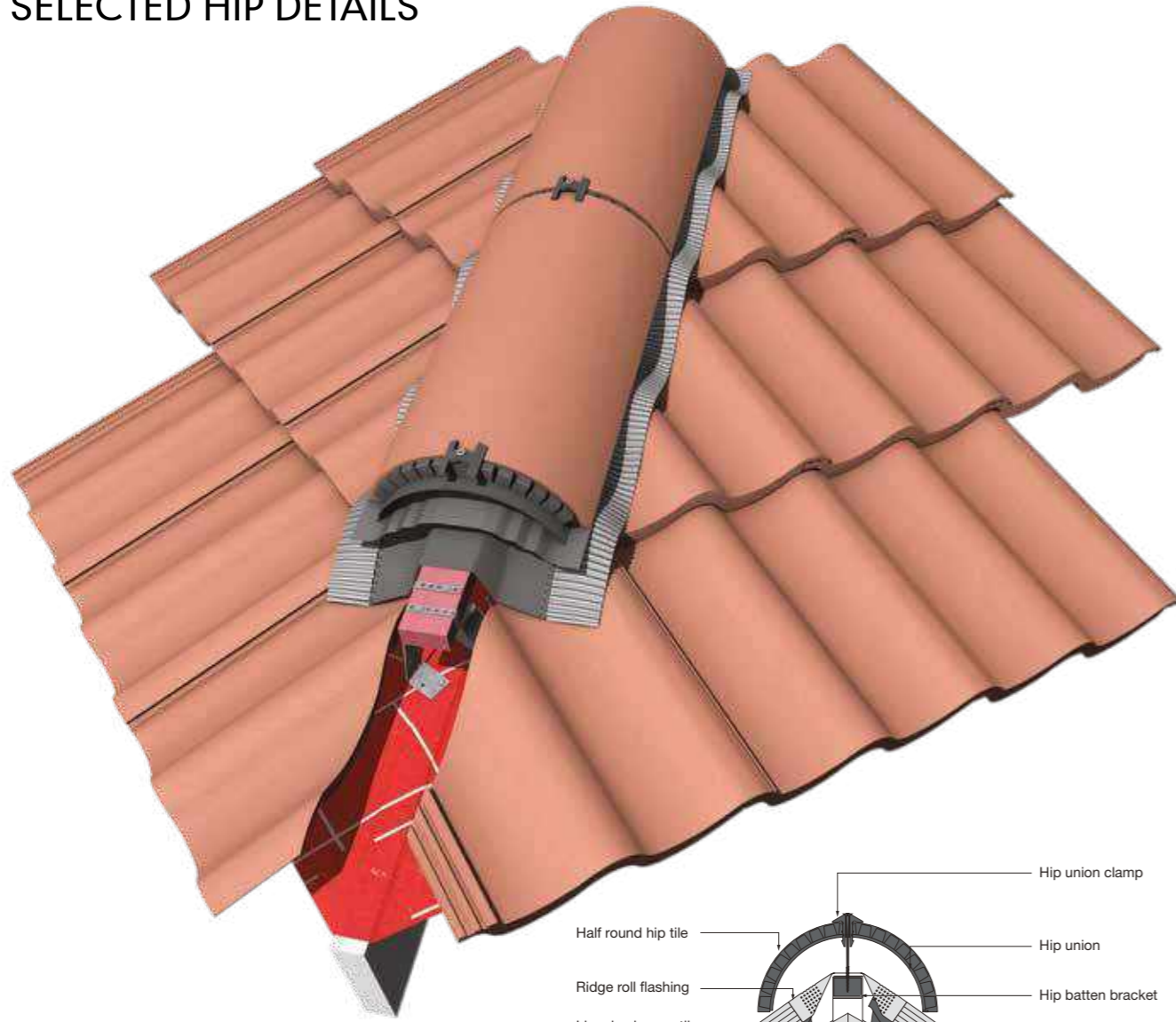

UNIVERSAL HIPFAST SYSTEM WITH INTERLOCKING TILES

Suitable for all interlocking tiles and plan angles and where the pitch either side of the hip varies by a maximum 5°.

- ▲ maximum rafter pitch (45° Ashmore; 50° Edgemere/Duo Edgemere, Modern/Duo Modern, Ludlow Plus; 55° Ludlow Major and Double Roman, 60° Plain, Mendip, Wessex, Anglia and Lincoln)
- ▲ provides additional ventilation to roof void when a 5mm gap in the underlay is used in conjunction with either eaves or ridge ventilated systems or ventilation tiles
- ▲ use one or two thicknesses of 50mm x 25mm batten to fit batten brackets
- ▲ use block end hip tile at eaves
- ▲ mechanically fix each hip tile via hip unions and clamps
- ▲ complete hip at ridge with soaker flashing

DRY HIP SYSTEM

Suitable for all tiles and slates using third round or Modern hip tiles.

- ▲ maximum rafter pitch 55° (45° when using dry ridge)
- ▲ suitable for hips with plan angle of 90° and where the pitch either side of the hip varies by a maximum 5°
- ▲ secures raking cut tiles or interlocking slates using head and tail clips
- ▲ secure PVCu batten section to hip tree or batten using screws and expansion blocks
- ▲ mechanically fix each hip tile to PVCu batten section via hip unions
- ▲ complete hip at ridge apex with dry hip apex cap

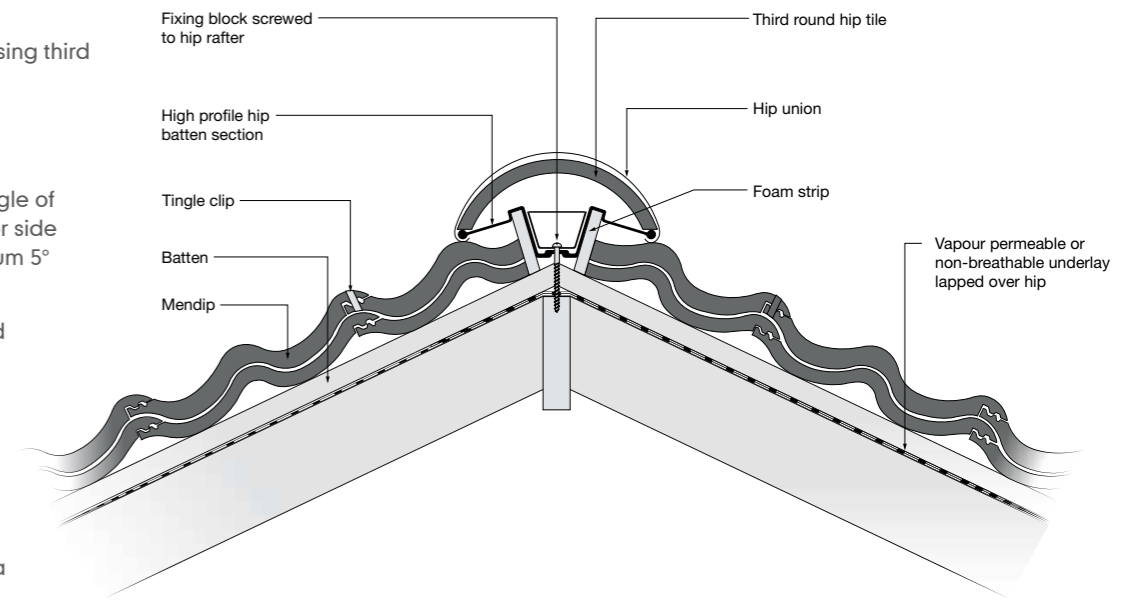

SHINGLE HIP

- ▲ Either site-made or factory-assembled hip units may be used but both types must have alternate overlaps and concealed nailing
- ▲ Each shingle is chamfered and fixed with an alternate overlap
- ▲ Nails must be longer than those used for the body of the roof and of sufficient length to penetrate 19mm into the battens
- ▲ Lay a strip of felt on edge over hip covered by hip cappings

Specification toolkit

Marley provides a comprehensive technical service and a range of online tools to ensure design performance and compliance to the latest Building Regulations and NHBC Technical Standards.

- ▲ Fixing specifications
- ▲ NBS clauses
- ▲ CAD details
- ▲ BIM models

Visit marley.co.uk/specifying

For relationship of roof pitch to internal angle of hip, please see tables on page 179.

SELECTED HIP DETAILS

For relationship of roof pitch to internal angle of hip, please see tables on page 179.

GRANNY BONNET HIP WITH CLAY PLAIN TILES

Suitable for all plain tiles.

- ▲ maximum rafter pitch 60° (clay) and 50° (concrete)
- ▲ use on hips with plan angle of 90° and equal pitches on adjacent roof slopes
- ▲ fix to hip batten using 70mm x 3.35mm aluminium nail
- ▲ bed and point with 3:1 sand/cement mortar to BS 5534
- ▲ complete hip at ridge or top abutment with lead saddle

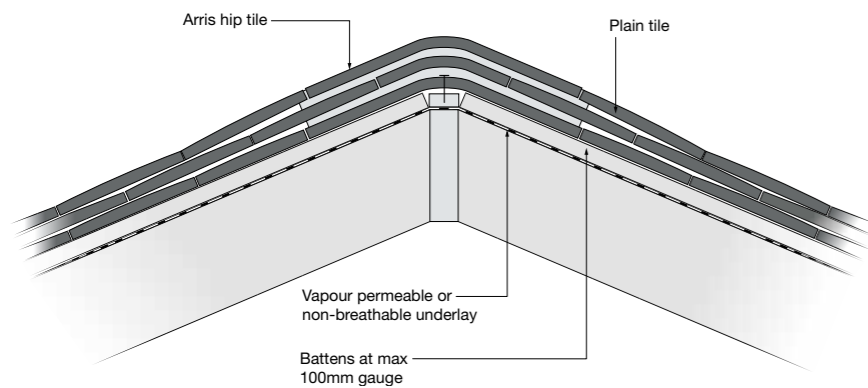
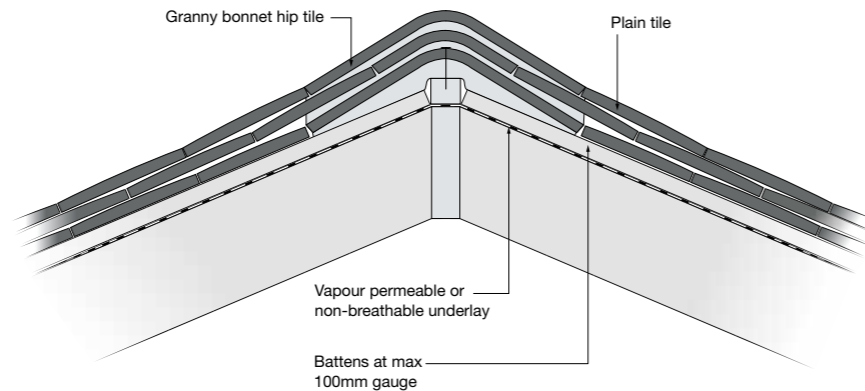

ARRIS HIP WITH CLAY PLAIN TILES

Suitable for all plain tiles.

- ▲ maximum rafter pitch 50° (clay) and 40° (concrete)
- ▲ use on hips with plan angle of 90° and equal pitches on adjacent roof slopes
- ▲ fix to hip batten using 65mm x 3.35mm aluminium nail
- ▲ bed top of tiles with 3:1 sand/cement mortar to BS 5534
- ▲ complete hip at ridge or top abutment with lead saddle



MORTAR BEDDED SECURITY HIP

Suitable for concrete, clay plain and interlocking tiles. Vapour permeable underlay shown.

- ▲ maximum rafter pitch 45°
- ▲ fix hip units to hip tree using ridge clamp and 75mm stainless steel screw
- ▲ complete hip at ridge apex with three way mitre

BS 5534 and mortar hips

Under the British Standard, the use of mortar as a sole means of fixing roof tiles and fittings is insufficient.

Not only should careful consideration be given to the creation of a suitable roof mortar through the correct sand and cement mix, but tiles or fittings bedded with this mortar must also be accompanied by a mechanical fix.

Marley solution: Mortar bedded security ridge and hip kits

Where mortar bedding is required, Marley now offers a mortar bedded security ridge and hip kit, providing installers with enough mechanical fixings to secure up to six metres of each. In addition, clips for mechanically fixing small tile cuts at the hip and valley are also available. See pages 00-00.

Dentil slips

Suitable dentil slips for concrete and clay interlocking tiles can be made using cut pieces of tile. For full details of how to make dentil slips, please refer to our Sitework Guide.

Specification toolkit

Marley provides a comprehensive technical service and a range of online tools to ensure design performance and compliance to the latest Building Regulations and NHBC Technical Standards.

- ▲ Fixing specifications
- ▲ NBS clauses
- ▲ CAD details
- ▲ BIM models

Visit marley.co.uk/specifying



Valleys

Inclined roof valleys are the most vulnerable part of any roof design in respect of weathertightness, as they are collecting the rainwater from the two roof slopes (of any pitch) which meet at an internal corner.

In most cases, the internal corner will be 90° on plan, but could be any angle subtended between the two slopes. The exact pitch of a valley is always less than the rafter pitch, which should always be taken into account when selecting a valley tile or valley lining. Special plain tile valley fittings are available to cater for unequal valley angles and pitches.

The width of an open valley trough should be determined in accordance with BS 5534 (reproduced in tables 6 and 7, page 179), which takes into account the volume of rainwater at specified flow rates draining from plan areas and roof pitches.

VALLEY PITCH LENGTH AND LAP TABLE

Rafter pitch	Maximum valley length	Minimum lap length
15-17°	10m	400mm
17.5-22°	12m	350mm
22.5-29°	14.5m	300mm
30-34°	15m	250mm
35-39°	15.5m	200mm
40-44°	16.5m	150mm
45-49°	17.5m	150mm
50-55°	18.5m	150mm

SELECTED VALLEY DETAILS

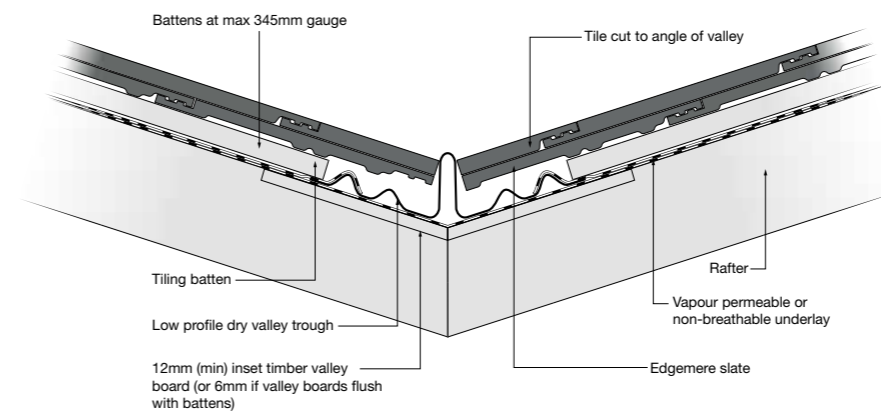

UNIVERSAL GRP DRY VALLEY WITH INTERLOCKING TILES

Suitable for all profiled large format concrete interlocking tiles (Ludlow Major, Duo Modern, Modern, the Edgemere range, Wessex, Mendip and Double Roman).

- ▲ minimum rafter pitch 15°, maximum 60°
- ▲ maximum valley length 8m
- ▲ suitable for all plan angles and where the pitch either side of the valley varies by a maximum of 20°
- ▲ provide continuous support for valley trough using min. 12mm timber ply boards inset between rafters or 6mm continuous ply boards laid over rafters

- ▲ tightly butt tiles or slates to central upstand of valley units to prevent ingress of birds or vermin
- ▲ provide metal apron at foot of valley and dress into gutter at eaves. For rafter pitches below 25° cut fascia board to maintain valley pitch
- ▲ nail or clip adjacent tiles to the valley and avoid small cuts by using half tiles as penultimate tile to valley (Mendip, Double Roman and Modern only). Fix smaller cut tiles with secret cut tile clips
- ▲ complete top of valley with a lead saddle

For relationship of valley angle to roof pitch and min. widths of lead for valley gutters, please see tables on page 179.

SELECTED VALLEY DETAILS



CLAY PLAIN TILES WITH PURPOSE MADE VALLEY TILES

Suitable for all clay plain tiles. Vapour permeable underlay shown.

- ▲ suitable for roof pitches of 30-50°. A range of valley tiles are available to suit roof pitch
- ▲ suitable for a plan angle of 90° only and equal pitches either side of the valley
- ▲ provide continuous support for valley tile using timber lay boards of battens inset between rafters
- ▲ use tile-and-a-half tiles adjacent to valley tile to avoid small cuts
- ▲ complete top of valley with a lead saddle

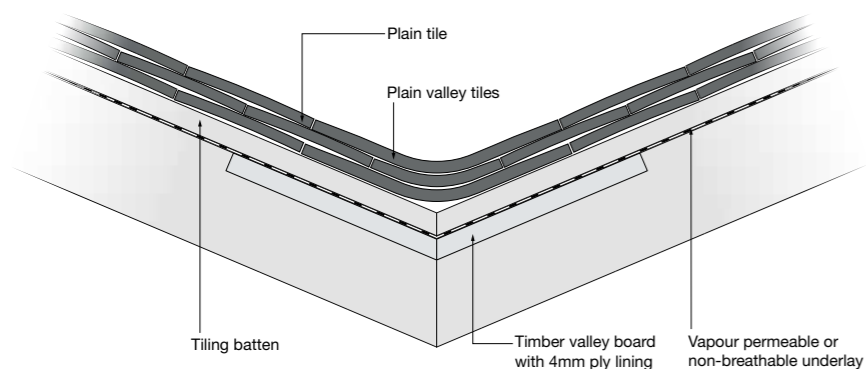

VALLEY TILE WITH PLAIN TILES

Suitable for concrete plain tiles.

- ▲ maximum rafter pitch 50°
- ▲ suitable for a plan angle of 90° only and equal pitches either side of the valley
- ▲ provide continuous support for valley tile using timber lay boards or battens inset between rafters
- ▲ use tile-and-a-half tiles adjacent to valley tile to avoid small cuts
- ▲ complete top of valley with a lead saddle

SHEET LEAD VALLEY WITH INTERLOCKING TILES

Suitable for profiled interlocking tiles.

- ▲ minimum rafter pitch 15°
- ▲ suitable for all plan angles and where the pitch either side of the valley varies
- ▲ provide continuous support for metal valley lining using timber lay boards inset between rafters with 4mm ply lining board over
- ▲ form 125mm minimum gap between raking cut tiles (for pitches below 35° or valley lengths over 5m increase width as per Table 7, page 179)
- ▲ carry metal lining into gutter at eaves. For rafter pitches below 25°, cut fascia board to maintain valley pitch
- ▲ cut tiles to clean rake and bed with mortar onto undercloak
- ▲ nail or clip adjacent tiles to the valley and avoid small cuts by using half tiles as penultimate tile to valley (Mendip and Double Roman only)
- ▲ 3:1 sand/cement mortar to BS 5534
- ▲ complete top of valley with a lead saddle

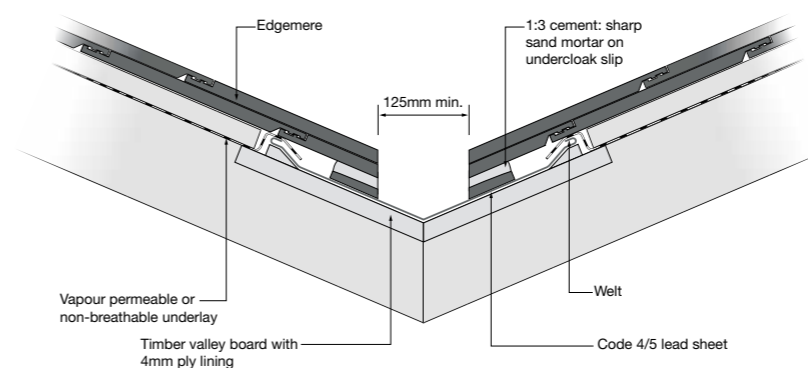
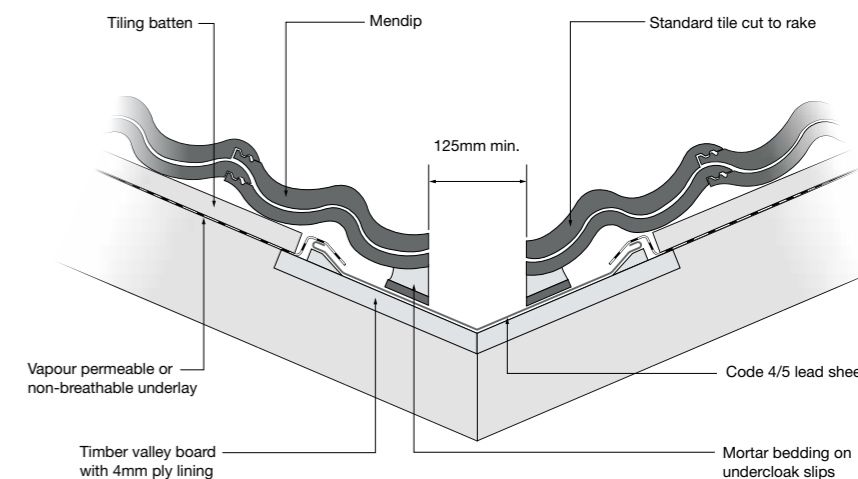

SHEET LEAD VALLEY WITH CONCRETE INTERLOCKING SLATES

Suitable for Modern, Duo Modern and the Edgemere range of interlocking slates.

- ▲ minimum rafter pitch 17.5°
- ▲ suitable for all plan angles and where the pitch either side of the valley varies
- ▲ provide continuous support for metal valley lining using timber lay boards inset between rafters with 4mm ply lining board over
- ▲ form 125mm minimum gap between raking cut tiles (for pitches below 35° or valley lengths over 5m increase width as per Table 7, page 179)
- ▲ carry metal lining into gutter at eaves. For rafter pitches below 25°, cut fascia board to maintain valley pitch
- ▲ cut tiles to clean rake and bed with mortar onto undercloak
- ▲ nail or clip adjacent tiles to the valley
- ▲ 3:1 sand/cement mortar to BS 5534
- ▲ complete top of valley with a lead saddle



Specification toolkit

Marley provides a comprehensive technical service and a range of online tools to ensure design performance and compliance to the latest Building Regulations and NHBC Technical Standards.

- ▲ Fixing specifications
- ▲ NBS clauses
- ▲ CAD details
- ▲ BIM models

Visit marley.co.uk/specifying

For relationship of valley angle to roof pitch and min. widths of lead for valley gutters, please see tables on page 179.

For relationship of valley angle to roof pitch and min. widths of lead for valley gutters, please see tables on page 179.

SHEET LEAD VALLEY WITH PLAIN TILES

Suitable for concrete or clay plain tiles.

- ▲ minimum rafter pitch 30°
- ▲ suitable for all plan angles and where the pitch either side of the valley varies
- ▲ provide continuous support for metal valley lining using timber lay boards inset between rafters with 4mm ply lining board over
- ▲ form 125mm minimum gap between raking cut tiles
- ▲ carry metal lining into gutter at eaves
- ▲ use tile-and-a-half tiles to minimise small cut tiles
- ▲ nail all adjacent tiles to the valley
- ▲ complete top of valley with a lead saddle

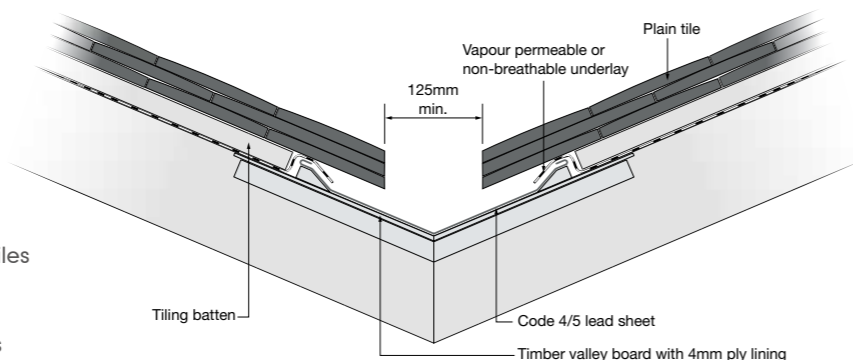

SHINGLE VALLEY

- ▲ valleys should be code 5 lead (or as specified) and should be at least 375mm in width
- ▲ lead should be coated with patination oil or bituminous paint where contact is made with the shingles or shakes
- ▲ shingles should lap the lead by not less than 178mm on each side
- ▲ flashings should be in accordance with good building practice and coated with patination oil or bituminous paint where contact is made with shingles or shakes



Specification toolkit

Marley provides a comprehensive technical service and a range of online tools to ensure design performance and compliance to the latest Building Regulations and NHBC Technical Standards.

- ▲ Fixing specifications
- ▲ NBS clauses
- ▲ CAD details
- ▲ BIM models

Visit marley.co.uk/specifying

Bonding gutters

Marley bonding gutters are an easy-to-install, lightweight and highly affordable way to reduce the need for mortar and lead at the junction between two different roof coverings. There are two versions available, depending on the tiles or slates being used.

Suitable for all tiles and slates. Low profile bonding gutter with a central upstand height of 70mm to suit slates, flat interlocking tiles and plain tiles. High profile with a central upstand height of 100mm to suit profiled tiles on one or both sides and also typical Scottish practice where there may be tiling battens on one side only.

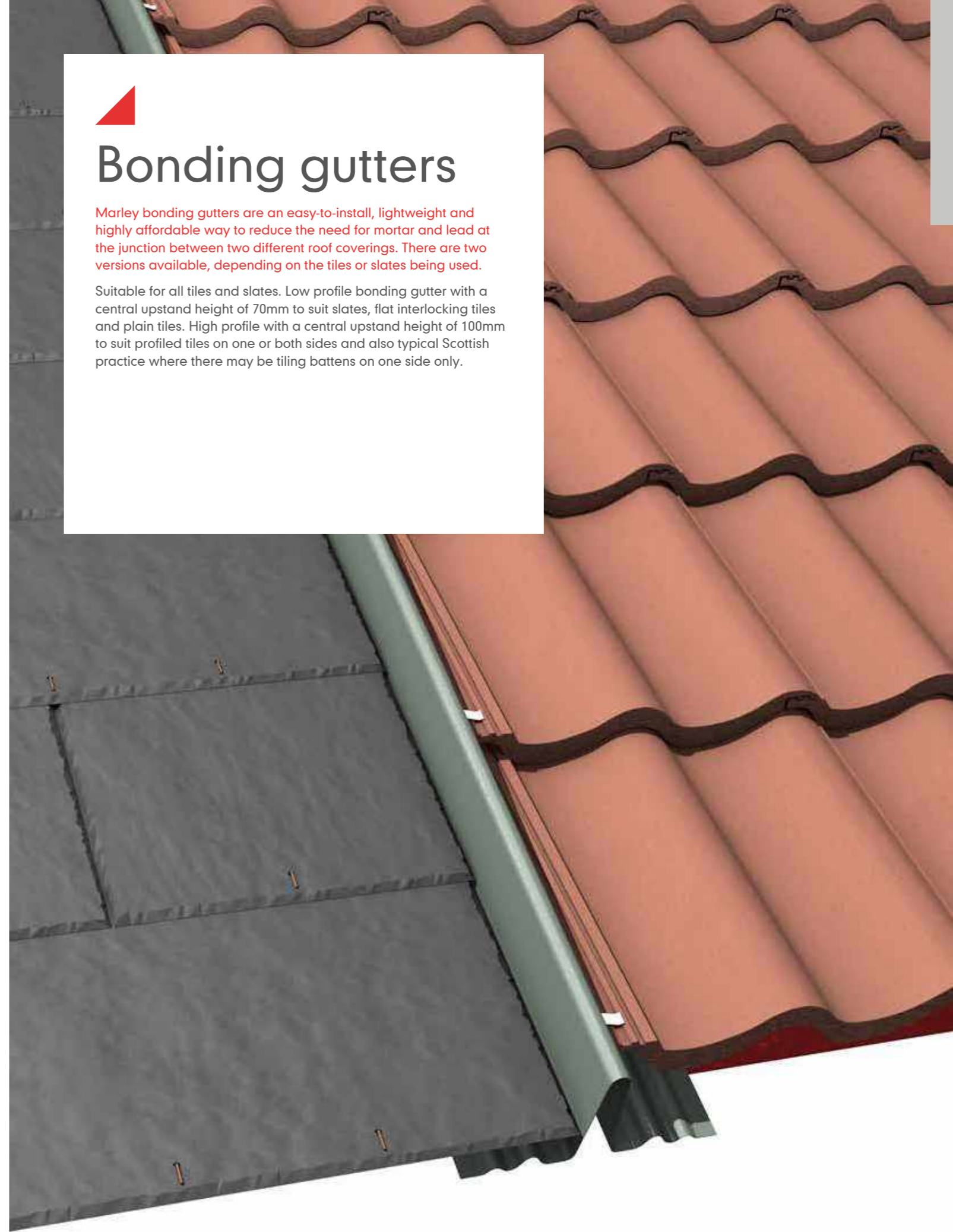

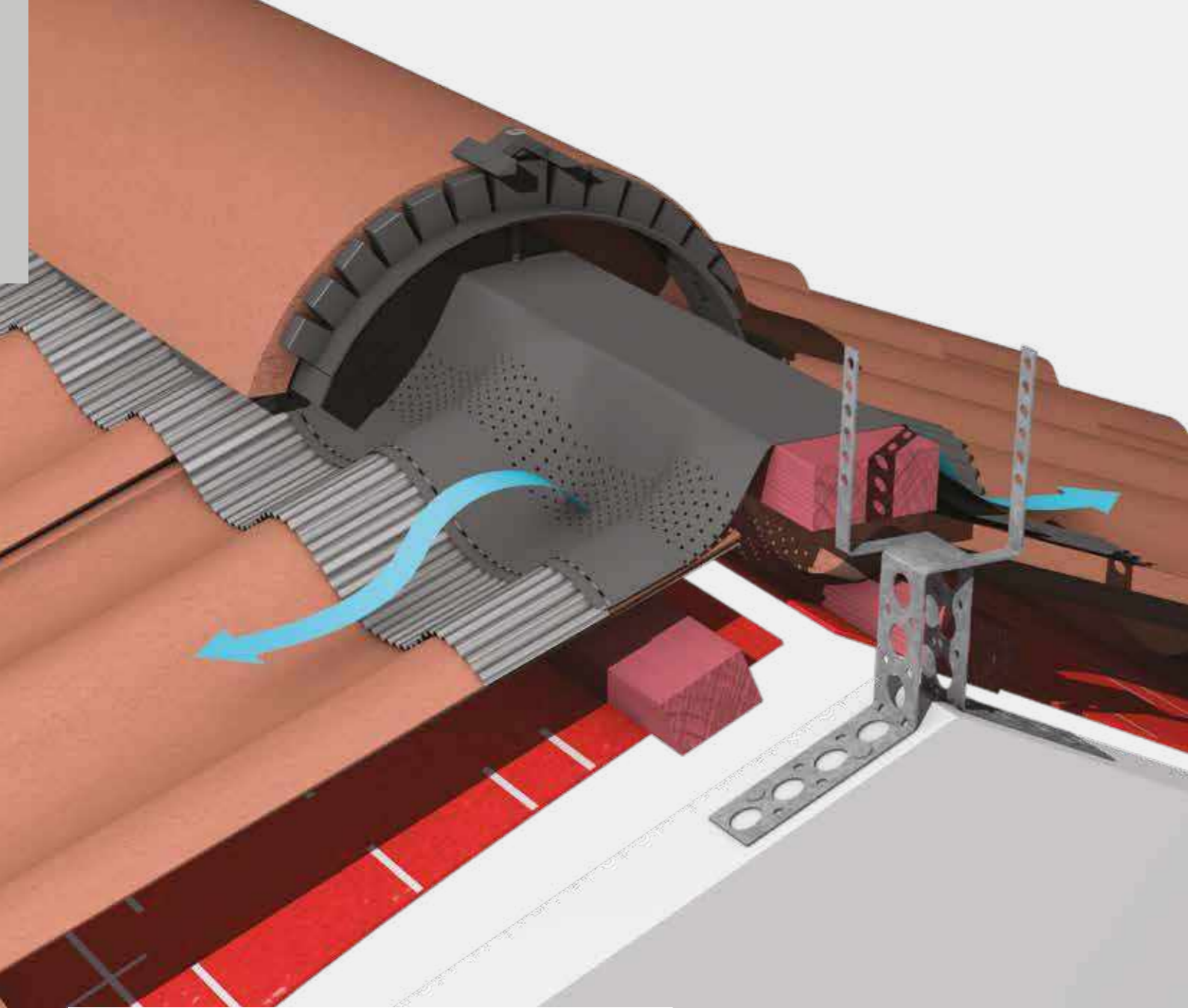

Ridges

The ridge is the most exposed part of a roof, and it is therefore important that it is well protected by the use of ridge tiles or cappings suited to the pitch of the roof and the type of roof tile or slate. All ridge units – even if mortared – should be mechanically fixed.

A ridge occurs at the highest point of the roof and is normally parallel with the eaves. Duo pitch ridges occur when two roof slopes meet at their upper edge. Where the top of one roof meets a vertical wall, it forms either a mono-pitch roof or a top abutment.

The ridge may also be used to terminate ventilation ducts and gas flue pipes.

The junction between ridges, hips, valleys and abutments must be suitably mitred and weathered using a proprietary saddle or flashing unit.

SELECTED RIDGE DETAILS

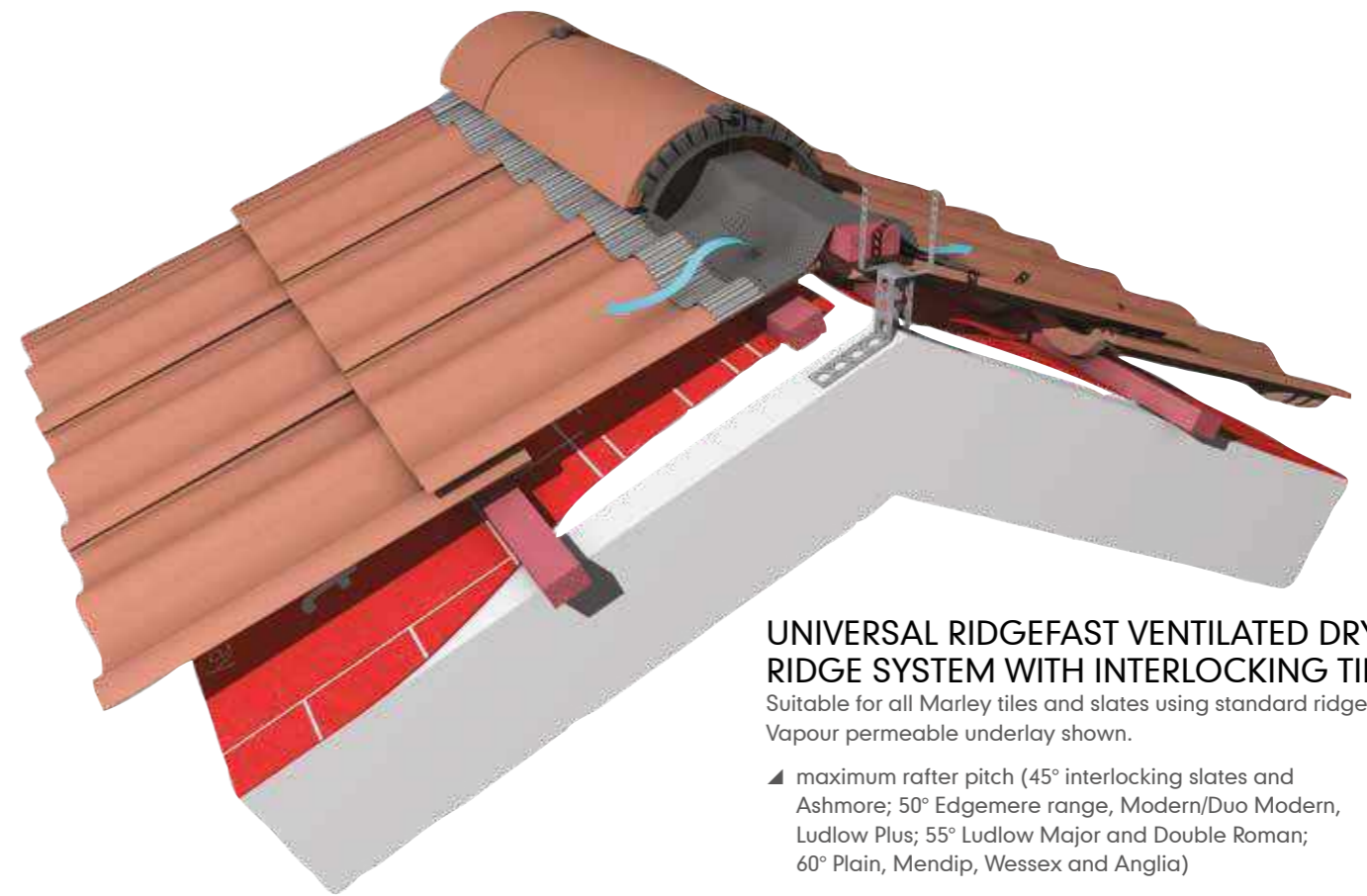

UNIVERSAL RIDGEFAST VENTILATED DRY RIDGE SYSTEM WITH INTERLOCKING TILES

Suitable for all Marley tiles and slates using standard ridges. Vapour permeable underlay shown.

- ▲ maximum rafter pitch (45° interlocking slates and Ashmore; 50° Edgemere range, Modern/Duo Modern, Ludlow Plus; 55° Ludlow Major and Double Roman; 60° Plain, Mendip, Wessex and Anglia)
- ▲ provides 5,000mm²/m free vent area at ridge apex
- ▲ ensure gap is provided in roof underlay to vent roof void
- ▲ use one or two thicknesses of 50mm x 25mm batten to fit batten brackets
- ▲ mechanically fix all top course tiles
- ▲ use block end ridge tile or PVC ridge end cap at ridge end

UNIVERSAL RIDGEFAST SYSTEM

- ▲ provides 5,000mm²/m free vent area at ridge apex
- ▲ ensure gap is provided in roof underlay to vent roof void
- ▲ use one or two thicknesses of 50mm x 25mm batten to fit batten brackets
- ▲ mechanically fix all top course tiles
- ▲ use ridge end tile

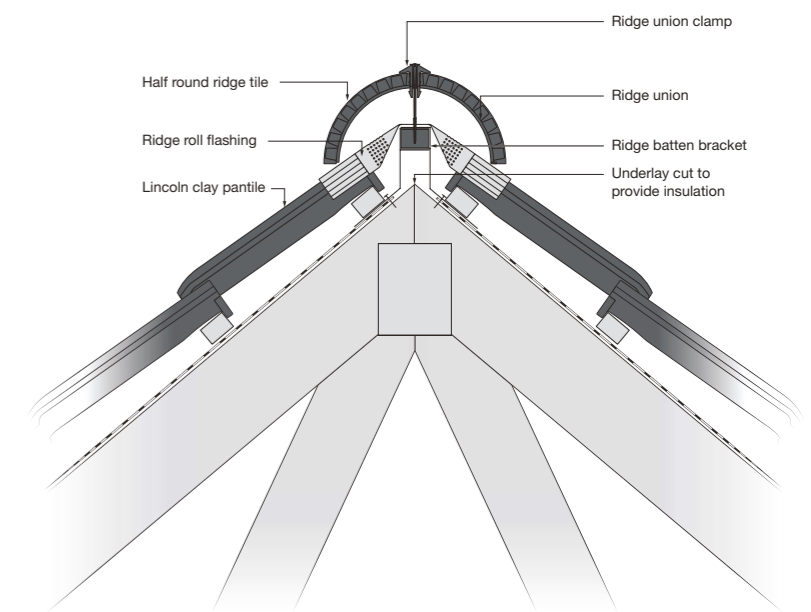

For relationship of internal angle of ridge tiles to roof, please see page 179.

SELECTED RIDGE DETAILS

VENTILATED DRY FIX MONO-RIDGE WITH INTERLOCKING TILES AND SEGMENTAL MONO-RIDGE TILES

Suitable for all concrete plain, interlocking tiles and slates (using concrete segmental mono-ridge tiles). Vapour permeable underlay shown.

- ▲ maximum rafter pitch 45° (55° using steep pitch ridge batten)
- ▲ provides 5,000mm²/m free vent area at ridge apex
- ▲ ensure gap is provided in roof underlay to vent roof void
- ▲ fix all top course tiles and slates
- ▲ mechanically fix each ridge tile via ridge unions
- ▲ complete ridge with segmental mono-ridge block end tile (LH and RH) or segmental mono-ridge end cap

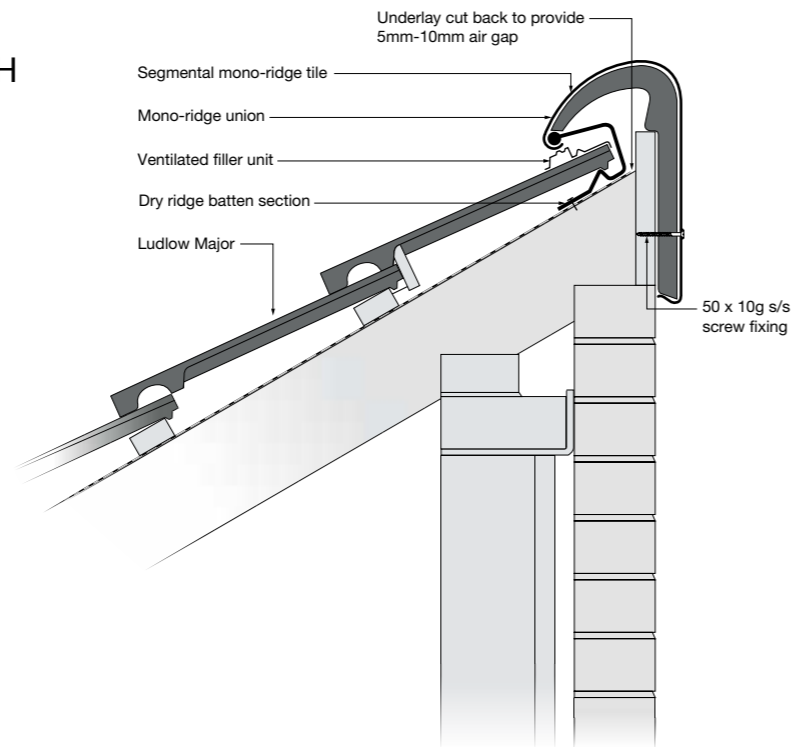

SHINGLES DUO PITCH RIDGE WITH VENTILATION – WARM ROOF DETAIL

- ▲ ridges may be formed on site by hand
- ▲ a piece of felt should be used beneath each capping piece
- ▲ this ridge detail shows Marley vapour permeable underlay with counterbattens

Specification toolkit

Marley provides a comprehensive technical service and a range of online tools to ensure design performance and compliance to the latest Building Regulations and NHBC Technical Standards.

- ▲ Fixing specifications
- ▲ NBS clauses
- ▲ CAD details
- ▲ BIM models

Visit marley.co.uk/specifying



RIDGE VENT TERMINAL WITH DRY RIDGE AND INTERLOCKING TILES

Suitable for all concrete tiles and slates (using Modern and Segmental ridge tiles). Vapour permeable underlay shown.

- ▲ maximum rafter pitch 45° (55° using steep pitch ridge batten)
- ▲ provides 9,500mm²/m free vent area at ridge apex
- ▲ locate between two adjacent rafters and 600mm from any flue outlet
- ▲ use plumbers accessory pack for connection to mechanical extract system
- ▲ ensure all ductwork is adequately supported

For relationship of internal angle of ridge tiles to roof, please see page 179.

SELECTED RIDGE DETAILS

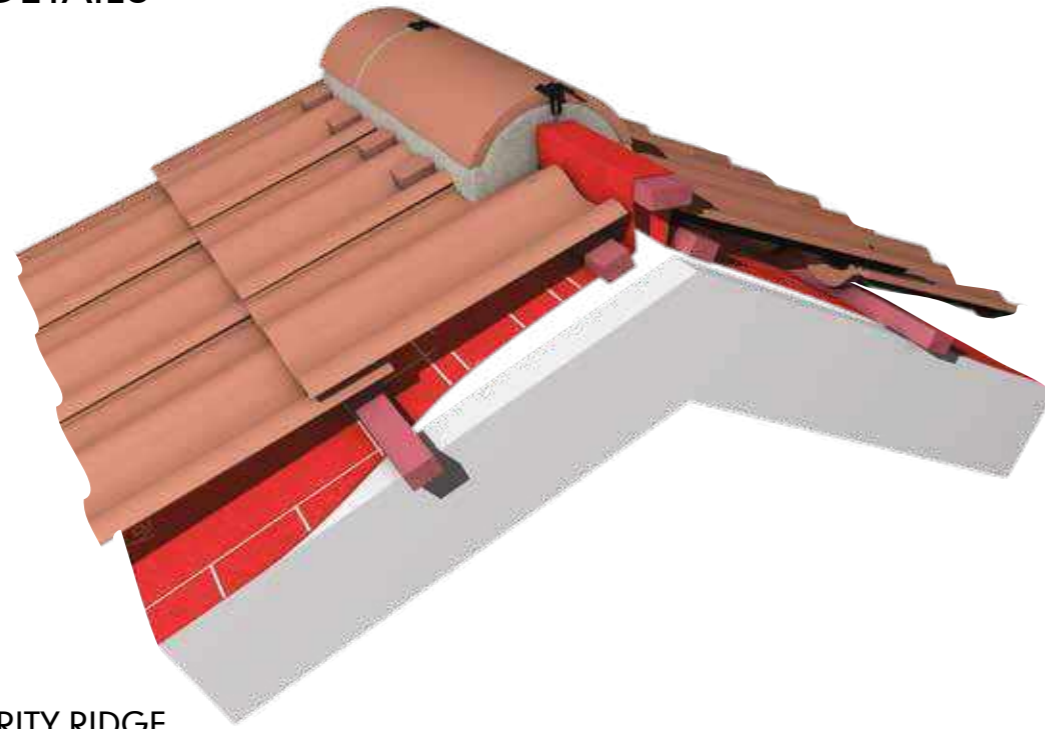

MORTAR BEDDED SECURITY RIDGE

Suitable for mortar bedded ridges. Vapour permeable underlay shown.

- ▲ security ridges are available for all clay or concrete angle, half round, third round, hogs back, capped angular, baby and decorative ridge tiles
- ▲ maximum rafter pitch 60°
- ▲ fix ridge units to ridge batten using ridge clamp and 75mm stainless steel screw
- ▲ mechanically fixes ridge tile in line with BS 5534 fixing guidelines

BS 5534 and mortar hips

Under the British Standard, the use of mortar as a sole means of fixing roof tiles and fittings is insufficient.

Not only should careful consideration be given to the creation of a suitable roof mortar through the correct sand and cement mix, but tiles or fittings bedded with this mortar must also be accompanied by a mechanical fix.

Marley solution: Mortar bedded security ridge and hip kits

Where mortar bedding is required, Marley now offers a mortar bedded security ridge and hip kit, providing installers with enough mechanical fixings to secure up to six metres of each. In addition, clips for mechanically fixing small tile cuts at the hip and valley are also available. See page 125.

MORTAR BEDDED SECURITY RIDGE (MECHANICAL FIXING)

- ▲ mechanically fix ridge tile in line with BS 5534 fixing guidelines
- ▲ security ridge packs are available for all angle, half round, third round, hogs back and decorative ridge tiles, except Roll Top ridges (Code 43605)

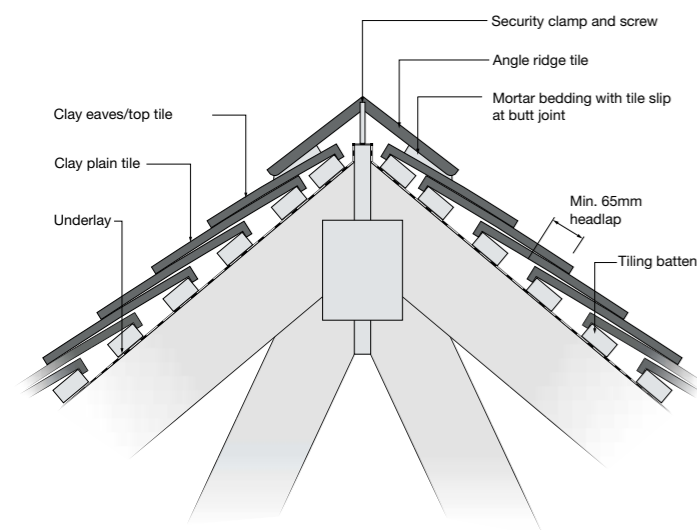

For relationship of internal angle of ridge tiles to roof, please see page 179.



Abutments

An abutment occurs where the edge of the roof slope meets a wall that rises above it. Normally, on a side abutment, this is at right angles to the eaves or ridge, but may be at an angle, in which case, it is referred to as a raking abutment.

It is best practice to ensure that rainwater runs away from a side abutment, but where this is not possible, an inclined valley should be created which is designed to cater for the water flow.

SELECTED ABUTMENT DETAILS

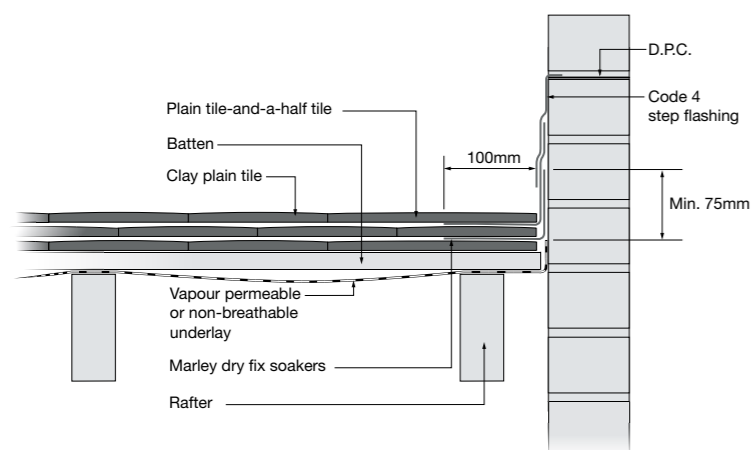

SIDE ABUTMENT WITH CLAY PLAIN TILES

Suitable for all concrete and clay plain tiles.

- ▲ bring tiles as close to abutment as possible
- ▲ use Code 3 lead soakers and Code 4 lead cover flashing

SIDE ABUTMENT WITH INTERLOCKING TILES

Suitable for all concrete and clay interlocking tiles. A secret gutter detail is required for flat interlocking tiles and slates.

- ▲ bring tiles as close to abutment as possible
- ▲ use Code 4 lead step-and-cover flashing dressed over tiles by 150mm minimum
- ▲ secure edge of flashing with copper clip
- ▲ fix all tiles adjacent to abutment

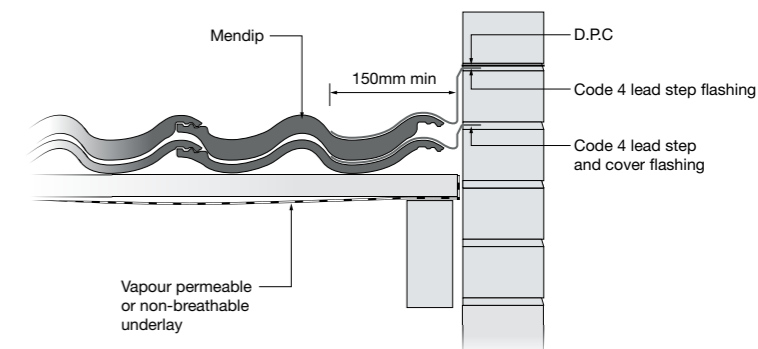

SIDE ABUTMENT WITH DRY FIX SOAKERS AND CONCRETE INTERLOCKING TILES

Suitable for Modern, Edgemere, Ashmore, Plain concrete tiles and clay plain tiles. Vapour permeable underlay shown.

- ▲ for Modern and Edgemere: push fit the soakers on to the tiles and lay the tiles along the abutment in the normal manner
- ▲ for concrete or clay plain tiles: soakers are laid on top of each
- ▲ for Ashmore: install tile soakers with the 90° turn-down locating over the rear of the tiling battens – beneath each tile

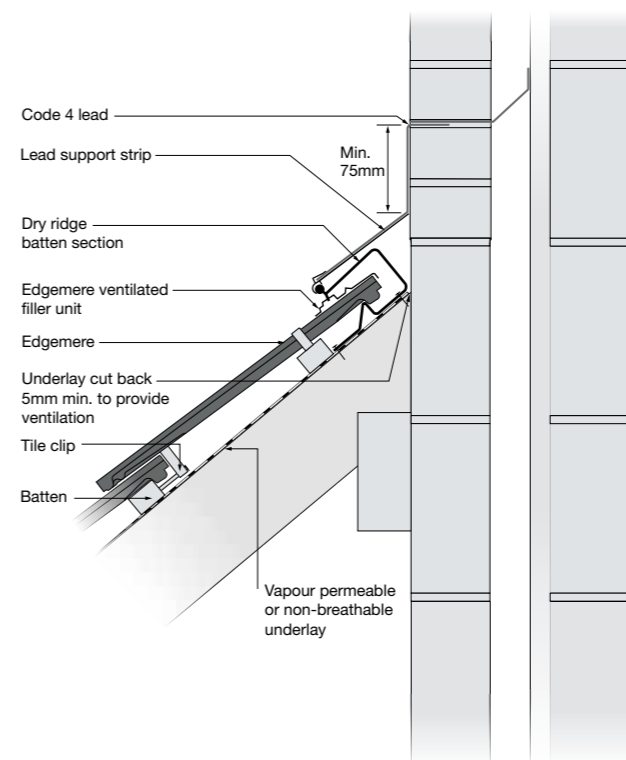

TOP ABUTMENT VENTILATION WITH CONCRETE INTERLOCKING SLATES

Suitable for all concrete tiles and slates.

- ▲ maximum rafter pitch 45° (55° using steep pitch batten section)
- ▲ provides 5,000mm²/lin.m ventilation
- ▲ ensure air passage from roof void is not obstructed
- ▲ mechanically fix all top course tiles
- ▲ use minimum 1.5m length of lead flashing with 150mm side laps

For length of top abutment flashing over tile, please see page 179.

Specification toolkit

Marley provides a comprehensive technical service and a range of online tools to ensure design performance and compliance to the latest Building Regulations and NHBC Technical Standards.

- ▲ Fixing specifications
- ▲ NBS clauses
- ▲ CAD details
- ▲ BIM models

Visit marley.co.uk/specifying



FLEXFAST LEAD REPLACEMENT ROLL WITH INTERLOCKING TILES

Suitable for all clay, concrete and other tiles and slates

- ▲ Lightweight and easy-to-install replacement for lead
- ▲ Easy to shape and cut to suit wide range of side, top and chimney abutments
- ▲ Flexfast material is up to 60% stretchable and has excellent adhesion properties

For length of top abutment flashing over tile, please see page 179.



Roof slopes

The roof slope offers the designer an opportunity to allow the passage of light and ventilation to the interior of the building. This can be achieved by numerous details in the form of dormers and roof lights or ventilation terminals and pipes.

Roof lights should be located well away from chimneys or flues, roof valleys and hips, or other details, which might interrupt the effective drainage of the roof slope. Ventilation terminals located in the roof slope should be spaced evenly in accordance with the free vent area of the terminal, and the requirements of the Building Regulations.

All pipes and terminals that project through the roof tiling should be suitably weathered with a lead flashing, which fits tightly around the pipe and dresses over adjacent tiles.

SELECTED ROOF SLOPE DETAILS

UNIVERSAL TILE VENT TERMINAL WITH CONCRETE INTERLOCKING TILES

Suitable for all large format and '15 x 9' interlocking tiles. Vapour permeable underlay shown.

- ▲ locate clear of rafters
- ▲ use soaker tray to weather hole in underlay
- ▲ locate at 3.0m centres for 5,000mm²/lin.m ventilation and 1.5m centres for 10,000mm²/lin.m ventilation
- ▲ suitable for roof space ventilation and mechanical extract and soil vent pipe
- ▲ use flexible pipe for connection to 110mm dia. pipework as termination to mechanical extract or soil vent pipe
- ▲ do not use as exhaust for hot flue gases
- ▲ when used as extract for soil vent pipes, keep minimum 900mm above any opening into building within 3m of vent terminal

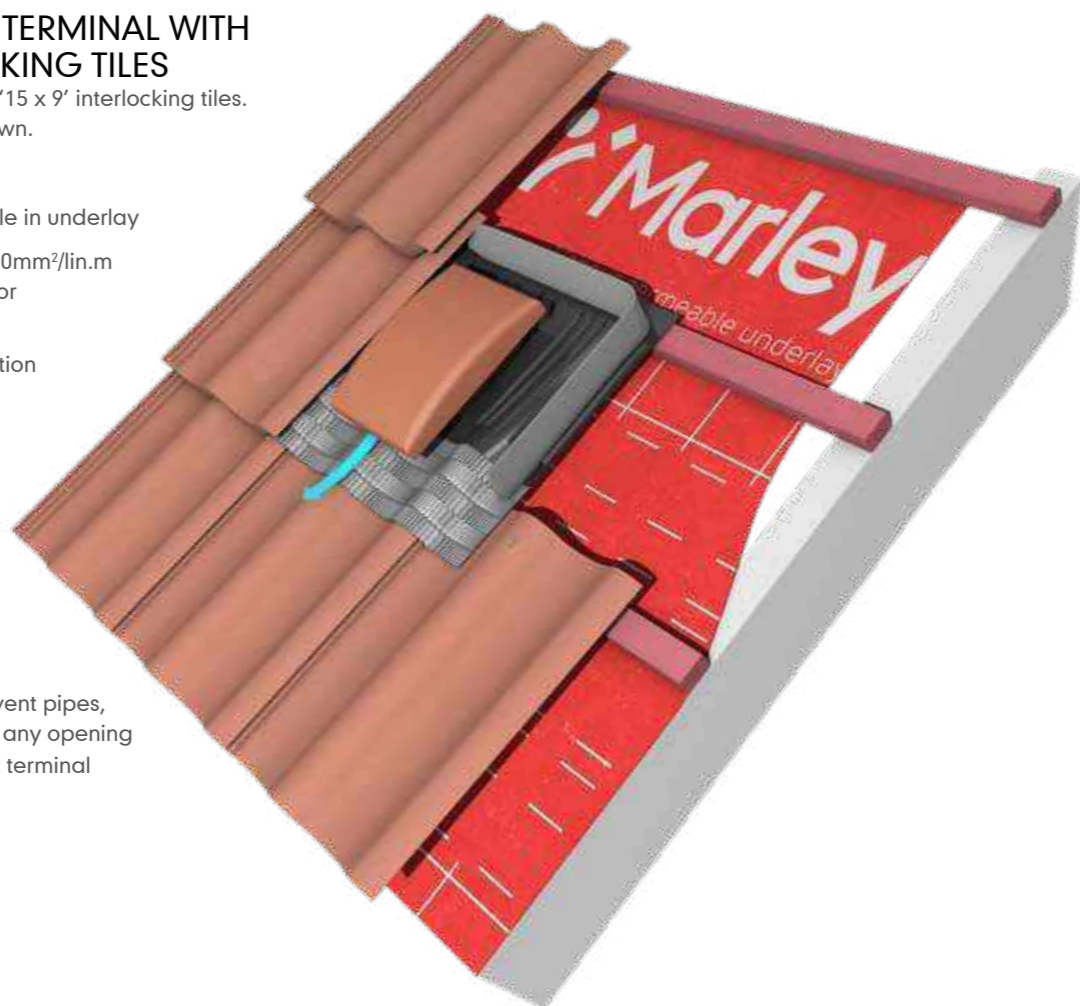

TILE VENT TERMINAL WITH INTERLOCKING SLATES (WARM ROOF)

Suitable for all concrete interlocking tiles and interlocking slates. Non-breathable underlay shown.

- ▲ locate clear of rafters
- ▲ use soaker tray to weather hole in underlay for spigot
- ▲ locate at 1.3-1.5m centres for 5,000mm²/lin.m ventilation and 565-765mm centres for 10,000mm²/lin.m ventilation

For mechanical extract/soil pipe termination

- ▲ use flexible pipe for connection to 110mm dia. pipework as termination to mechanical extract or soil vent pipe
- ▲ do not use as exhaust for hot flue gases
- ▲ when used as extract for soil vent pipes, keep minimum 900mm above any opening into building within 3m of vent terminal

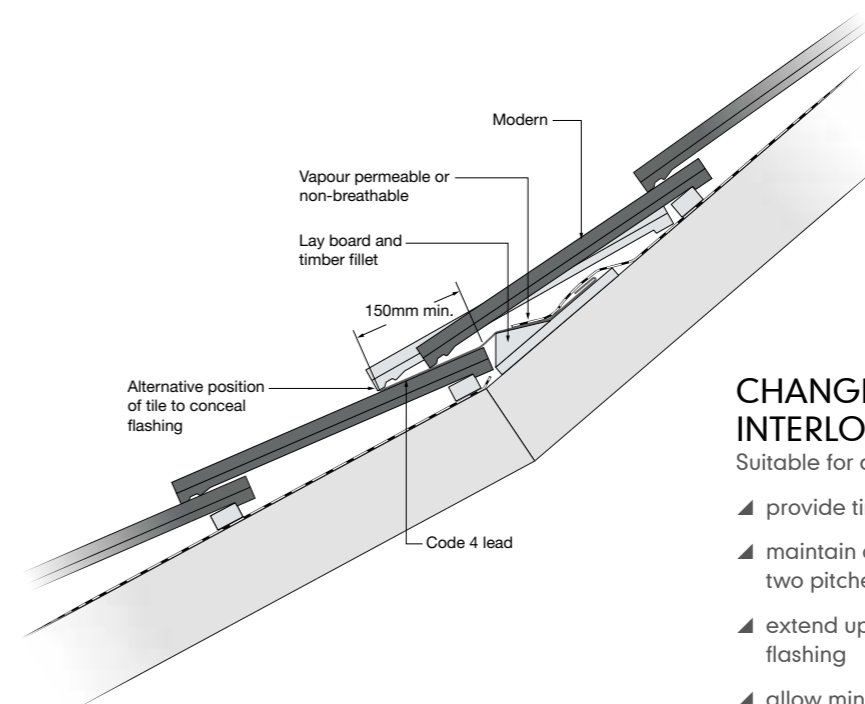
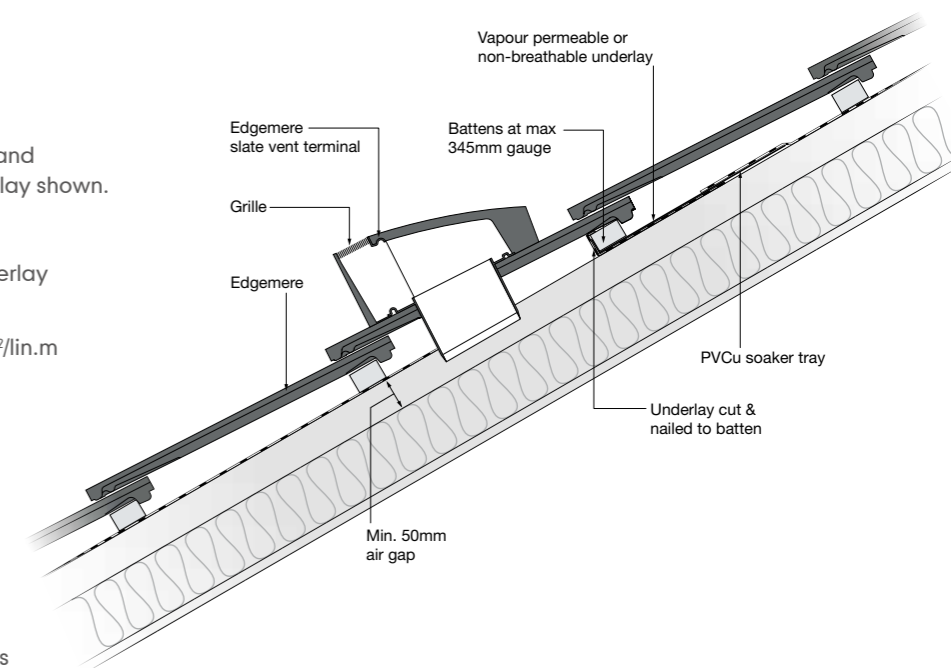

CHANGE OF PITCH WITH INTERLOCKING TILES

Suitable for all concrete and clay interlocking tiles.

- ▲ provide timber lay board and fillet for lead flashing
- ▲ maintain continuous lap of underlay at junction of two pitches
- ▲ extend upper course of tiles over lead to conceal flashing
- ▲ allow minimum 150mm lap of flashing onto lower course of tiles



Specification toolkit

Marley provides a comprehensive technical service and a range of online tools to ensure design performance and compliance to the latest Building Regulations and NHBC Technical Standards.

- ▲ Fixing specifications
- ▲ NBS clauses
- ▲ CAD details
- ▲ BIM models

Visit marley.co.uk/specifying

SELECTED ROOF SLOPE DETAILS

IN-LINE VENT TERMINAL WITH CLAY PLAIN TILES (COLD ROOF)

Suitable for all clay plain tiles. Vapour permeable underlay shown.

- ▲ locate clear of rafters
- ▲ use soaker tray to weather hole in underlay for spigot
- ▲ locate at 1.22m centres for 5,000mm²/lin.m ventilation and 0.61m centres for 10,000mm²/lin.m ventilation

For mechanical extract/soil pipe termination

- ▲ use tile vent adaptor for connection to 110mm dia. (ID) pipework as termination to mechanical extract or soil vent pipe
- ▲ do not use as exhaust for hot flue gases
- ▲ when used as extract for soil vent pipes, keep minimum 900mm above any opening into building within 3m of vent terminal



Specification toolkit

Marley provides a comprehensive technical service and a range of online tools to ensure design performance and compliance to the latest Building Regulations and NHBC Technical Standards.

- ▲ Fixing specifications
- ▲ NBS clauses
- ▲ CAD details
- ▲ BIM models

Visit [marley.co.uk/specifying](https://www.marley.co.uk/specifying)



Special details

Due to their small format, most slates and plain tiles are well suited to forming a variety of special details ranging from the more traditional 'Winchester' and 'Sussex' gable ends to the more complex curved roof geometries associated with eyebrow and curved roofs, mansard and roof slope junctions.

In addition, the designer now has a wide choice of rigid under-tile or slate systems, which have advantages in providing better thermal efficiency and weathertightness of the roof system, but require special consideration when detailing the tile or slate covering.

Pages 176-178 show a small selection of special details using Marley products and accessories and are offered for guidance only. Other similar details may prove equally satisfactory.

In all cases, the design team should satisfy themselves that the details finally selected are appropriate to the specific application, and adequate for the site and its degree of exposure.

Please note that these pages are intended for the use of designers, and therefore do not include full fixing information. Those requiring guidance on fixing tiles and slates should refer to our range of sitework and fixing guides.



SELECTED SPECIAL DETAILS

VERTICAL TILING

VERTICAL TILING WITH PLAIN TILES

Plain tiling is an excellent, weatherproof and attractive cladding to the vertical walls of any building. Feature and ornamental tiles may also be used with normal plain tiles to create decorative patterns.

- ▲ use counterbattens over masonry construction (38mm x 25mm minimum) to reduce direct fixing. Special masonry fixings may be required
- ▲ ensure tiling details do not interfere with the opening of windows and doors
- ▲ lead flashings and soakers should be used around openings in accordance with Lead Sheet Association details
- ▲ use double course of tiles at eaves, by laying first course of eaves/tops tiles with course of full tiles over
- ▲ at top of wall or under a sill, use a course of eaves/tops tile laid over a course of full tiles. Dress a Code 4 lead cover flashing over by 100mm
- ▲ use internal and external angle tiles at all 90° corners. Purpose made 135° angle tiles are also available. For other angles, close mitre tiles and use Code 3 lead soakers
- ▲ all tiles should be twice nailed

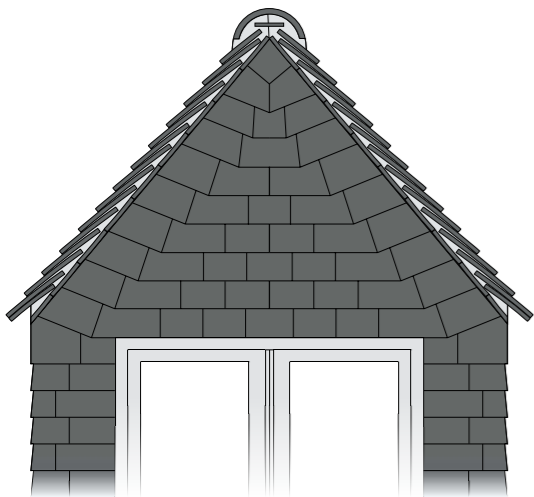

WINCHESTER CUT WITH PLAIN TILES

This gable end detail may be used for both concrete and clay plain tiles, and avoids the use of small triangular pieces of tile by providing a secure fixing of a tile-and-a-half against the rake of the gable.

- ▲ best suited for roof pitches of 40° and above
- ▲ fix batten parallel with rake of verge and level with vertical tiling battens
- ▲ use tile-and-a-half at end of each course and cut to rake (all tiles should be of uniform cut)
- ▲ cut adjacent tile to raking cut tile-and-a-half
- ▲ use Code 3 lead soakers (200mm x 200mm) where side laps are less than 55mm
- ▲ at apex, use a tile-and-a-half turned through 45° and cut to shape

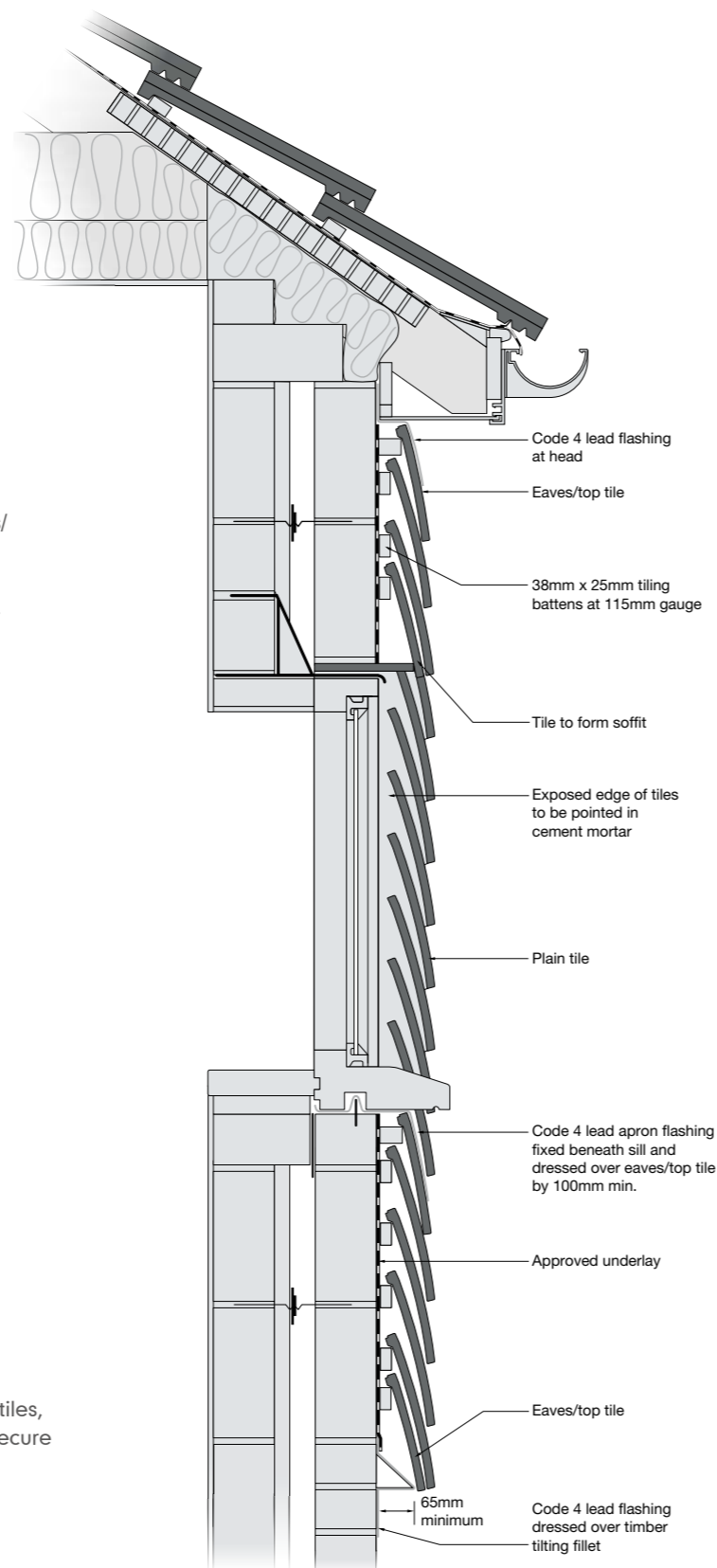

SELECTED SPECIAL DETAILS

RIGID SARKING

Roofing practice in Scotland includes the use of timber sarking and counterbattens. With the growing trend towards the use of insulated boards as a rigid sarking in habitable roofs, many of the standard roof details will be affected by the increase in thickness of the layer of the roof assembly.

Of particular concern is the design of the counterbatten and batten fixings, which often require special proprietary fixings capable of providing adequate withdrawal resistance through the insulation and into the rafter (see Annex B of BS 5534).

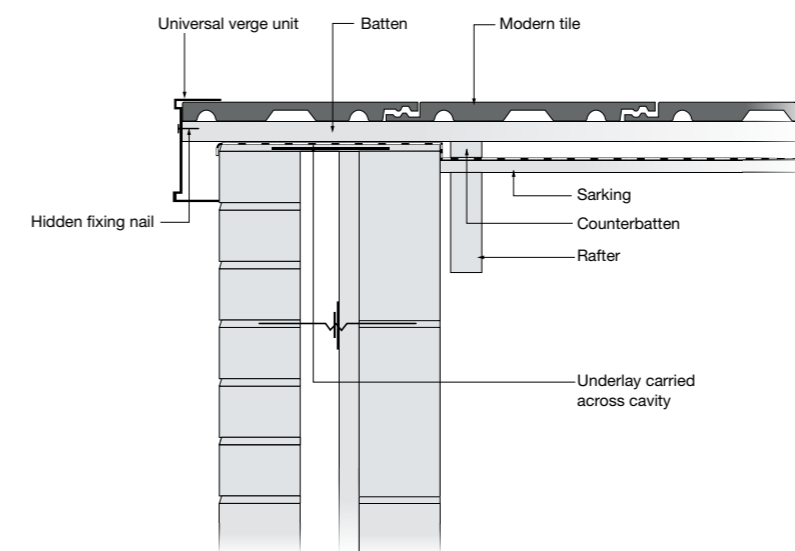

UNIVERSAL DRY VERGE DETAIL WITH INTERLOCKING SLATES

Suitable for all interlocking concrete tiles. A separate verge unit is available for Edgemere and Duo Edgemere. Vapour permeable (shown) or non-breathable underlay can be used.

- ▲ maximum rafter pitch 45° (55° when used with Steep Pitch Dry Ridge)
- ▲ top of outer and inner leaves of masonry should be level with top of counterbattens to allow battens to extend across

Specification toolkit

Marley provides a comprehensive technical service and a range of online tools to ensure design performance and compliance to the latest Building Regulations and NHBC Technical Standards.

- ▲ Fixing specifications
- ▲ NBS clauses
- ▲ CAD details
- ▲ BIM models

Visit marley.co.uk/specifying

- ▲ allow for extra thickness of any external render or roughcast to outer leaf of masonry. Certain types of finish will require a timber board to facilitate a level surface for the dry verge units
- ▲ extend tiling battens 45mm over edge of render or roughcast
- ▲ nail each verge unit to ends of tiling battens
- ▲ finish apex with PVC ridge end cap
- ▲ mechanically fix all verge tiles

SELECTED SPECIAL DETAILS

RIGID SARKING

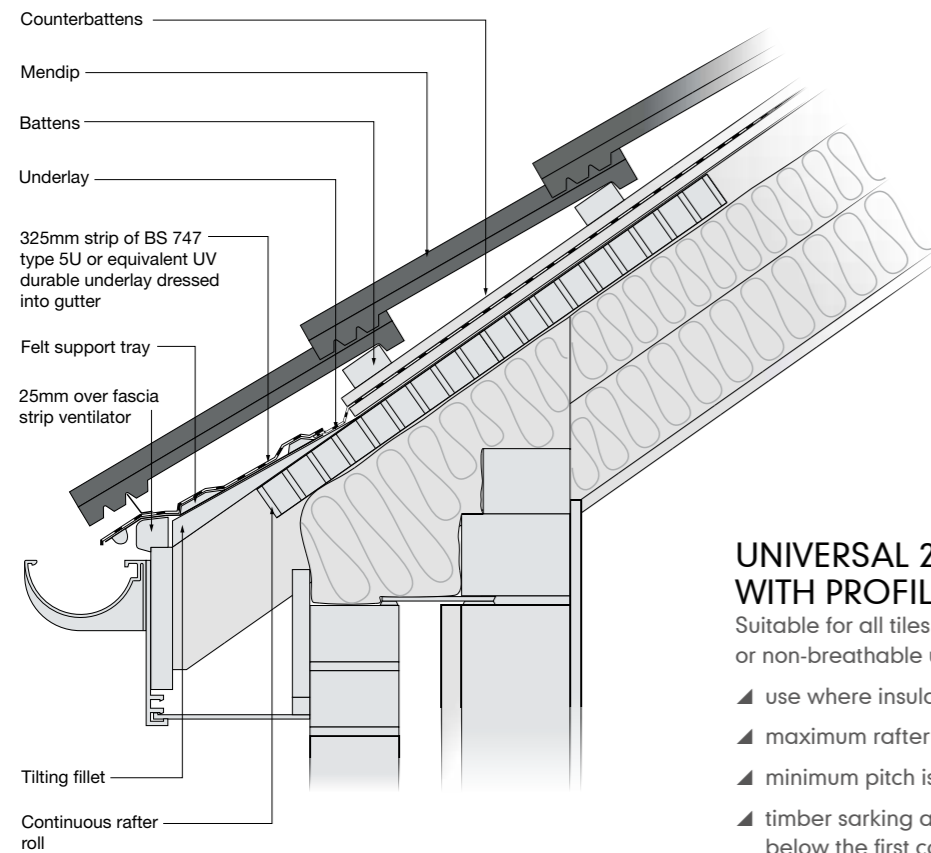

UNIVERSAL 25MM EAVES VENT SYSTEM WITH PROFILED INTERLOCKING TILES

Suitable for all tiles and slates. Vapour permeable (shown) or non-breathable underlay can be used.

- ▲ use where insulation follows the line of the rafter
- ▲ maximum rafter pitch is 55°
- ▲ minimum pitch is 15° (dependent on tile profile)
- ▲ timber sarking and counterbattens should terminate just below the first course batten and directly behind the top edge of the underlay support tray
- ▲ suitable for use with or without soffit
- ▲ ensure fascia board is to correct height so as not to cause eaves course tiles to either tilt or droop. Height above rafter will vary with rafter pitch and allowance should be made for the thickness of the sarking and counterbattens
- ▲ use additional rafter trays to bridge extra thickness of insulation so as to maintain ventilation path
- ▲ mechanically fix all eaves course tiles and use a comb filler strip with deeply profiled tiles

PITCH AND ANGLE TABLES FOR HIPS, VALLEYS, RIDGES AND ABUTMENTS

TABLE 1: RELATIONSHIP OF ROOF PITCH TO INTERNAL ANGLE OF HIP – PLAIN TILE ROOF

Known roof pitch	Internal angles of hip tile
20-25°	–
30°	145°
35°	145°
37.5°	140°
40°	135°
42.5°	135°
45°	130°
47.5°	127°
50°	125°
52.5°	120°
55°	120°
57.5°	115°
60°	115°

TABLE 2: RELATIONSHIP OF ROOF PITCH TO VALLEY ANGLE – PLAIN TILE ROOF

Known roof pitch	Internal angles of valley tile
30°	150°
35°	150°
37.5°	145°
40°	140°
42.5°	140°
45°	135°
50°	130°
52.5°	125°
55°	125°

TABLE 3: RELATIONSHIP OF ROOF PITCH TO INTERNAL ANGLE OF RIDGE TILES – PLAIN TILE ROOF

Known roof pitch	Internal angles of ridge tile
30°	115°
35°	105°
37.5°	105°
40°	105°
42.5°	90°
45°	90°
47.5°	90°
50°	90°
52.5°	75°
55°	75°
57.5°	75°
60°	75°

TABLE 4: RELATIONSHIP OF INTERNAL ANGLE OF RIDGE TILES TO ROOF – PLAIN TILE ROOF

Known internal angle of ridge tile	Plain tile roof pitch
75°	52.5-60°
90°	42.5-52.5°
105°	30-42.5°

TABLE 5: LENGTH OF TOP ABUTMENT FLASHING OVER TILE

Pitch	Length
15-17°	390mm
17.5-19.5°	350mm
20-22°	300mm
22.5-27°	250mm
27.5-34.5°	200mm
35-90°	150mm

TABLE 6: MIN. WIDTHS OF LEAD TO LINE VALLEY GUTTERS FOR DIFFERENT ROOF PITCHES/PLAN AREAS

Design rainfall rate	Roof area to be drained	
	25m ² and less on plan†	over 25m ² up to 100m ² on plan‡
12.5-17° roof pitch	550mm	650mm
17.5-22° roof pitch	525mm	600mm
22.5-29° roof pitch	500mm	550mm
30-34° roof pitch	500mm	525mm
>35° roof pitch	500mm	500mm

The performance and minimum design of valley pitch for proprietary valley products should be obtained from the Technical Advisory Service. The design rainfall rates and risk categories are summarised in BS EN 12056. For lead valleys, see also Volume 1 of the Lead Sheet Manual, published by the Lead Sheet Training Academy.

TABLE 7: MIN. WIDTHS OF LEAD VALLEY GUTTER* FOR DIFFERENT ROOF PITCHES/PLAN AREAS

Design rainfall rate	Roof area to be drained					
	25m ² and less on plan†	over 25m ² up to 100m ² on plan‡	25m ² and less on plan†	over 25m ² up to 100m ² on plan‡	25m ² and less on plan†	over 25m ² up to 100m ² on plan‡
12.5-17° roof pitch	150mm	250mm	125mm	200mm	125mm	150mm
17.5-22° roof pitch	125mm	200mm	125mm	150mm	100mm	125mm
22.5-29° roof pitch	100mm	150mm	100mm	125mm	100mm	100mm
30-34° roof pitch	100mm	125mm	100mm	100mm	100mm	100mm
>35° roof pitch	100mm	100mm	100mm	100mm	100mm	100mm

* Dimension A (see diagrams, left) is measured as a horizontal distance between the tiles or slates in millimetres.
 † The rafter lengths are equal to or less than 5m on plan.
 ‡ refer to BS 5534 6.1.1

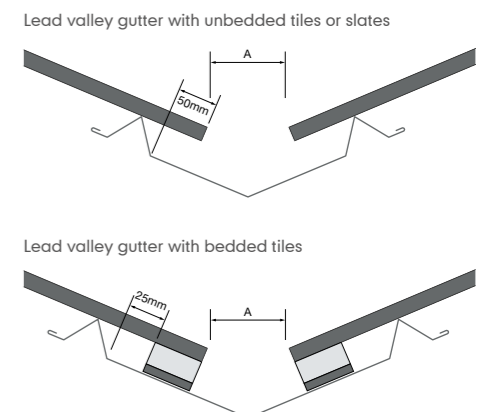

Specification toolkit

Marley provides a comprehensive technical service and a range of online tools to ensure design performance and compliance to the latest Building Regulations and NHBC Technical Standards.

- ▲ Fixing specifications
- ▲ NBS clauses
- ▲ CAD details
- ▲ BIM models

Visit marley.co.uk/specifying

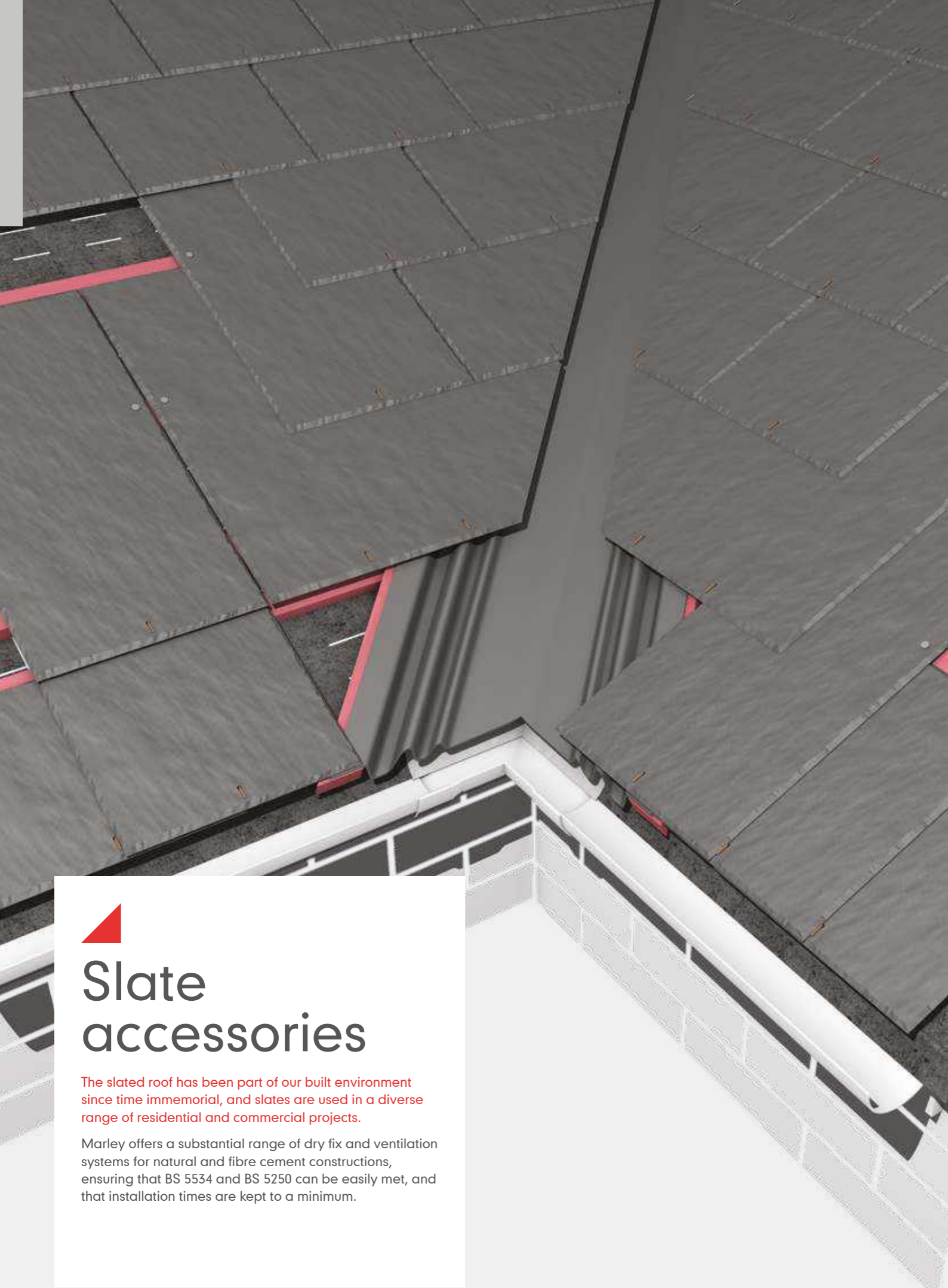

Slate accessories

The slated roof has been part of our built environment since time immemorial, and slates are used in a diverse range of residential and commercial projects.

Marley offers a substantial range of dry fix and ventilation systems for natural and fibre cement constructions, ensuring that BS 5534 and BS 5250 can be easily met, and that installation times are kept to a minimum.



SLATE DRY VERGE

Easy-to-install continuous dry fixed verge system, providing neat weatherproof and durable finish for slates.



DRY FIX SOAKERS

Ideal for roofs where the normal ventilation airpath is blocked by valleys, abutments, hips, dormer windows and firebreaks or party walls or where it is not possible to incorporate standard eaves or ridge ventilation



IN-LINE SLATE VENTILATOR

Ideal for roofs where the normal ventilation airpath is blocked by valleys, abutments, hips, dormer windows and firebreaks or party walls or where it is not possible to incorporate standard eaves or ridge ventilation



SLATE DRY VALLEY

Developed to allow the designer freedom to specify a completely mortar-free roof, this system utilises the latest GRP technology. The advanced and unique parabolic gutter section improves discharge rates without added gutter depth.

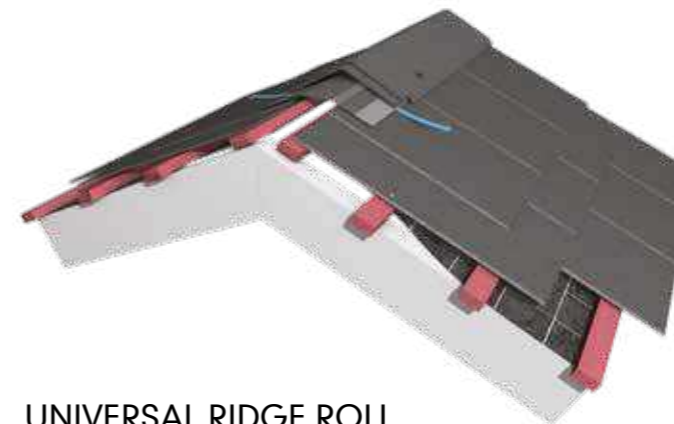

UNIVERSAL RIDGE ROLL

Simple and rapidly installed dry fix system providing 5mm continuous ridge ventilation. Compatible with fibre cement slates and ridges.

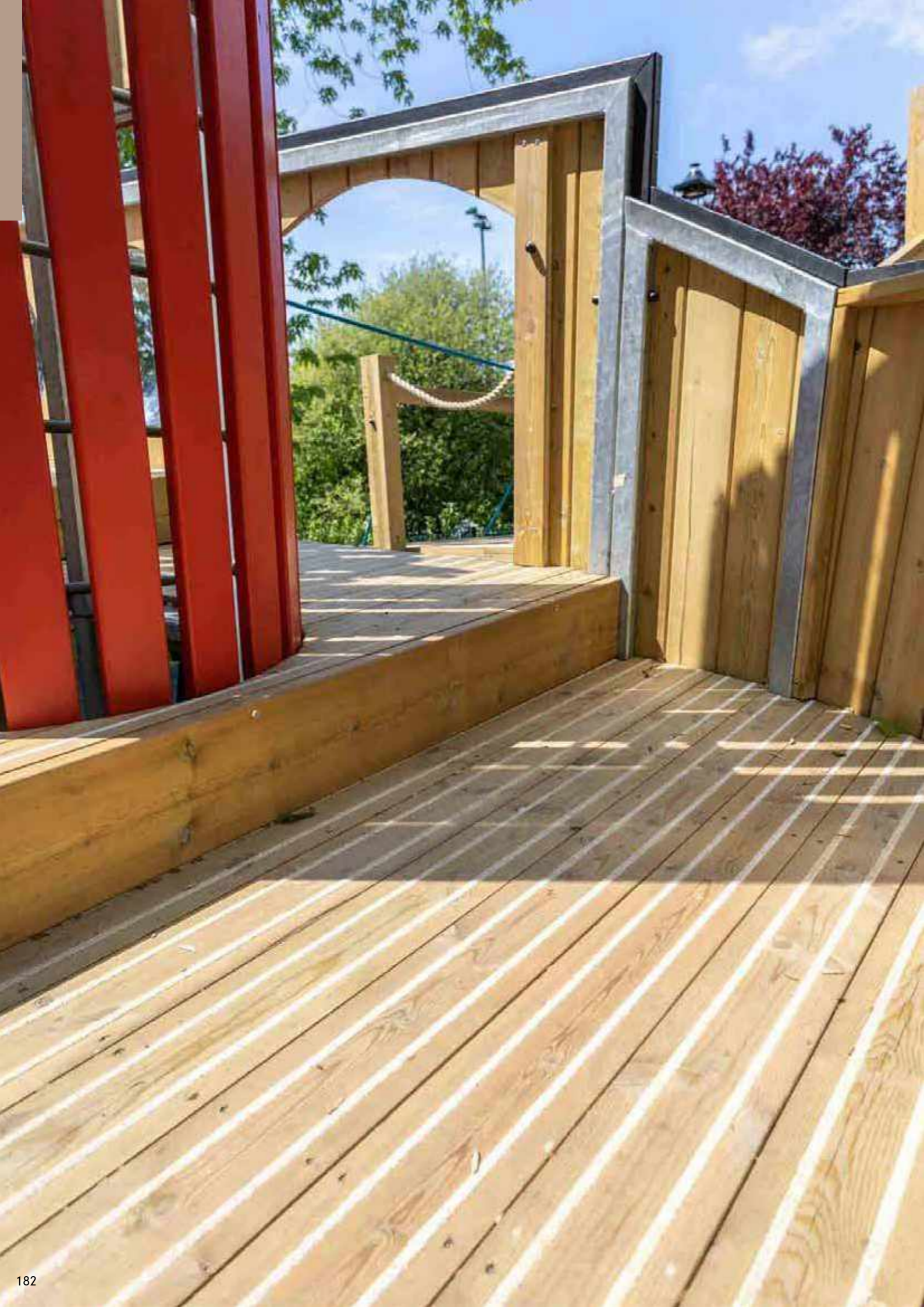

Decking

WHY CHOOSE ANTISLIP DECKING? 184
CITIDECK® 186
OTHER DECKING OPTIONS 188

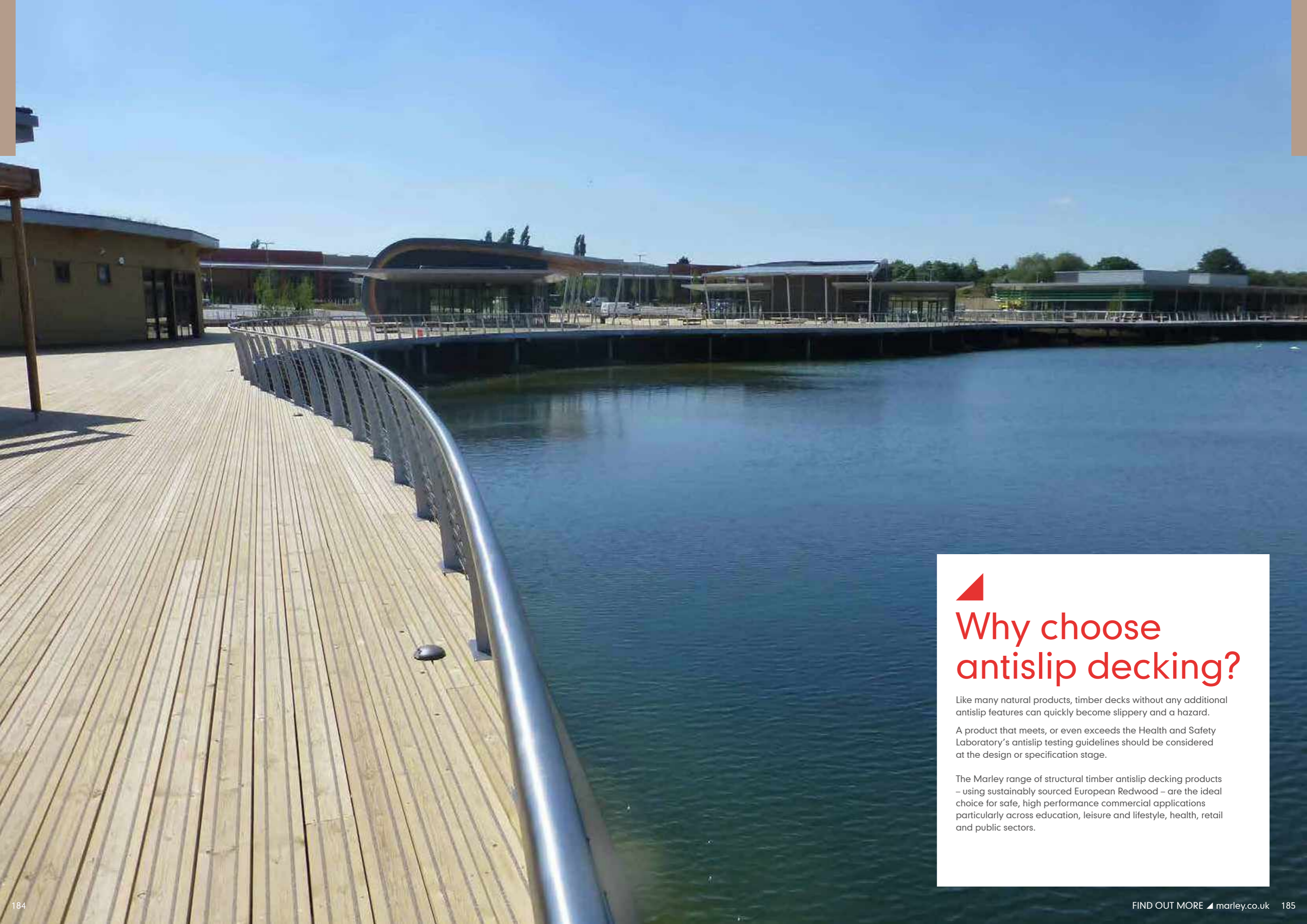

Why choose antislip decking?

Like many natural products, timber decks without any additional antislip features can quickly become slippery and a hazard.

A product that meets, or even exceeds the Health and Safety Laboratory's antislip testing guidelines should be considered at the design or specification stage.

The Marley range of structural timber antislip decking products – using sustainably sourced European Redwood – are the ideal choice for safe, high performance commercial applications particularly across education, leisure and lifestyle, health, retail and public sectors.

CITIDECK® FOR URBAN ENVIRONMENTS



When specifying decking for outdoor areas, consideration must be given to aesthetics, maintenance and safety. Choosing the right products, which are inclusive and safe, ensures areas are accessible and usable by everyone all year round.

Key factors when choosing products would be:

- ▲ Accessibility and inclusivity
- ▲ Sustainability
- ▲ Maintenance
- ▲ Strength
- ▲ Durability and treatment

CITIDECK®

CitiDeck timber deck boards have been specifically designed to provide a durable and effective external antislip surface to minimise the risk of slipping, even in adverse weather conditions.

CitiDeck is a smooth profile with 2 white flint inserts injected into the deck board grooves. The smooth profile and slightly less inserts used in CitiDeck ensures it is an ideal product for the urban environment and inclusive access.

BENEFITS

- ▲ A sustainable antislip timber decking for inclusive urban environments.
- ▲ Offers all the advantages of antislip timber decking but with a smooth profile, ideal for the urban environment and inclusive access.
- ▲ Uses a slightly less abrasive grit to provide a more even surface for wheelchairs and the less able, whilst still exceeding the Health and Safety Laboratory's antislip testing guidelines.
- ▲ Features two antislip inserts in a white coloured flint. It is increasingly specified for the urban environment, including boardwalks, balconies, bridges, hotels, restaurants, pubs, retail outlets and offices.
- ▲ The smooth profile is easy to clean and its profile prevents the accumulation of dirt, litter and food waste.
- ▲ The most sustainable and one of the most environmentally friendly hard landscaping products.

TREATMENT

Marley timber decking is preservative treated to BS 8417:2011 Use Class 3 as standard*.

There are scenarios where decking will need to be treated to UC4 i.e. 'in contact with ground or fresh water, permanently exposed to wetting'. Marley can offer this level of treatment. For further information, please contact the Technical Advisory Service.

Any surface exposed by cutting must be treated with a cut end seal.

* External out of ground contact, exposed to weather.



FIXINGS

When working with preserved timber, it is important to use the right type of fixings. To ensure optimum performance, Marley offer a range of deck screws.

TECHNICAL DATA

Profile	Smooth	
Grade	C16 C24	
Slip potential (Pendulum test value)	Low 61-73 PTV (dependent on wet or dry surface)	
Preservative treatment	Use Class 3 (to BS 8417) Use Class 4 Naturewood treatment (available on request)	
Timber	Kiln dried Vths European Redwood FSC and PEFC certified with full chain of custody	
Inserts	2 no. white flint inserts	
Compliance	BS 4978 BS 7976 UKCA and CE marked	
Accreditation	TDCA Deckmark Plus	
Fixing	316 grade stainless steel deck screws	
Dimensions	Finished (mm)	Lengths (m)*
	28 x 120	Special order
	28 x 145	3.6, 4.2, 4.5, 4.8
	34 x 120	Special order
	34 x 145	3.6, 4.2, 4.5, 4.8
46 x 145	Special order	
68 x 145	Special order	

* Precision end trimming to customer specification is available.



OTHER DECKING OPTIONS

We use sustainably sourced European Redwood as the optimum timber choice for our decking range due to its strength and stability. With the treatment options we offer and by following our guidance on care and maintenance we provide a strong, durable and hardwearing decking range which offers a long service life.

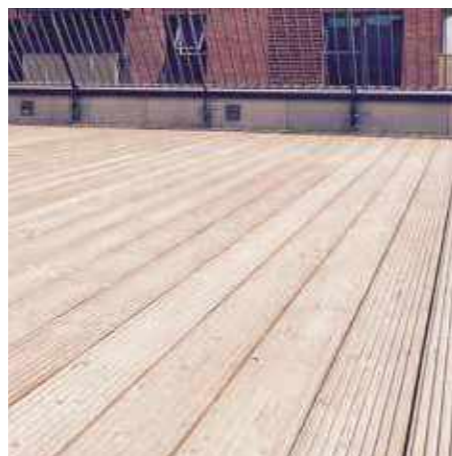

MARLEY ANTISLIP®

Developed specifically to provide a slip resistant exterior surface. Recommended for all commercial applications and where there is public access. Both castellated and smooth boards are available.

MARLEY STANDARD

Standard deck boards are available in both castellated and smooth profiles; especially suitable for balcony decks or matching with Antislip Plus® or CitiDeck® in areas that don't require antislip boards.

TECHNICAL SPECIFICATION EXAMPLE GENERAL USE, BASED ON BS 5268

Assumptions

The assumptions used are the original ones that Marley derived from BS 6399: part 1 and are very similar to the assumptions made by the TDCA in their 'Timber decking – the Professionals Manual, edition 2' for commercial decks. These are a 5kN distributed load and a 1.4kN concentrated load with a mid span maximum deflection of 3mm. This deflection is derived from Approved Document M of Building Regulations so that there is a minimal chance of a trip hazard.

It must be noted that, unlike the Eurocode calculations, there is NO allowance for creep within these tables.

Eurocode span tables are available at: marleydecking.co.uk/Resources

Loads

- ▲ Assumptions: Marley
- ▲ Live load: 5kN/m²
- ▲ Point load: 1.4kN
- ▲ Max deflection: 3mm

Designed to BS 5268

Section: original size	Section: finished size	Profile/finish	C16 Multiple (span)	C24 Single (span)	C24 Multiple (span)
32 x 125mm	28 x 120mm	Castellated Smooth	240mm 300mm	290mm 350mm	350mm 430mm
32 x 150mm	28 x 145mm	Castellated Smooth	290mm 370mm	340mm 440mm	410mm 530mm
38 x 125mm	34 x 120mm	Castellated Smooth	380mm 450mm	450mm 530mm	540mm 640mm
38 x 150mm	34 x 145mm	Castellated Smooth	450mm 550mm	530mm 640mm	640mm 750mm
50 x 150mm	46 x 145mm	Castellated Smooth	890mm 950mm	880mm 920mm	980mm 1020mm
75 x 150mm	68 x 145mm	Castellated Smooth	1320mm 1410mm	1320mm 1360mm	1470mm 1520mm

Services & sustainability

THE POSITIVE SUSTAINABLE LOOP 190
ON HAND TO SUPPORT YOU 194

THE POSITIVE SUSTAINABLE LOOP

The issues of global warming, climate change and their effect on our environment are becoming increasingly important throughout the construction industry.

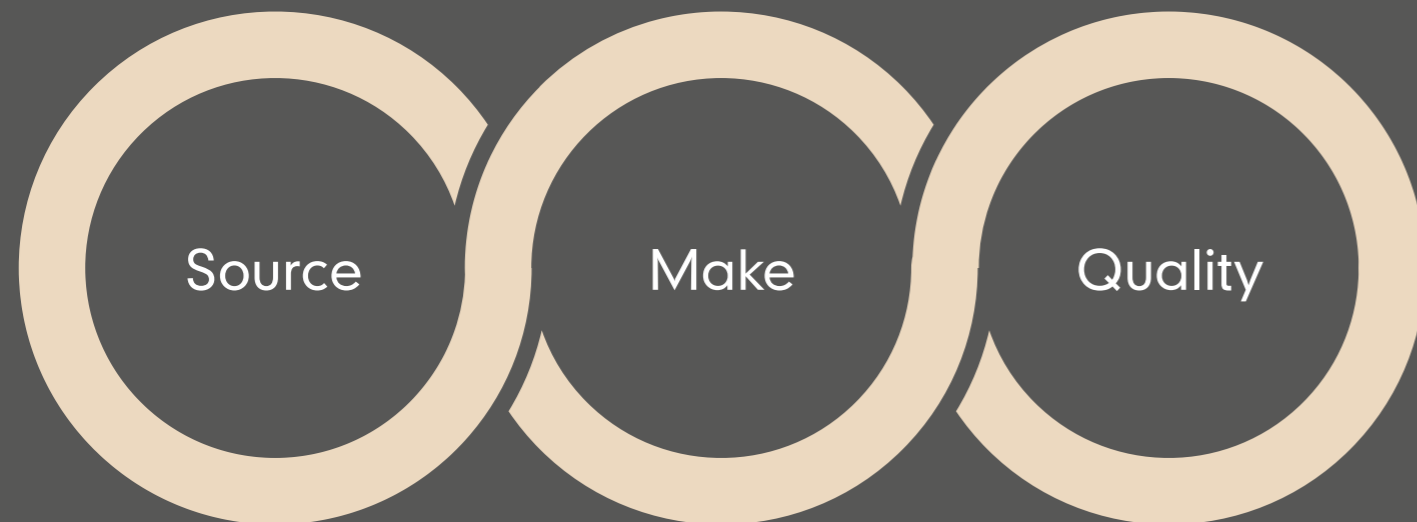

BES 6001 AND RESPONSIBLE SOURCING

Why this matters to us:

Raw materials and supply chains are sourced in a responsible manner.

Why this matters to you:

We are responsible. You can achieve better ratings when building sustainably.

MANUFACTURE AND CARBON REDUCTION

Why this matters to us:

Lower energy, lower carbon, reduced manufacturing waste.

Why this matters to you:

Lower embodied energy products, with excellent performance, achieving higher ratings.

PRODUCTS THAT ADD FUNCTION AND SUSTAINABILITY

Why this matters to us:

Integrated product systems with specifiable environmental benefits.

Why this matters to you:

Durable, high-functioning solutions with better BREEAM and Code for Sustainable Homes credits.

At Marley, we believe in creating a positive spiral of sustainability that helps our customers and suppliers to put environmental best practice at the top of the agenda.

We already have an outstanding track record of sustainable success. Marley was the first in the roofing industry to have LCA (Life Cycle Assessment) data verified and to be awarded Certified Environmental Profiles by BRE (Building Research Establishment); and the first to be awarded ISO 14001 – the internationally recognised standard for environmental management systems – at all our factories.

Our holistic approach to sourcing, manufacturing and health and safety has led to a 'good' accreditation to BS 6001 Responsible Sourcing of Construction Products for our UK manufactured ranges. This in turn, can mean credits in BREEAM and The Code for Sustainable Homes for the specifiers of our products.

Every Marley site in the UK is constantly assessed and training needs for staff are identified and met.

Manufacturing processes are constantly reviewed to minimise their environmental impact and each year we actively look for ways to improve our procedures and reduce our environmental impact even further.

The key elements below outline some of the vital environmental and sustainable areas in which we are working and show how the pieces of the sustainability puzzle create an integrated whole.

Of course, sustainability is a complex and fast-moving subject, and we keep the very latest information updated on our comprehensive website at all times.

marley.co.uk/sustainability

SOURCE ∞∞

Where possible and practicable, the business attempts to use raw materials and suppliers with sources local to our production facilities.

- ▲ BES 6001 'Excellent' rating
- ▲ FSC and PEFC certified timber with full chain of custody

Assessment and certification to the BES 6001 standard continues to raise the business's profile within the industry, and provides credible third-party verification of efforts to positively manage the impact of the organisation.

A long-term commitment to the life cycle assessment of products, including current embodied carbon ratings, continues to set the business apart from industry competitors. It also allows customers to make more informed decisions based on the 'cradle-to-grave' impact of each product.

As an industry leader, the business has demonstrated continued commitment to innovation by putting it at the heart of the business. The development of affordable, innovative and sustainable products, that benefit customers and the wider environment is a priority.





MAKE

Carbon emissions

Marley is committed to maintaining a sustainable environment and minimising the carbon impact of its operations.

- ▲ BES 6001 'Excellent' rating
- ▲ Renewable materials
- ▲ Reuse own waste raw material
- ▲ Increase recycled and recyclable materials

All of our roofing products have a calculated carbon footprint rating. The provision of this data enables greater transparency of environmental impacts associated with our products, helping to facilitate a more informed and responsible product choice.

The business has a long-term commitment to having its products 'life cycle assessed' for the purpose of producing comprehensive Environmental Product Declarations (EPDs). Such declarations provide verified impact data, including embodied carbon, which can be used as a basis of continual environmental improvement.

Marley also has commitments and obligations under the various Government climate change and energy reduction regulations, including the Carbon Reduction Commitment Energy Efficiency Scheme (CRC), the European Emissions Trading Scheme (EUETS) and Energy Savings Opportunity Scheme (ESOS).

Resource use

Switching to more environmentally friendly and sustainable constituent materials is a high priority for the business, and wherever reasonably practicable, the company will endeavour to:

- ▲ Use fewer materials
- ▲ Use renewable materials
- ▲ Reuse own waste raw material
- ▲ Increase recycled and recyclable materials
- ▲ Reduce water consumption

Concrete tiles

Concrete tiles, produced at our Burton and Beenham factories, continue to increase the amount of recycled and crushed aggregate replacement. All crushed waste is analysed before being added back to the process for particle analysis to ensure the material meets specifications to continue to provide optimal tile performance and strength properties.

Clay tiles

In addition to strict supply chain management, 100% of unfired clay waste is introduced back into the production process which minimizes waste and maximizes the use of the raw material.

Marley works very closely with suppliers of raw materials to continually identify opportunities for improvement to reduce the waste volumes generated and increase recycling / re-use options. Where possible, Marley aims to source all raw materials locally to the manufacturing locations to minimise transport emissions.

Water

The business is fully aware that water is a natural and often scarce resource that needs to be conserved. Consequently, all of our sites have ambitious targets to reduce water consumption year-on-year.

In order to achieve an ongoing reduction in water usage, factories are required to assess their own processes and explore all options, specific to their location, for the potential reduction of water use. Consequently, a number of our production sites have succeeded in introducing innovative ways of recycling wastewater which is fed back into the production process – creating a closed cycle.

Our clay tile factory at Keele continues to be exemplar in its efforts to manage its water usage – and has introduced a rainwater harvesting system that collects, stores and uses rainwater, reducing demand on mains supplies.

Waste management

We continue to achieve 100% recycling of production waste, most of which is reprocessed and fed back into the production cycle with the remainder diverted and recycled for other uses, such as a sub-base for road construction.

Marley recognises that the ideal solution is not to produce waste at all – all of our sites are tasked with implementing rigorous controls and procedures to mitigate this. Waste segregation is driven to ensure we maximise the potential options for recycling to strive for 100% diverted from landfill.

Reducing transport impacts

As an industry leading manufacturer with national coverage, the business recognises the potential social and environmental impacts of all transport associated with its activities - including incoming raw materials and outgoing finished product.

In conjunction with raw material suppliers, and our contract haulier, the business has set strict targets to ensure that transport impacts are minimised at every level. This is achieved through effective route planning, local sourcing of materials, the optimisation of loads and the introduction of newer higher specification vehicles to the fleet.

QUALITY

All manufacturing plants have in place certified Quality, Health and Safety and Environmental management systems, to the internationally-recognised ISO 9001, ISO 14001 and OHSAS 18001 standards.

We have adopted BES 6001 Framework Standard for the Responsible Sourcing of Construction Products. This is recognised across the industry as a means of demonstrating the highest levels of sustainability and responsibility.

Annual audits provide the business with a certification and rating across all product groups – an increasingly important means of demonstrating commitment to CSR. Certification also enables construction professionals to achieve higher environmental levels on building designs, built to the Code for Sustainable Homes, or BREEAM.





On hand to support you.

Marley are committed to ensuring that our roof systems meet and exceed ever-changing and rigorous guidelines, regulations and standards.

With the ability to offer more integrated roofing elements than any other manufacturer, no one is better placed to design out roofing problems and 'design in' high performance.

This gives you more control, more flexibility and total assurance that the installed roof is a complete and integrated solution that exactly meets the needs of your project.

We are here and happy to help support you with your designs and specifications.

tel 01283 722588

email roofing@marley.co.uk

visit marley.co.uk

SOME KEY AREAS WHERE WE CAN HELP

BS 5534: Gives recommendations for the design, materials, application, installation and performance of slates and tiles.

BS 8612: Premium quality dry fix and ventilation systems that meet or exceed the six quality and performance criteria set out in BS 8612.

BS 5250: Control of harmful condensation is given in British Standard BS 5250: 'Code of practice for control of condensation in buildings'.

Responsible Sourcing: Responsible Sourcing of Construction Products is demonstrated through an ethos of supply chain management and product stewardship.

BREEAM: The world's foremost environmental assessment method and rating system for buildings.

Building Regulations: Provide practical guidance for some of the common building situations in respect of the requirements for materials and workmanship.

Wind Loading: Building orientation, roof shape, pitch and many other factors can mitigate (or worsen) the effects of wind.

Topography: Specific local conditions can have a great influence on the suitability of types of roof covering and fixing specifications.

Airport Proximity: Roofs near airports can experience sudden and extreme wind load forces caused by trailing aircraft vortices.



▲ Samples

Seeing the real thing is vital to the specification process.

Take advantage of our next day sample service by visiting marley.co.uk/samples



▲ Technical advice

The best roofing systems and product solutions demand the best technical advice and back up. Our experience and knowledge are second to none.

Contact our Technical Advisory Team [01283 722558](tel:01283722558)



▲ National coverage

We have experts on hand across the country that understand the local vernacular and can help you design a bespoke roofing system for your project.

Find your local specialist by visiting marley.co.uk/contact-us



▲ CPDs

Our experts can deliver insightful CPD presentations at your premises and online, clearly unpicking and explaining a range of the latest pitched roofing issues.

Find out more about our RIBA accredited CPDs at marley.co.uk/cpd



Tell me more

Call 01283 722588

Email info@marley.co.uk

Or visit marley.co.uk

Marley, Lichfield Road, Branston, Burton upon Trent, DE14 3HD

