

INTR.  
SYSTEMS

ARCHITECTURAL GRILLES

# INTRAgrille T5060

- Walkways, platforms & staircases
- Architectural features
- Trench heating covers
- Service trench covers
- Entrance grilles
- Ventilation
- Light wells
- Drainage

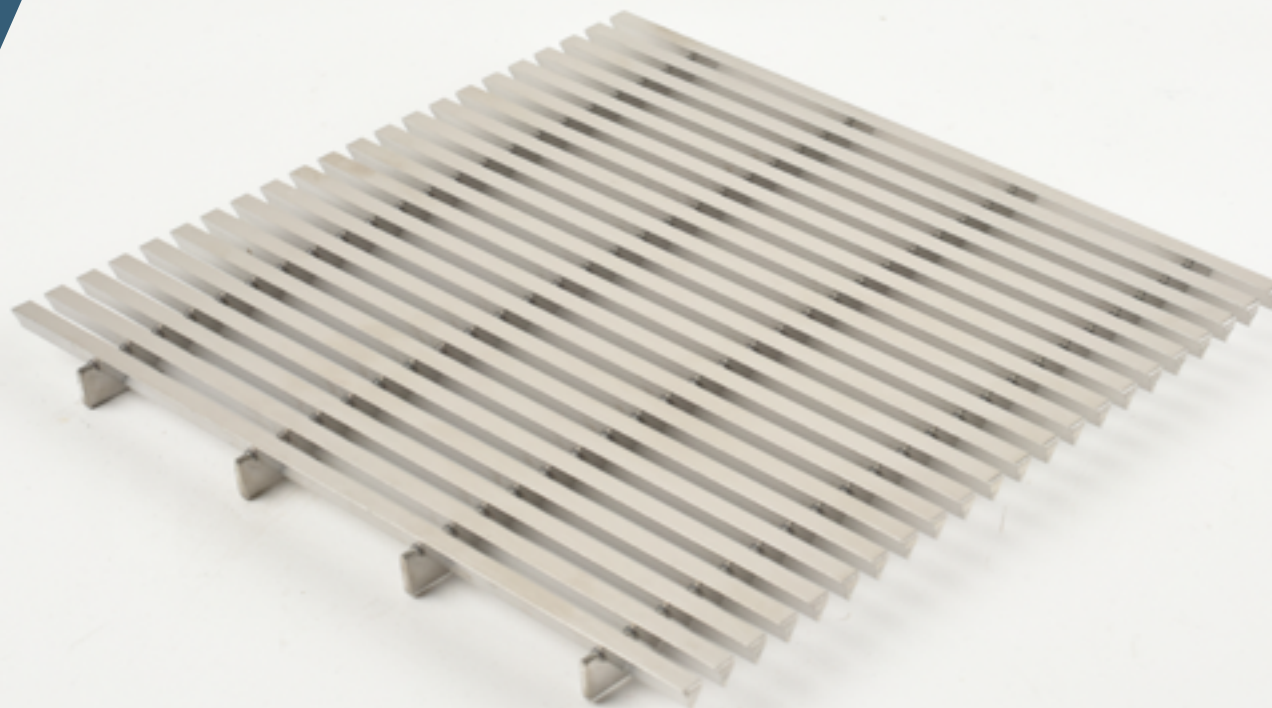

Product shown: INTRAgrille T5060 10x2 stainless steel

# PROFILE T5060

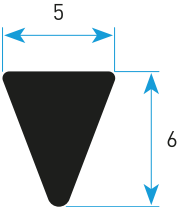
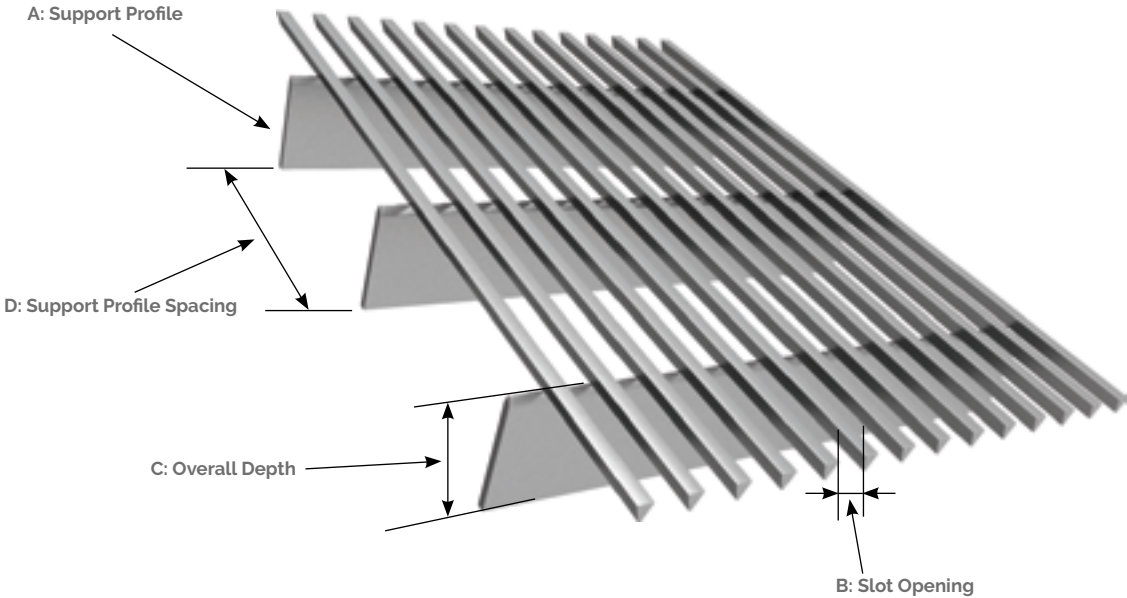

unit of measurement: [mm]  
scale: 2.5: 1

## SPECIFICATIONS

Product Reference:	INTRAGrille T5060
Support Profile:	10x2, 15x2, 20x2, 40x3
Support Profile spacing:	50mm (other options available)
Slot Opening:	>4mm constant, alternating or increasing (see pp26-27)
Open Area:	44% based on 4mm slot opening
Finish Options:	Pickled & Passivated, Electropolished, Powder Coated, Shot Peened

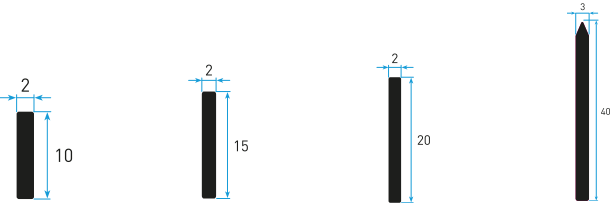

A	Support Profile	10 x 2	15 x 2	20 x 2	40 x 3
	Material	Stainless steel	Stainless steel	Stainless steel	Stainless steel
B	Slot Opening	4mm	4mm	4mm	4mm
C	Overall Depth	14.5mm	19.5mm	24.5mm	44.5mm
D	Support Profile Spacing	50mm	50mm	50mm	50mm
	Weight kg/m <sup>2</sup> *	19.0	20.6	22.2	35.0
	Typical max span**	300mm	500mm	650mm	1500mm

\* Based on 4mm slot opening  
\*\* For heavy pedestrian traffic

## FINISHES



Pickling & Passivation

Pickling - the most efficient and economical way to clean stainless steel surfaces of residuals that can lead to corrosion. Pickling improves the appearance of the surface: smoothing out scratches and sharp edges and removing stains from welding and cutting points.

Passivation - creates a thin oxide layer on the surface to increase resistance to chemical agents and passivity to weather conditions.



Powder Coating

Powder coating is the process of applying particles of powder paint to the surface of carbon steel to provide a coating that is resistant to corrosion, chemicals, heat and mechanical damage. Coatings can be made in **any RAL colour**. Special paint finishes are also available including certified antibacterial and abrasion resistant.



Electropolishing

Electropolishing is used to smooth and polish the surface of stainless steel and provide additional protection against corrosion. The process improves the aesthetic appearance and makes the finished product easier to keep clean.



Shot Peening

Shot Peening involves bombarding the surface of stainless steel with steel or glass balls to achieve different degrees of slip resistance.

# FIXINGS

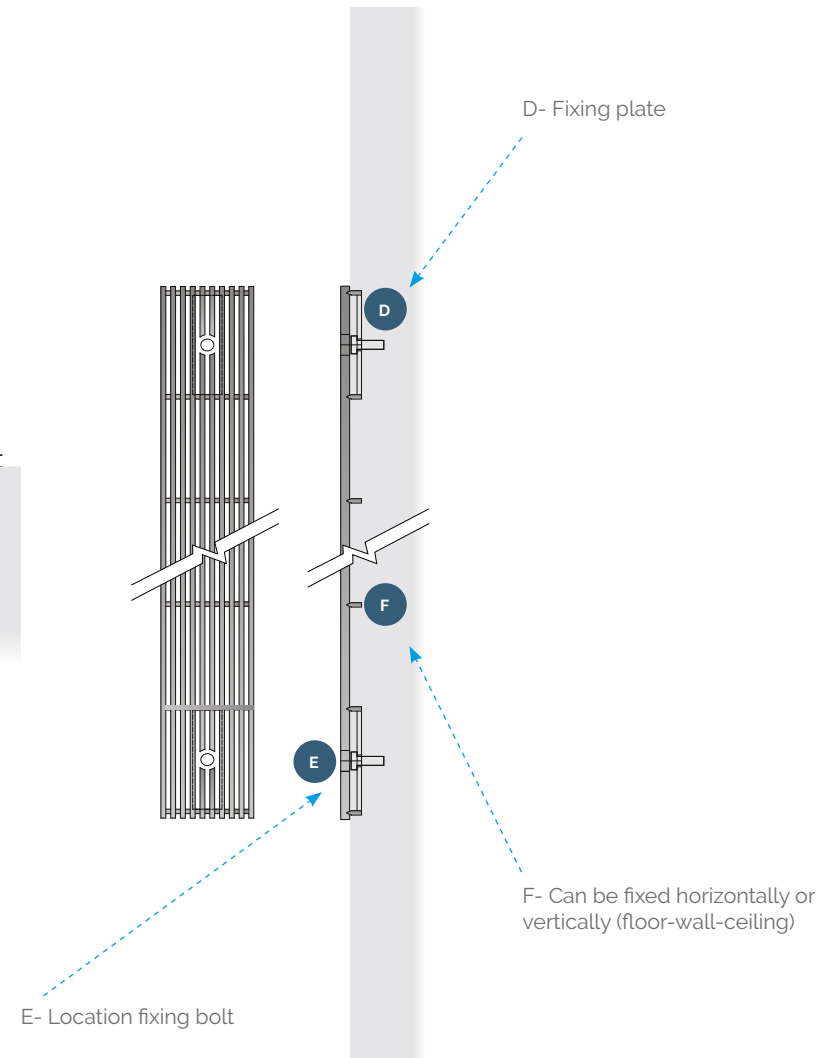
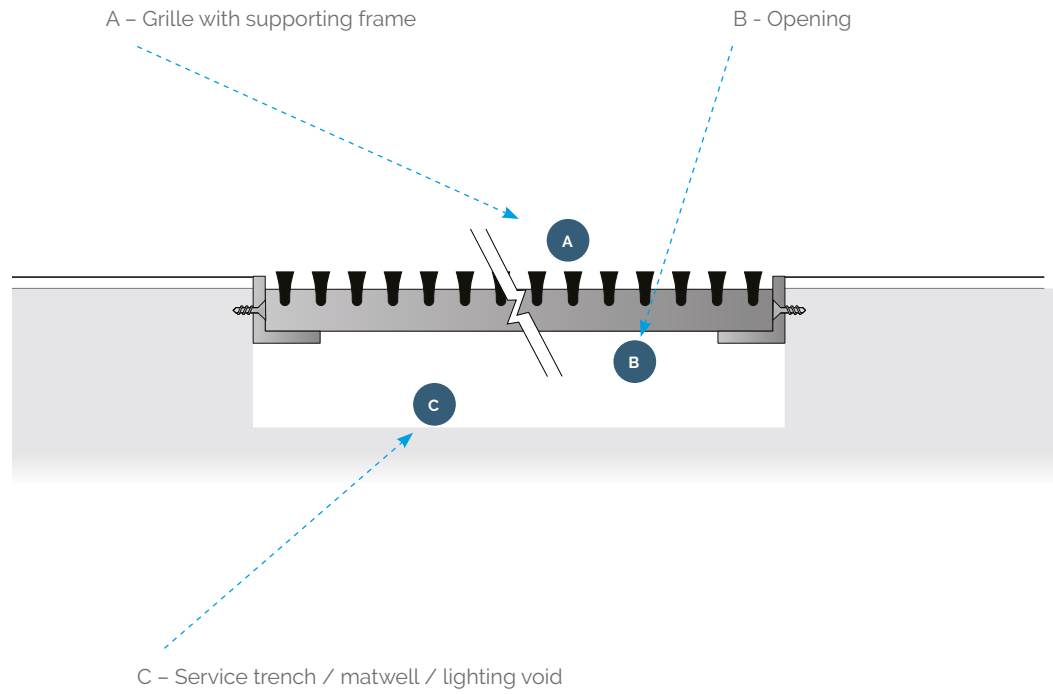

*Hinged, framed and bespoke fixings available.*

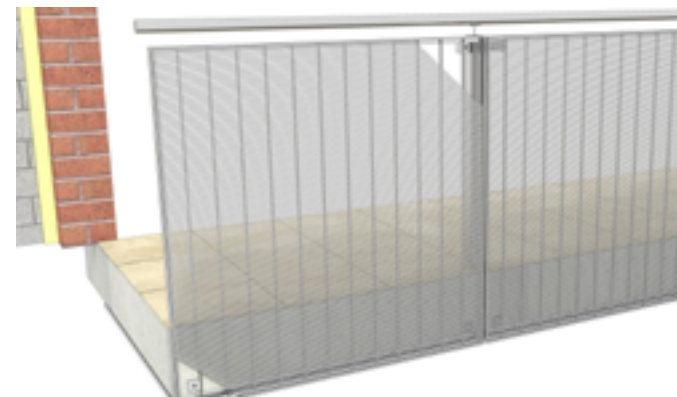
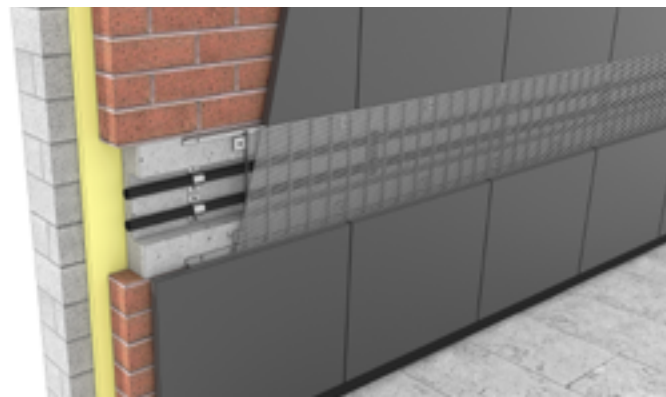

# CONFIGURATION OPTIONS

Grilles can be made to nearly any shape and format to suit your projects.

Shaping

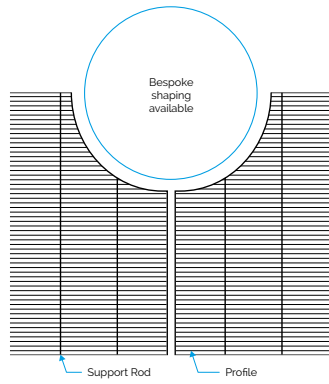

Corner Grilles

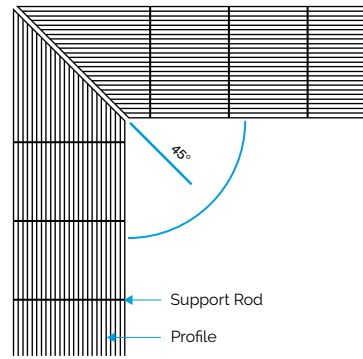

Radial Grids

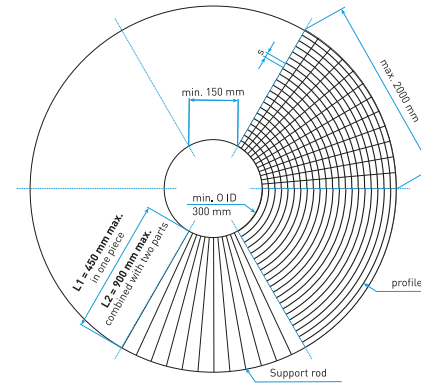

Bending in the vertical plane

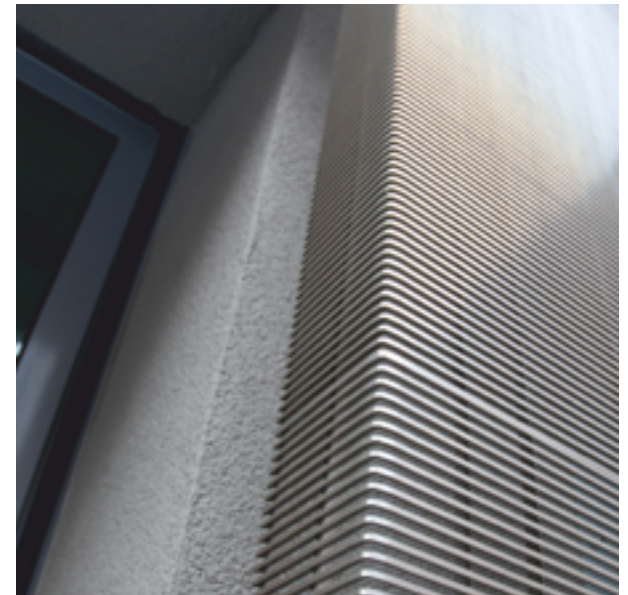
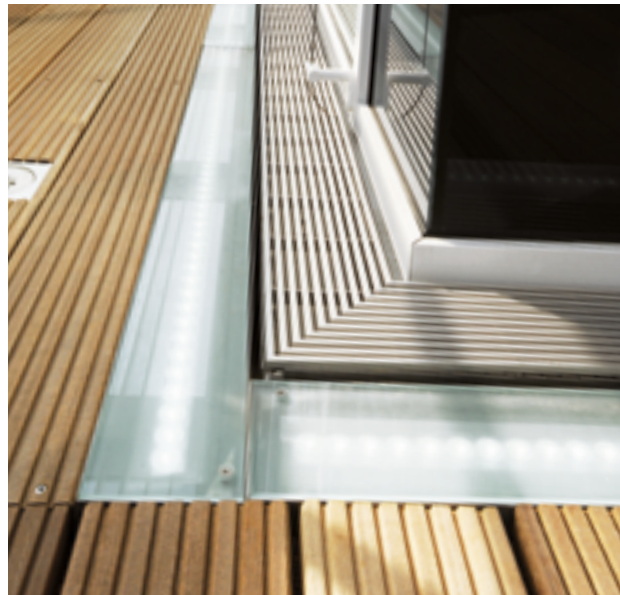
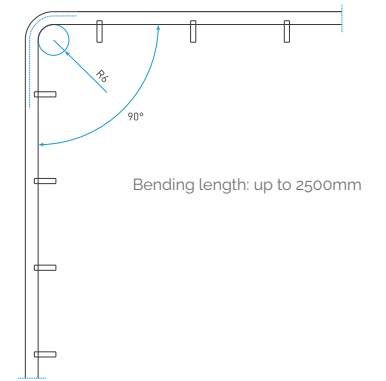

# SLOT OPENING

Slot size can be varied within a single grid with options for constant, increasing or alternating spacing to control the degree of screening and airflow

Profile configuration with constant slot opening

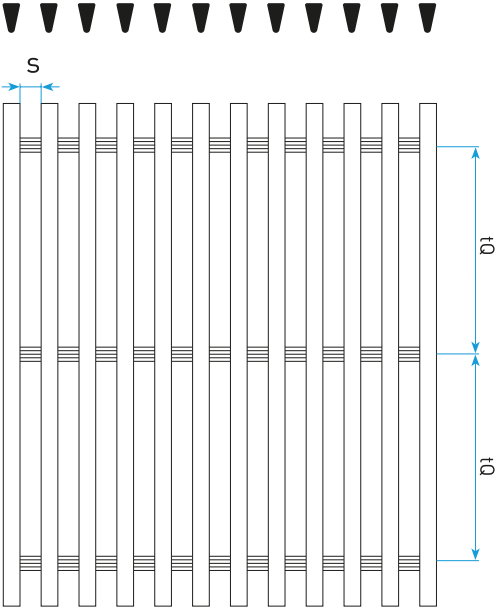

Profile configuration with alternating bigger and smaller slots

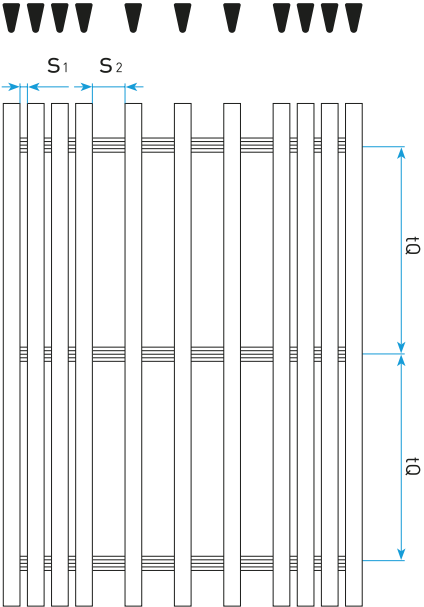

Profile configuration with increasing slot opening

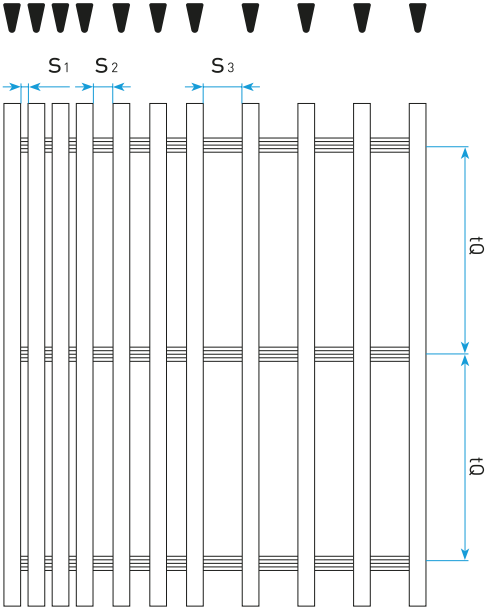

S = Slot spacing  
tQ = Variable support profile spacing

## DRAINAGE OPTIONS

Please contact us to specify details such as overall length, width, outlet type and location.

- Options available to suit a wide variety of applications
- Adjustable feet to suit drainage falls
- Suitable for internal and external applications

