

## INTEGRA 4000 FR Series RISER DOORS



For all bespoke requirements, our technical team will assist you to determine the correct specification and dimensions for your project.

**+44(0) 1827 719 051**

[technical@profabaccess.com](mailto:technical@profabaccess.com)

Visually discreet, fire rated up to 240 minutes, concealed metal riser doors delivering the highest standards in third party fire certification without compromising on architectural design

Profab Access' INTEGRA 4000 FR Series range of riser doors provides access into jointless plaster, plasterboard wall and masonry walls where access to mechanical and electrical services is required. Specified in commercial, residential and public buildings where low maintenance access is required behind walls and ceilings, they deliver the highest standards in fire safety, security and practicality with minimal compromises on design.

### » BENEFITS

- CERTIFIRE fire rated up to 240 minutes
- Bi-directionally tested for fire integrity from both sides
- Virtually invisible, for a clean, discreet design
- Seamless aesthetic finish
- Fast and simple to install, lockable
- Etch primed for decorating on site, to match adjacent finishes
- Single door (SD), double door (DD) and multi-leaf configurations
- High performance range, for vertical use with frame and lock options
- Fully recyclable at end of life



**SAFE ACCESS ALL AREAS**

## » TYPICAL DOOR CONFIGURATIONS

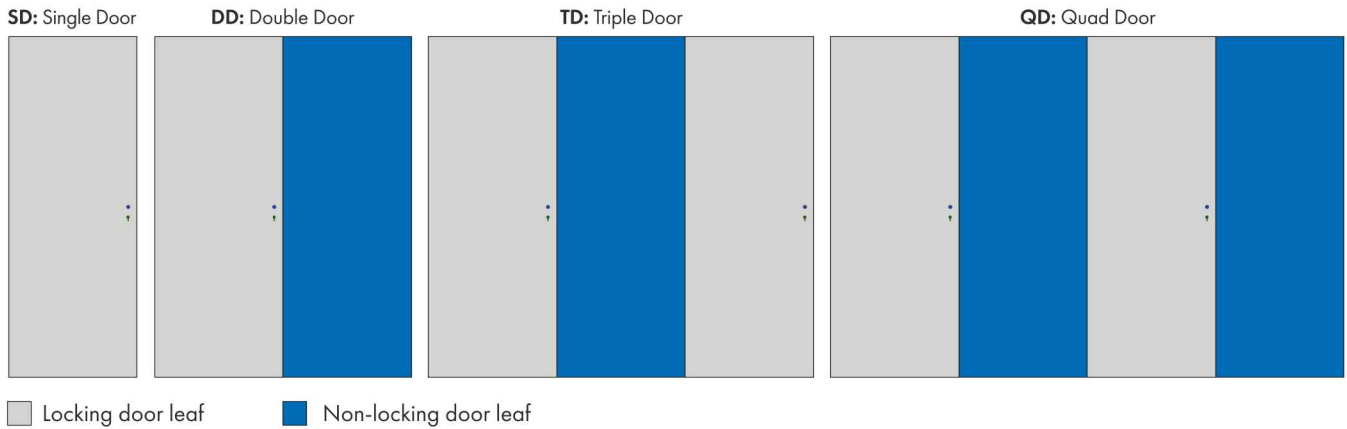

Full height single, double, triple and quad door leaf sets. 240 minutes fire rating. CERTIFIRE certification.

### Construction

- CNC manufactured to order
- 1.5 mm frame and 1.2 mm door in electro-galvanised mild steel
- Fully welded rigid box section frame
- Rockwool core door leaf
- 12.5 mm FireLine board door leaf backing
- All-in-one acoustic, intumescent and smoke seal
- Concealed continuous piano hinge
- Concealed 3 point lock (3PL) or Euro profile high security lock (3HS)
- Beaded frame (BF) or 25 mm picture frame (PF) to suit finishing requirements
- 3 mm even frame / door gap adjustment
- Fully powder coated matt RAL 9010, suitable for finishing on site
- CNC manufactured in the UK to ISO 9001:2015 and 14001:2015

### Performance

- Fire tested to BS EN 1634-1:2000
- CERTIFIRE fire rated up to 240 minutes
- Bi-directionally tested for fire integrity from both sides
- UL Labs fire certificated to 120 minutes
- 35 dB acoustic shielded as standard
- Airtight to Part L

### Options

- Single door (SD), double door (DD) and multi-leaf configurations
- Deep plaster frame (DPF) and dutch fold frame (DFF) on request
- Euro profile high security cylinder key lock (3HS)
- Up to 44 dB acoustic upgrade
- EI60 certified up to 80 minute insulation
- Visible or concealed escutcheon with suction cup
- Different ironmongery options available
- Left or right hand opening
- removable safety hand rails (SHR) to BS 6180:2011
- Shadow gap frame profiles
- Flush frame skirting profile
- Door closers
- Other RAL paint colours and textures available

## » MANUFACTURED TO ORDER

Our INTEGRA 4000 FR Series are made to order to suit site requirements in a range of configurations with a maximum leaf height of 3100 mm

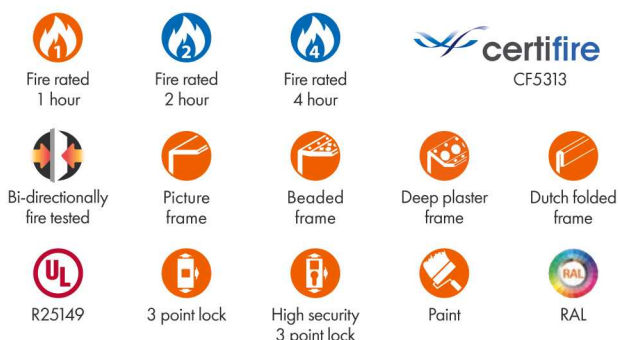

Third party, bi-directional fire testing to ensure fire integrity

## » MULTI-POINT LOCKING OPTIONS



### 3PL: THREE POINT LOCKING

- T bar key: used to unlatch and pull door leaf open
- Locking assembly: engages top, bottom and lock sides
- White plastic collar and plug as standard (stainless steel collar optional)

### 3HS: THREE POINT HIGH SECURITY LOCKING

- T bar key: used to unlatch and pull door leaf open
- Secondary locking
- Euro profile cylinder lock
- Locking assembly: engages top, bottom and lock sides
- White plastic collar and plug as standard (stainless steel collar optional)

### 3HSCE: CONCEALED LOCKING

- Magnetic escutcheon sits over the face of the lock for a concealed aesthetic finish
- Easily removed with a small rubber sucker

## » FRAME PROFILES

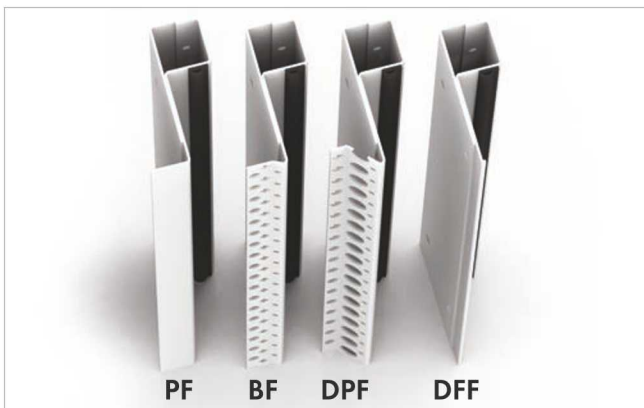

Choice of frame profiles to suit application

### PF: PICTURE FRAME

Ideal for retro fitting and finished areas

### BF: BEADED FRAME

Ideal for tape and jointing or skim-coat plastering

### DPF: DEEP PLASTER FRAME

Ideal for wet plastering/float and set

### DFF: DUTCH FOLDED FRAME

Ideal for masonry and blockwork

For more information about our full range of third party CERTIFIRE fire rated access panels and riser doors visit: [www.profabaccess.com](http://www.profabaccess.com)

The INTEGRA 4000 FR Series range of riser doors are bi-directionally fire tested to ensure fire integrity from both sides and are third party certified



Ask us for our latest test reports and certification to ensure legal compliance

The INTEGRA 4000 FR Series range of riser doors are designed and manufactured by Profab Access in our UK Factory

Our in-house manufacturing enables us to offer full flexibility in product design for projects that need to meet specific design criteria



The Profab Access INTEGRA 4000 FR Series range of riser doors is available to download now as BIM objects for use in your current and future projects



## » CAD DRAWINGS

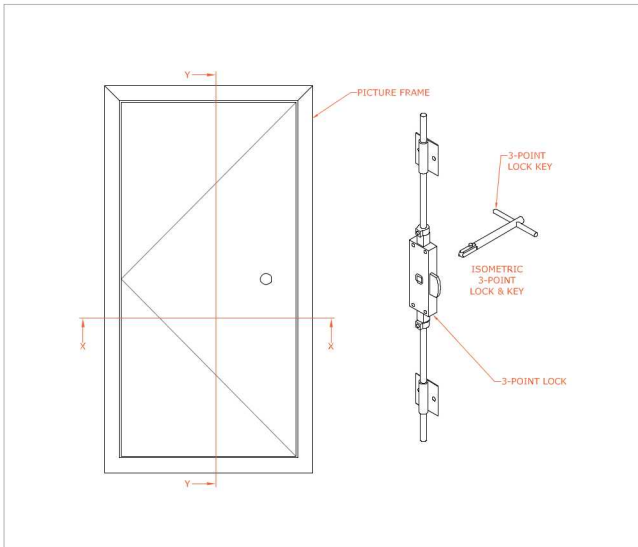

2 hour fire rated, picture frame, metal door, 3 point lock, single door 4000-2FR-PF-MD-3PL-SD

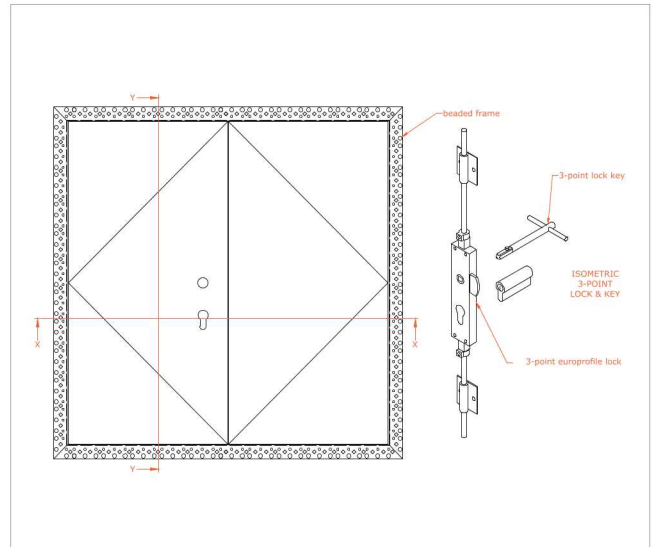

2 hour fire rated, beaded frame, metal door, 3 point high security lock, double door 4000-2FR-BF-MD-3HS-DD

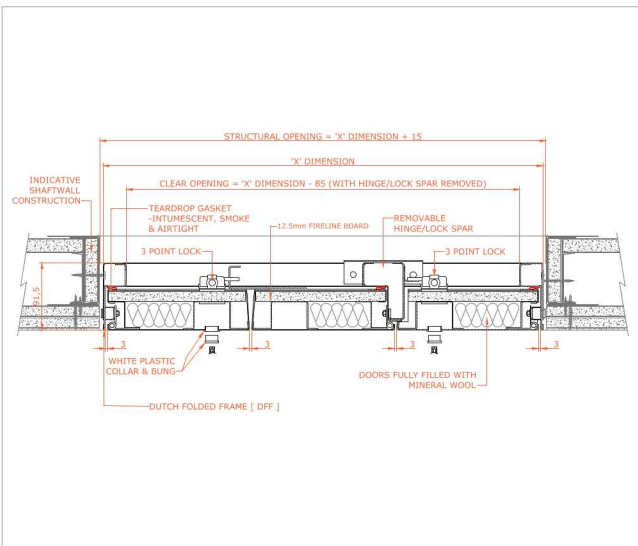

2 hour fire rated, dutch folded frame, metal door, 3 point lock, triple door 4000-2FR-DFF-MD-3PL-TD

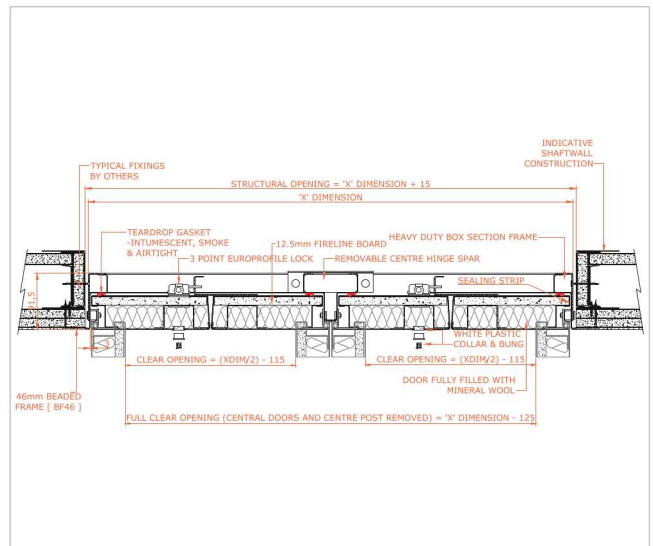

2 hour fire rated, beaded frame, metal door, 3 point high security lock, quad door 4000-2FR-BF-MD-3HS-QD

CAD files for all product variants are available – please contact: [technical@profabaccess.com](mailto:technical@profabaccess.com)

**All of our digital resources can be downloaded from: [www.profabaccess.com](http://www.profabaccess.com)**

Profab Access reserve the right to amend any of our published information and specifications deemed necessary as part of our continuous product development and improvement policy, without prior notice.

## » CONTACT US

**Sales Enquiries**  
+44(0) 1827 718 222  
[sales@profabaccess.com](mailto:sales@profabaccess.com)

[www.profabaccess.com](http://www.profabaccess.com)

**Technical Enquiries**  
+44(0) 1827 719 051  
[technical@profabaccess.com](mailto:technical@profabaccess.com)



Riversdale House  
Units C-D Riversdale Road  
Carlyon Road Industrial Estate  
Atherstone  
Warwickshire CV9 1FA  
United Kingdom

