

Ecophon Hygiene Clinic™ A

Ecophon Hygiene Clinic™ A has an exposed grid, suitable for dry areas. The absorbers have low emission levels, ensuring high indoor air quality. They are resistant to mould and bacteria growth and withstand HPV cleaning.

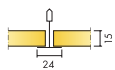

SYSTEM RANGE



Size, mm	600x600	1200x600
T24	•	•
Thickness	15	15
Inst. Diagr.	M338	M338



Section of Hygiene Clinic A system

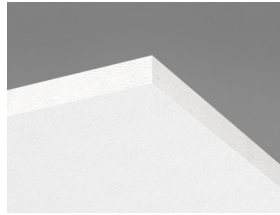

Hygiene Clinic A tile



Hygiene Clinic A system

Acoustic



Sound Absorption:

Test results according to EN ISO 354. Classification according to EN ISO 11654.

α_p , Practical sound absorption coefficient

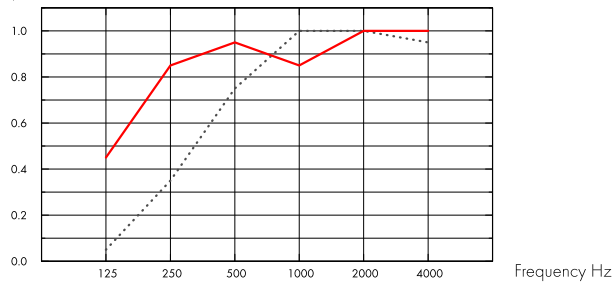

... Hygiene Clinic A 15 mm, 50 mm o.d.s.

— Hygiene Clinic A 15 mm, 200 mm o.d.s.

o.d.s = overall depth of system

THK mm	o.d.s. mm	α_p , Practical sound absorption coefficient						α_w	Sound absorption class
		125 Hz	250 Hz	500 Hz	1000 Hz	2000 Hz	4000 Hz		
15	50	0.05	0.35	0.75	1.00	1.00	0.95	0.65	C
15	200	0.45	0.85	0.95	0.85	1.00	1.00	0.95	A

THK mm	o.d.s. mm	NRC	SAA
15	50	0.80	0.79
15	200	0.90	0.91

Indoor Air Quality



Certificate / Label	
Eurofins Indoor Air Comfort®	IAC
French VOC	A
Finnish M1	•



Environmental Footprint



	kg CO ₂ equiv/m ²
Hygiene Clinic A	2,60

Life-cycle stages A1 to C4 from EPD, in conformity with ISO 14025 / EN 15804

Circularity



Minimum post-consumer recycled content	46%
Recyclability	Fully recyclable



Fire safety

Country	Standard	Class
Europe	EN 13501-1	A2-s1,d0

The glass wool core of the tiles is tested and classified as non-combustible according to EN ISO 1182.



Humidity Resistance

Class C, relative humidity 95% and 30°C, according to EN 13964:2014



Visual appearance

White 500, nearest NCS colour sample S 0500-N, 84% light reflectance.



Cleanability

Daily dusting and vacuum cleaning. Weekly wet wiping.



Advanced Cleanability

Withstand use of hydrogen peroxide vapor and compatible with UV-C disinfection, BIFMA HCF 8.1-2019



Mould and Bacterial Resistance

Standard/Method	
ISO 846 A	0
ISO 846 C	0



Clean Room

Standard	Standard/Method	Class
ISO 14644	Particle cleanliness class	ISO 4
NF S 90-351	Microbiological class	M1/area 4
NF S 90-351	Particle elimination kinetics	CP(0,5) 5



Accessibility

The tiles are easily demountable. Minimum demounting depth according to installation diagrams.



Installation

Installed according to installation diagrams, installation guides and drawing aid. For information regarding minimum overall depth of system see quantity specification.



System weight

The weight of the system (including suspension grid) should be approximately 2,5 kg/m².



Mechanical properties

See table about Max live load and Min load bearing capacity and Functional demands, Mechanical properties at www.ecophon.com.



CE

Ecophon ceiling systems are CE marked according to the European harmonized standard EN 13964:2014. CE marked construction products are covered by a Declaration of Performance (DOP) which enables customers and users to easily compare performance of products available on the European market.

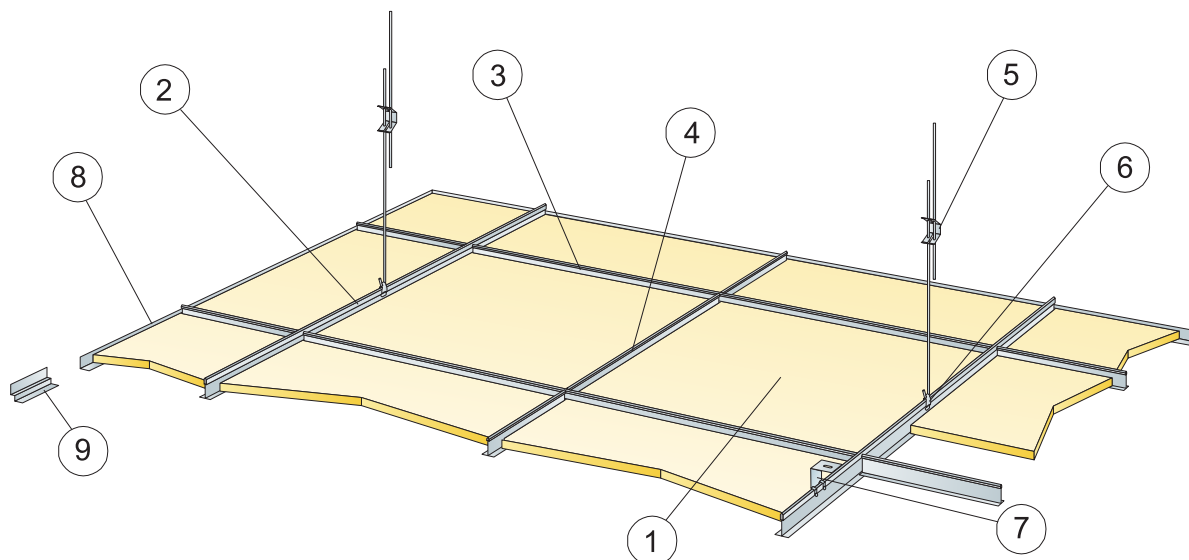

© Ecophon Group

QUANTITY SPECIFICATION (EXCL. WASTAGE)

	Size, mm	
	600x600	1200x600
1 Hygiene Clinic A	2,8/m ²	1,4/m ²
2 Connect T24 Main Runner, installed at 1200 mm centres (max distance from wall 300 mm)	0,9m/m ²	0,9m/m ²
3 Connect T24 Cross Tee, L=1200 mm, installed at 600 mm centres	1,7m/m ²	1,7m/m ²
4 Connect T24 Cross Tee, L=600 mm	0,9m/m ²	-
5 Connect Adjustable Hanger, installed at 1200 mm centres (max. distance from wall 600 mm)	0,7/m ²	0,7/m ²
6 Connect Hanger Clip (not to be used in swimming hall environments)	0,7/m ²	0,7/m ²
7 For direct installation: Connect Direct Bracket, installed at 1200 mm centres	0,7/m ²	0,7/m ²
8 Connect Angle Trim, fixed at 300 mm centres	as required	as required
9 Connect Shadowline Trim, fixed at 300 mm centres	as required	as required
Δ Min. overall depth of system, with adjustable hanger: 100 mm, with direct bracket: 50 mm	-	-
δ Min. demounting depth: 120 mm	-	-

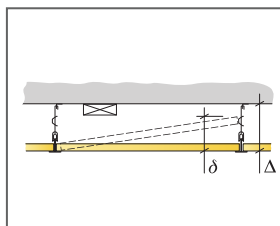

See Quantity Specification

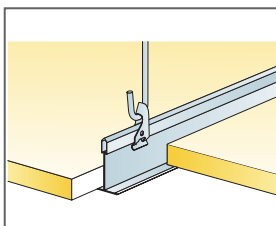

Suspension with Connect Adjustable Hanger and Connect Hanger Clip

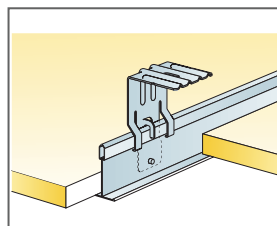

Suspension with Connect Direct Bracket

Size, mm	Max live load (N)	Min load bearing capacity (N)
600x600x15	50	160
1200x600x15	50	160

Live load/load bearing capacity