



RECYFIX[®] PRO

Corrosion-free linear drainage
for private and public areas -
up to load class D400kN



Contents

Product range		Loading category	Page
RECYFIX PRO	Overview		3
	Features & Benefits		4-5
	Applications		6-7
RECYFIX PRO 100	Galvanized and stainless steel slotted gratings	Class A15	8
	GUGI Ductile iron gratings Galvanized mesh gratings	Class B125	9
	FIBRETEC slotted HEELSAFE gratings Ductile iron longitudinal gratings with KTL finish	Class C250	10
	Ductile iron longitudinal gratings with KTL finish Galvanized and stainless steel slotted gratings Galvanized and stainless steel reinforced slotted gratings. Reinforced ductile iron gratings	Class C250/D400	11
	Accessories - Trash boxes	Classes A15, B125, C250, D400	12
	Accessories - End caps Further accessories - Foul air traps etc	N/A	13
	RECYFIX PRO 150	FIBRETEC slotted HEELSAFE Gratings	Class B125
Ductile iron longitudinal gratings with KTL finish		Class C250	15
Accessories - Trash boxes		Classes B125, C250	16
Accessories - End caps		N/A	
Further accessories - Mud bucket etc		N/A	17
RECYFIX PRO 200	FIBRETEC slotted HEELSAFE gratings	Class B125	18
	Ductile iron longitudinal gratings with KTL finish G-TEC ductile iron grating with KTL finish	Class C250	
	G-TEC ductile iron grating with KTL finish	D400	19
	Accessories - Trash boxes	Classes B125, C250, D400	20
	Accessories - End caps	N/A	
	Further accessories - Mud bucket etc	N/A	21
RECYFIX PRO 300	G-TEC ductile iron grating, eight bolt fixing with KTL finish	Class C250	22
	G-TEC ductile iron grating, eight bolt fixing with KTL finish	Class D400	
	Accessories - End caps	N/A	23

RECYFIX® PRO

Corrosion-free drainage system for private and public areas.

1 Requirements

- Drainage channels for optically attractive areas have to
- be modern and unique in their design.
 - be extremely stable to guarantee long-term and permanent security.
 - be resistant to environmental influences (frost, heat and moisture).
 - be designed in accordance with DIN EN 1433.

2 Application areas

- private and public areas
- squares and parks
- railway platform's
- driveways and car parks

3 Solutions

RECYFIX PRO Channels are suitable for the drainage of a wide variety of applications:

- channel and angle housing made of 100% recycled composite
- secure and corrosion-free grating
- loading capacity up to D 400
- hydraulically optimized FIBRETEC Slotted grating

A selection of Hydraulic Performance tables for the most popular sizes of FASERFIX® and RECYFIX® channels including the RECYFIX® MONOTEC and RECYFIX® HICAP® ranges are available on request in an 8 page hard copy or PDF publication.

Hauraton channel drainage configurations are designed and sized using in-house **Hydraulic design software**. The accuracy of the software has been verified by physical testing of Hauraton systems within a hydraulic discharge test flume, replicating and evaluating hundreds of flow scenarios.

Hydraulic design software is also available free of charge to industry professionals. Intuitive and user friendly, **Hauraton Design Software** allows engineers to create drainage schemes for the company's range of civil engineering systems on tablets, desktop computers or through the internet (web-based application).

For smaller projects where a quick indication of the appropriate channel size and system is required for a given catchment area, Hauraton can provide their **Hydraulic Design App**.

For further details contact the Hauraton Technical Support Team



The features and benefits of **RECYFIX®** PRO channels

100% corrosion-free

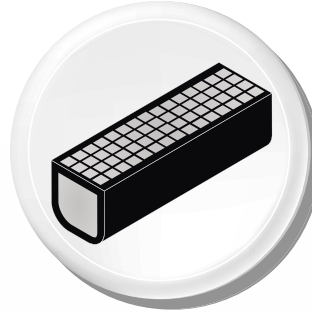

pre-assembled ready for installation

- channel and grating = one part
 - no spare parts
 - easy handling of stock and on construction site
 - cost-efficient transport
- = easy to transport and install**



angle housing

- PP-angle housing acc. DIN 19580
 - ridges to stop any lateral movement
 - inlaying gratings
- = security**



low weight ensures easy handling on site

- much lighter than channels made of polymer concrete
 - easy transport and installation
- = cost savings**

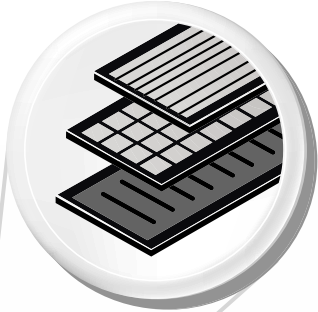

corrosion-free gratings

- high-grade recycled composite
- FIBRETEC Slotted grating: anti-slip surface, hydraulically optimized with elegant inlet slots

= flexibility / security

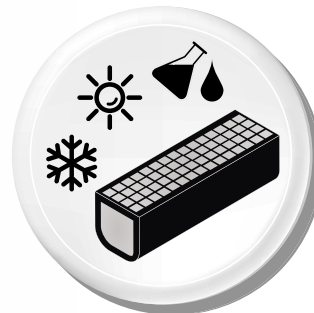

high resistance

- high resistance against frost, de-icing salt and UV rays
- withstands high temperature differences

= durability

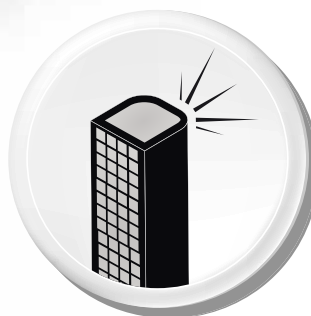

award-winning design

- FIBRETEC Slotted gratings honoured with Focus Open Design Award
- nomination for German design prize

= high quality work

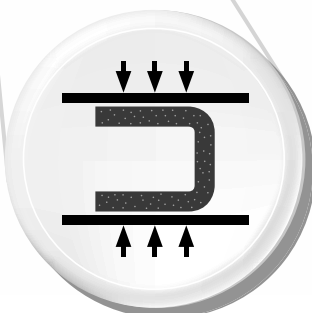

high-grade material

- RECYFIX - stable and secure
- elastic and especially robust material

= security

RECYFIX® PRO

Corrosion-free drainage system for private and public areas.

RECYFIX PRO channels meet the requirements of DIN EN 1433 and are suitable for the following load categories:



Category A 15, Load class 15 kN



Category B 125, Load class 125 kN



Category C 250, Load class 250 kN



Category D 400, Load class 400 kN

If in doubt, always select the higher class.

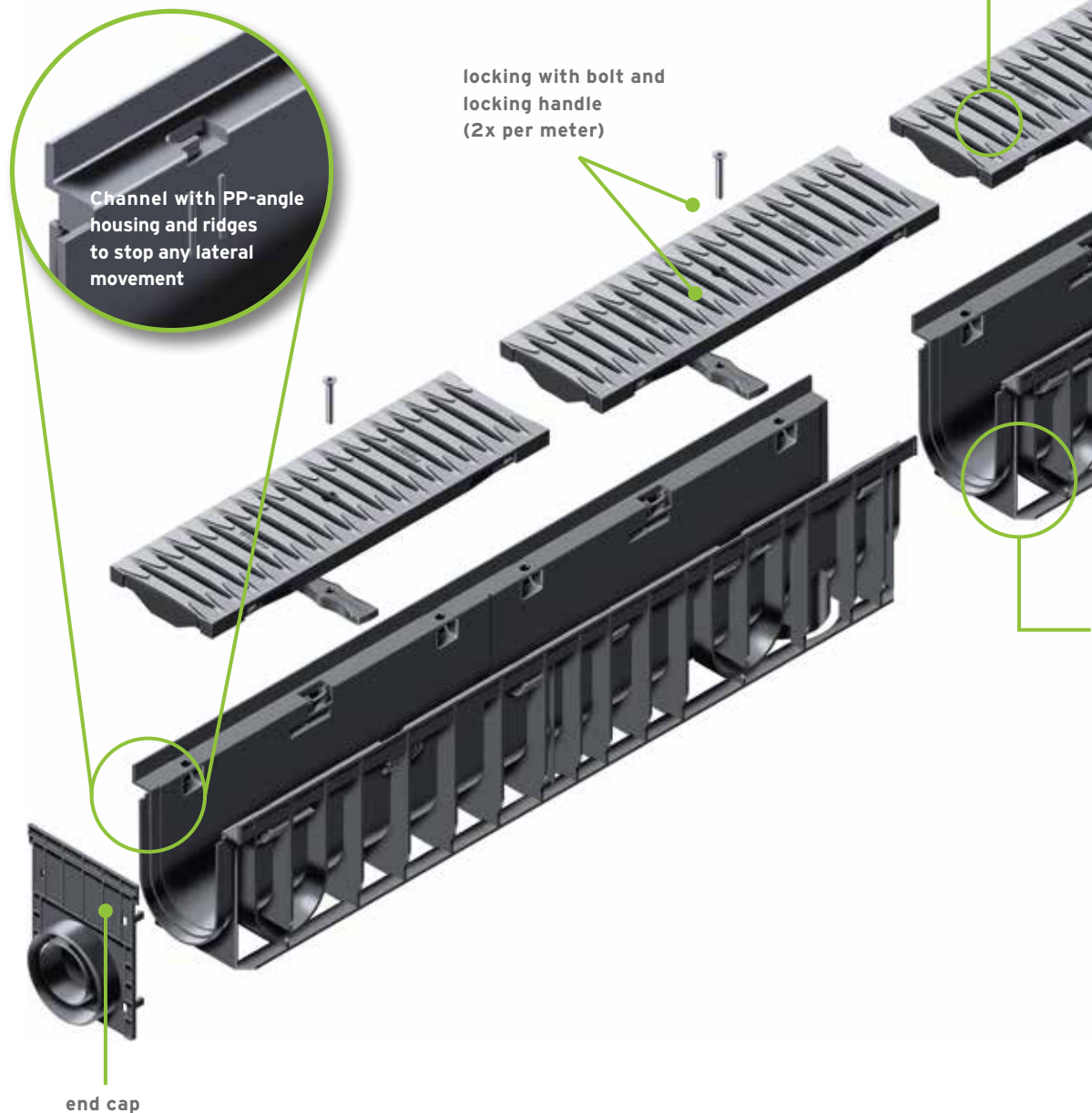

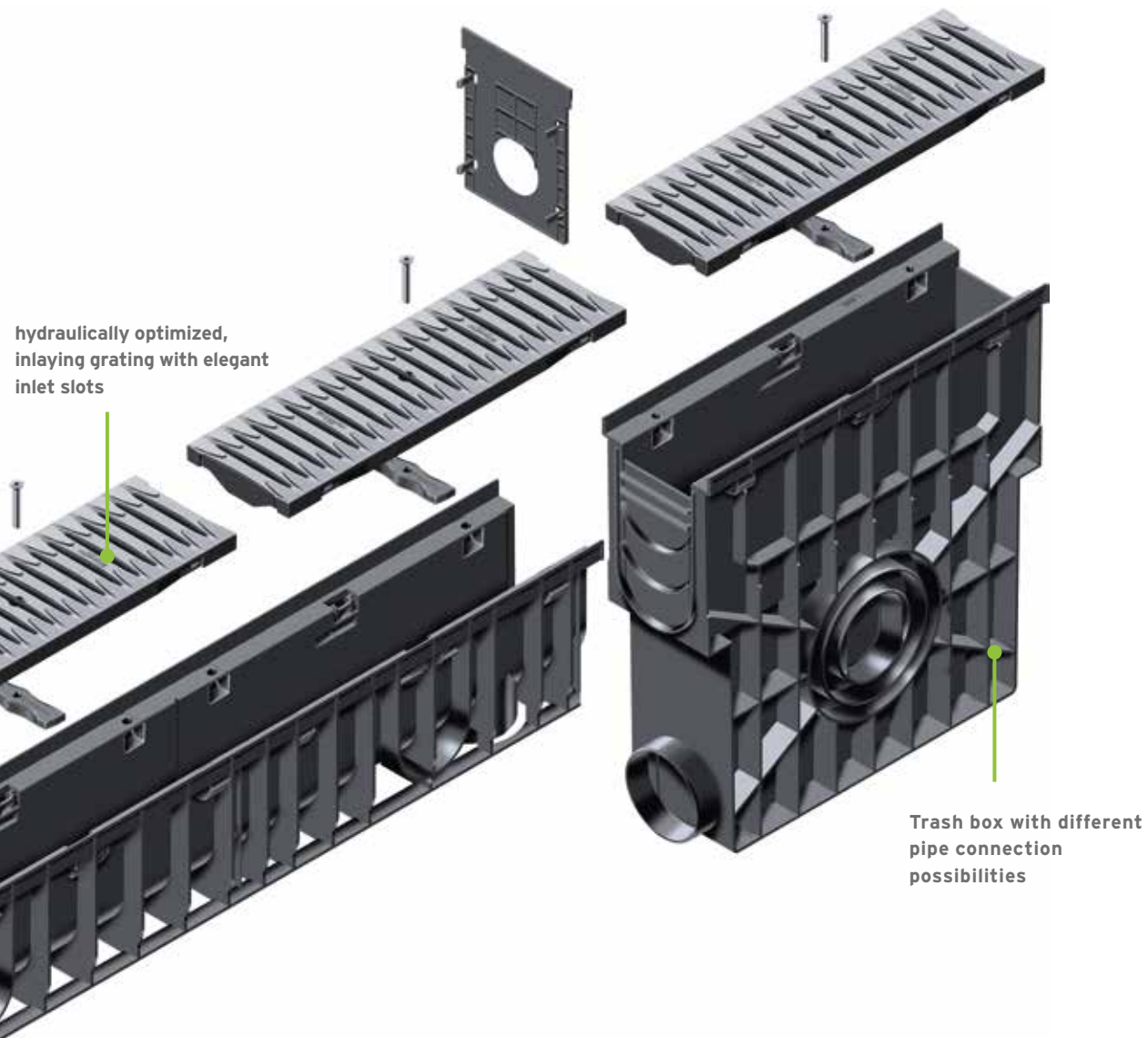

hydraulically optimized,
inlaying grating with elegant
inlet slots

Trash box with different
pipe connection
possibilities

tongue and groove
connection for exact
installation

RECYFIX®PRO 100

Combi article

RECYFIX®PRO 100, class A 15

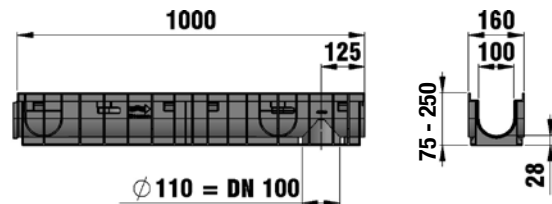

	Length mm	Width mm	Height mm	Invert mm	Drainage cross-sect. cm ²	Intake cross- sect. cm ² /m	Weight kg	Item-No. galvanised	Item-No. stainless steel
Type 01 with Slotted grating SW 80/10, locked	1000	160	150	122	92	278	4,8	47021	47026
Type 0105 with Slotted grating SW 80/10, locked	500	160	150	122	92	278	2,4	47022	47027
Type 010 with Slotted grating SW 80/10, locked	1000	160	200	172	142	278	5,4	47023	47028
Type 01005 with Slotted grating SW 80/10, locked	500	160	200	172	142	278	2,7	47024	47029
Type 020 with slotted grating, SW 80/10, locked	1000	160	250	222	192	278	6,6	48621	48622
Type 02005 with slotted grating, SW 80/10, locked	500	160	250	222	192	278	3,2	48671	48672
Type 75 with slotted grating, SW 80/10, locked	1000	160	75	55	35	278	4,0	47018	47012
Type 95 with slotted grating, SW 80/10, locked	1000	160	95	75	55	278	4,6	47019	47013

The quality of stainless steel material corresponds to CNS 1.4301.

RECYFIX®PRO 100

RECYFIX®PRO 100, class B 125

GUGI-Grating made of PA-GF, MW 15/25, black, locked

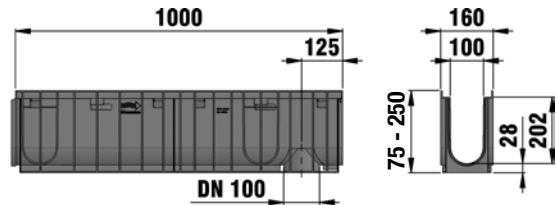
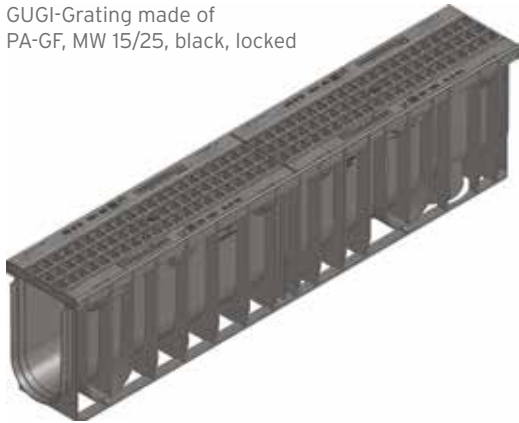

	Length mm	Width mm	Height mm	Invert mm	Drainage cross-sect. cm ²	Intake cross-sect. cm ² /m	Weight kg	Item No.
Type 01 with GUGI-Grating made of PA-GF, MW 15/25, black, locked	1000	160	150	122	92	444	4,3	47035
Type 0105 with GUGI-Grating made of PA-GF, MW 15/25, black, locked	500	160	150	122	92	444	2,1	47036
Type 010 with GUGI-Grating made of PA-GF, MW 15/25, black, locked	1000	160	200	172	142	444	4,7	47040
Type 01005 with GUGI-Grating made of PA-GF, MW 15/25, black, locked	500	160	200	172	142	444	2,5	47041
Type 020 with GUGI-Grating made of PA-GF, MW 15/25, black, locked	1000	160	250	222	192	444	5,5	48623
Type 02005 with GUGI-Grating made of PA-GF, MW 15/25, black, locked	500	160	250	222	192	444	2,8	48673
Type 75 with GUGI-Grating made of PA-GF, MW 15/25, black, locked	1000	160	75	55	35	444	2,9	47032
Type 95 with GUGI-Grating made of PA-GF, MW 15/25, black, locked	1000	160	95	75	55	444	3,6	47033
Type 01 with mesh grating, MW 30/10, galvanised, locked	1000	160	150	122	92	878	6,4	47034
Type 0105 with mesh grating, MW 30/10, galvanised, locked	500	160	150	122	92	869	3,0	47157
Type 01 with mesh grating, MW 30/10, stainless steel, locked	1000	160	200	172	92	878	5,7	47037
Type 0105 with mesh grating, MW 30/10, stainless steel, locked	1000	160	150	130	92	869	2,8	47158

RECYFIX® PRO 100

RECYFIX® PRO 100, class C 250

With FIBRETEC slotted grating,
SW 9, HEELSAFE, black C 250

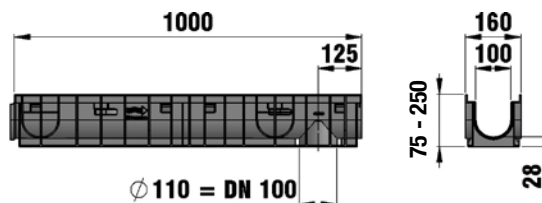

With ductile longitudinal grating,
KTL, locked D400



	Length mm	Width mm	Height mm	Invert mm	Drainage cross-sect. cm ²	Intake cross-sect. cm ² /m	Weight kg	Item-No. galvanised	Item-No. stainless steel
Type 01 with FIBRETEC slotted grating, SW 9, HEELSAFE, black	1000	160	150	122	92	372	4,6	47055	-
Type 0105 with FIBRETEC slotted grating, SW 9, HEELSAFE, black	500	160	150	122	92	372	2,3	47056	-
Type 010 with FIBRETEC slotted grating, SW 9, HEELSAFE, black	1000	160	200	172	142	372	4,9	47060	-
Type 01005 with FIBRETEC slotted grating, SW 9, HEELSAFE, black	500	160	200	172	142	372	2,5	47061	-
Type 020 with FIBRETEC slotted grating, SW 9, HEELSAFE, black, locked	1000	160	250	222	192	372	5,8	48625	-
Type 02005 with FIBRETEC Slotted grating, SW 9, HEELSAFE, black, locked	500	160	250	222	192	372	3,0	48675	-
Type 75 with FIBRETEC slotted grating, SW 9, HEELSAFE, black	1000	160	75	55	35	372	3,4	47062	-
Type 95 with FIBRETEC slotted grating, SW 9, HEELSAFE, black	1000	160	95	75	55	372	3,7	47063	-
Type 01 with ductile longitudinal grating, KTL, locked	1000	160	150	122	92	528	10,4	48634	-
Type 0105 with ductile longitudinal grating, KTL, locked	500	160	150	122	92	528	5,2	48635	-
Type 010 with ductile longitudinal grating, KTL, locked	1000	160	200	172	142	528	11,1	48645	-
Type 01005 with ductile longitudinal grating, KTL, locked	500	160	200	172	142	528	5,6	48646	-

RECYFIX®PRO 100

RECYFIX®PRO 100, class C 250

	Length mm	Width mm	Height mm	Invert mm	Drainage cross-sect. cm ²	Intake cross-sect. cm ² /m	Weight kg	Item-No. galvanised	Item-No. stainless steel
Type 020 with longitudinal ductile iron grating, KTL-coated, slot distance 9mm, locked	1000	160	250	172	192	528	7,5	48626	-
Type 02005 with longitudinal ductile iron grating, SW 9, KTL-coated, black, locked	500	160	250	222	192	528	5,6	48676	-
Type 75 with ductile longitudinal grating, KTL, locked	1000	160	75	55	35	528	9,5	47038	-
Type 95 with ductile longitudinal grating, KTL, locked	1000	160	95	75	55	528	10,0	47039	-
Type 01 with Slotted grating SW 80/10, locked	1000	160	150	122	92	281	7,3	47074	47084
Type 0105 with Slotted grating SW 80/10, locked	500	160	150	122	92	281	3,7	47075	47085
Type 010 with Slotted grating SW 80/10, locked	1000	160	200	172	142	281	7,6	47076	47086
Type 01005 with Slotted grating SW 80/10, locked	500	160	200	172	142	281	4,0	47077	47087
Type 020 with reinforced slotted grating, SW 80/10, locked	1000	160	250	222	192	281	9,0	48627	48628
Type 02005 with reinforced slotted grating, SW 80/10, locked	500	160	250	222	192	281	4,5	48677	48678
Type 75 with reinforced grating, locked*	1000	160	75	55	35	281	6,5	47014	47016
Type 95 with reinforced grating, SW 80/10, locked	1000	160	95	75	55	281	6,9	47015	47017
Type 01 with FIBRETEC design slotted grating in the colour Sand, SW 9 mm, HEELSAFE, locked	1000	160	150	122	92	372	4.60	47405	-
Type 01 with FIBRETEC design slotted grating in the colour Fern, SW 9 mm, HEELSAFE, locked	1000	160	150	122	92	372	4.60	47417	-
Type 01 with FIBRETEC design slotted grating in the colour Stone, SW 9 mm, HEELSAFE, locked	1000	160	150	122	92	372	4.60	47411	-

The quality of stainless steel material corresponds to CNS 1.4301.
Other sizes of channel available on request.

RECYFIX®PRO 100, class D 400

	Length mm	Width mm	Height mm	Invert mm	Internal cross-sect. cm ² /m	Intake cross-sect. cm ² /m	Weight kg	Item-No.
Type 01 with ductile iron deign grating METROLOIS, black KTL-coated, locked	1000	160	150	122	92	165	12,40	47002
Type 01 with longitudinal ductile iron grating, galvanised, locked	1000	160	150	122	92	165	10,40	48632
Type 01 with longitudinal ductile iron grating, KTL coated, locked	1000	160	150	122	92	165	10,40	48630

RECYFIX® PRO 100

Accessories

Trash boxes



Trash box with PE mud bucket and Slotted grating SW 80/10, cl. A 15, locked



Trash box with galvanised mud bucket and GUGI-Grating made of PA-GF, MW 15/25, black



Trash box with PE mud bucket and mesh grating MW 30/30, cl. B 125, locked



Trash box with PE mud bucket and FIBRETEC slotted grating, SW 9, black

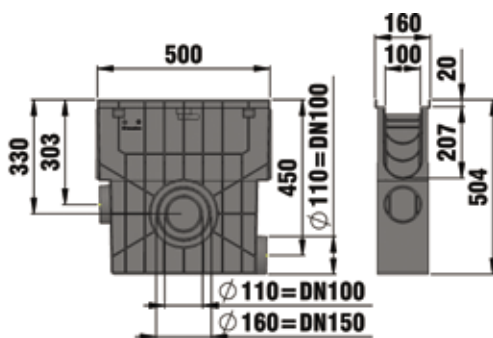

	Length mm	Width mm	Height mm	Weight kg	Item-No. galva- nised	Item-No. stainless steel
Trash box with PE mud bucket and Slotted grating SW 80/10, cl. A 15, locked	500	160	504	5,7	47025	47043
Trash box with galvanised mud bucket and GUGI-Grating made of PA-GF, MW 15/25, black B 125	500	160	504	5,9	47053	-
Trash box with PE mud bucket and mesh grating MW 30/30, cl. B 125, locked	500	160	504	5,9	47048	-
Trash box with PE mud bucket and FIBRETEC composite slotted grating, SW 9, black C 250	500	160	504	5,9	47054	-
Trash box with PE mud bucket and with ductile longitudinal grating, KTL, cl. C 250, locked	500	160	504	8,1	48655	-
Trash box with PE mud bucket and Slotted grating SW 80/10, cl. C 250, locked	500	160	504	7,1	47078	47088
Trash box with PE mud bucket and ductile iron grating METROPOLIS, black, KTL, locked D 400	500	160	504	9,5	48657	-
Trash box with PE mud bucket and longitudinal ductile iron grating galvanised, locked D 400	500	160	504	8,1	48654	-
Trash box with PE mud bucket and longitudinal ductile iron grating, KTL, cl. D 400 locked	500	160	504	8,6	48653	-
Trash box with plastic mud bucket and mesh grating MW 30/10 cl. B 125 locked	500	160	504	6,4	47052	47059

The quality of stainless steel material corresponds to CNS 1.4301.

RECYFIX® PRO 100

End caps



End cap closed for type 01



End cap made of PP with outlet DN 100 for type 01

	Length mm	Width mm	Height mm	Weight kg	Item No.
End cap closed for type 01	-	160	124	-	48681
End cap with outlet DN 100 for type 01	-	160	200	0,1	48691
End cap closed for type 010	-	160	176	0,1	47082
End cap with outlet DN 100 for type 010	-	160	201	0,1	47093
End cap, Type 020	-	160	-	0,1	48683
End cap with outlet DN 100, type 020	-	160	-	0,1	48695
End cap Type 75	-	160	61	-	47097
End cap Type 95	-	160	81	-	47098

Further accessories



Foul air trap for RECYFIX trash box 100



Foul air trap, vertical, DN 100



Foul air trap set, vertical DN 100 for RECYFIX 100



Step Fall Adapter for step slope, from type 01 to type 010, from type 010 to type 020

	Length mm	Width mm	Height mm	Weight kg	Item No.
Foul air trap for RECYFIX trash box 100	75	78	135	0,1	967
Foul air trap, vertical, DN 100	-	187	181	0,6	40295
Foul air trap set, vertical DN 100 for RECYFIX 100	-	-	203	0,4	40294
Foul air trap, horizontal, with rubber sealing, black	-	-	-	0,1	966
Mud bucket vertical DN 100, black	100	100	85	-	40293
Step Fall Adapter for step slope, from type 01 to type 010, from type 010 to type 020	174	98	92	0,2	48790

RECYFIX®PRO 150

Combi article

RECYFIX®PRO 150, class B 125

Type 01 with FIBRETEC Slotted grating, SW 9 mm, HEELSAFE, black, locked

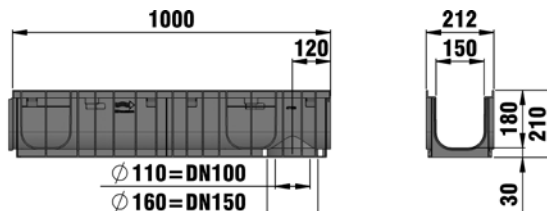

	Length mm	Width mm	Height mm	Invert mm	Drainage cross-sect. cm ²	Intake cross-sect. cm ² /m	Weight kg	Item No.
Type 01 with FIBRETEC Slotted grating, SW 9 mm, HEELSAFE, black, locked	1000	212	210	180	230	500	7,4	47135
Type 0105 with FIBRETEC Slotted grating, SW 9 mm, HEELSAFE, black, locked	500	212	210	180	230	500	3,7	47136
Type 115 with FIBRETEC Slotted grating, SW 9 mm, HEELSAFE, black, locked	1000	212	115	95	116	500	6,1	47133



RECYFIX®PRO 150

RECYFIX®PRO 150, class C 250

Type 115 with longitudinal ductile iron grating, KTL, locked

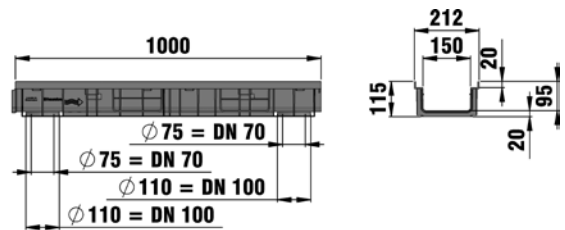

	Length mm	Width mm	Height mm	Invert mm	Drainage cross-sect. cm ²	Intake cross-sect. cm ² /m	Weight kg	Item No.
Type 01 with longitudinal ductile iron grating, KTL, locked	1000	212	210	180	230	740	17,1	47131
Type 0105 with longitudinal ductile iron grating, KTL, locked	500	212	210	180	230	740	8,6	47137
Type 115 with longitudinal ductile iron grating, KTL, locked	1000	212	115	95	116	740	15,9	47134



RECYFIX® PRO 150

Accessories

Trash boxes



Trash box with galvanised mud bucket and FIBRETEC Slotted grating, black, SW 9 mm, cl. B 125, locked



Trash box with galvanised mud bucket and longitudinal ductile iron grating, KTL, cl. C 250, locked

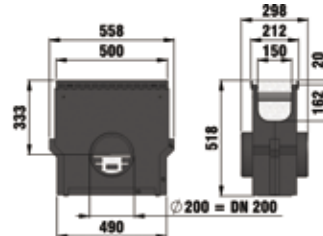

	Length mm	Width mm	Height mm	Weight kg	Item No.
Trash box with galvanised mud bucket and FIBRETEC Slotted grating, black, SW 9 mm, cl. B 125, locked	500	212	518	18,7	47153
Trash box with galvanised mud bucket and longitudinal ductile iron grating, KTL, cl. C 250, locked	500	212	518	23,6	47154

End caps



End cap closed, type 115



End cap combined, PP with outlet DN 70/100 for type 01

	Length mm	Width mm	Height mm	Weight kg	Item No.
End cap closed, type 115	-	208	100	-	47197
End cap combined, PP with outlet DN 70/100 for type 01	-	210	218	0,2	40591

RECYFIX® PRO 150

Further accessories



Mud bucket vertical DN 100, black



Mud bucket DN 150

	Length mm	Width mm	Height mm	Weight kg	Item No.
Mud bucket vertical DN 100, black	100	100	85	-	40293
Mud bucket DN 150	-	-	180	0,6	2191



RECYFIX®PRO 200

Combi article

RECYFIX®PRO 200, class B 125

Type 010 with FIBRETEC Slotted grating, SW 9 mm, HEELSAFE, black, locked

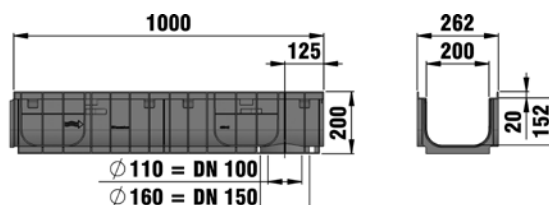

	Length mm	Width mm	Height mm	Invert mm	Drainage cross-sect. cm ²	Intake cross-sect. cm ² /m	Weight kg	Item No.
Type 010 with FIBRETEC Slotted grating, SW 9 mm, HEELSAFE, black, locked	1000	262	200	172	294	656	8,3	47246
Type 115 with FIBRETEC Slotted grating, SW 9 mm, HEELSAFE, black, locked	1000	262	115	95	150	656	7,0	47233
Type 010 with mesh grating mw 30/10 locked	1000	262	200	172	294	1912	11,0	47248

RECYFIX®PRO 200, class C 250

Type 010 with longitudinal ductile iron grating, KTL, locked

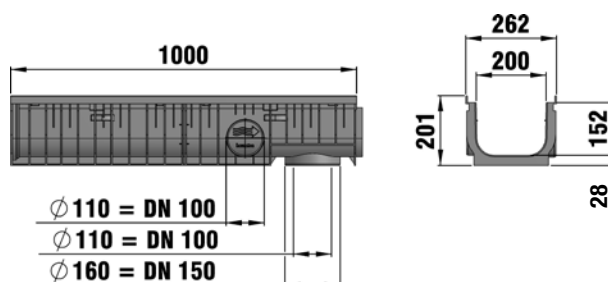

	Length mm	Width mm	Height mm	Invert mm	Drainage cross-sect. cm ²	Intake cross-sect. cm ² /m	Weight kg	Item No.
Type 010 with longitudinal ductile iron grating, KTL, locked	1000	262	200	172	294	951	22,6	47247
Type 115 with longitudinal ductile iron grating, KTL, locked	1000	262	115	95	150	951	21,6	47234
Type 010 with G-TEC grating, black, KTL-coated, locked	1000	262	200	172	294	595	20,6	47240
Type 115 with G-TEC grating, black, KTL-coated, locked	1000	262	115	95	150	595	19,3	47231

RECYFIX®PRO 200

RECYFIX®PRO 200, class D 400

Type 010 with G-TEC grating, KTL-coated, locked

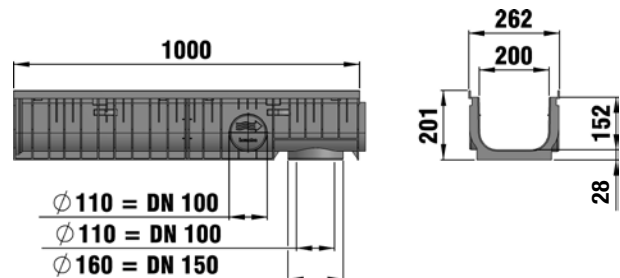

	Length mm	Width mm	Height mm	Invert mm	Drainage cross-sect. cm ²	Intake cross-sect. cm ² /m	Weight kg	Item No.
Type 010 with G-TEC grating, KTL-coated, locked	1000	262	200	172	294	595	20,6	47245
Type 115 with G-TEC grating, KTL-coated, locked	1000	262	115	95	150	595	19,3	47232
Type 010 with ductile iron grating METROPOLIS, black, KTL coated, locked	1000	262	200	172	294	279	23,8	47272
Type 01005 with ductile iron grating METROPOLIS, black, KTL coated, locked	500	262	200	172	294	279	12,3	47273
Type 115 with ductile iron grating METROPOLIS, black, KTL coated, locked	1000	262	115	95	150	279	23,8	47271



Retail Park, Abbeywood, Bristol



BEDE College Sunderland

RECYFIX® PRO 200

Accessories

Trash boxes



Trash box with galvanised mud bucket and FIBRETEC Slotted grating, black, cl. B 125, locked

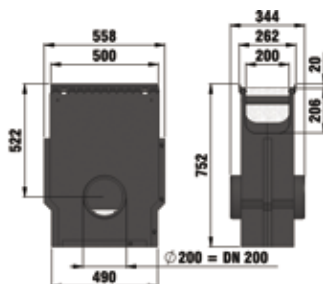

	Length mm	Width mm	Height mm	Weight kg	Item No.
Trash box with galvanised mud bucket and FIBRETEC Slotted grating, black, cl. B 125, locked	500	262	752	29,2	47253
Trash box with galvanised mud bucket and longitudinal ductile iron grating, KTL, cl. C 250, locked	500	262	752	36,2	47254
Trash box with galvanised mud bucket and mesh grating MW 30 30. cl. B 125, locked	500	262	752	36,2	47256
Trash box with galvanised mud bucket and G-TEC grating, cl. C 250, locked	500	262	752	36,4	47252
Trash box with galvanised mud bucket and G-TEC Ductile iron grating, black, cl. D 400, locked	500	262	752	35,4	47255
Trash Box with PE mud bucket and ductile iron design grating METROPOLIS, black, KTL, coated, D 400 locked	500	262	752	37,2	47278

End caps

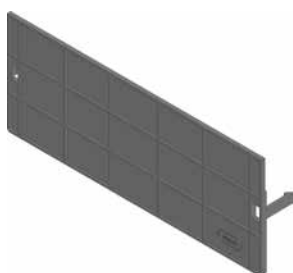

End cap closed, type 115

	Length mm	Width mm	Height mm	Weight kg	Item No.
End cap combined closed / with outlet DN 100, Type 010	-	258	217	0,2	41387
End cap closed, type 115	-	250	100	0,1	47297

RECYFIX® PRO 200

Further accessories



Foul air trap, vertical, DN 100



Mud bucket DN 150

	Length mm	Width mm	Height mm	Weight kg	Item No.
Foul air trap, vertical, DN 100	-	187	181	0,6	40295
Mud bucket DN 150	-	-	180	0,6	2191



RECYFIX®PRO 300

Combi article

RECYFIX®PRO 300, class C 250

Type 010 with G-TEC grating, KTL, 8-fold bolted

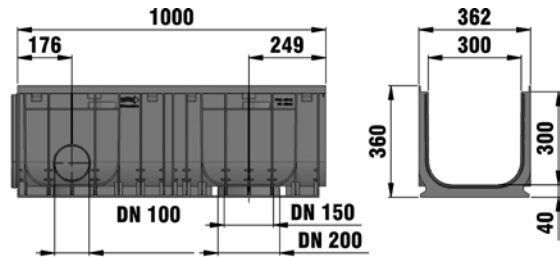

	Length mm	Width mm	Height mm	Invert mm	Drainage cross-sect. cm ²	Intake cross-sect. cm ² /m	Weight kg	Item No.
Type 010 with G-TEC grating, KTL, 8-fold bolted	1000	362	360	320	873	960	38,1	49744

RECYFIX®PRO 300, class D 400

Type 010 with G-TEC grating, KTL, 8-fold bolted

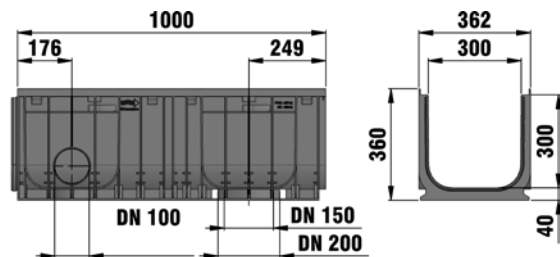

	Length mm	Width mm	Height mm	Invert mm	Drainage cross-sect. cm ²	Intake cross-sect. cm ² /m	Weight kg	Item No.
Type 010 with G-TEC grating, KTL, 8-fold bolted	1000	362	360	320	873	960	38,1	49745

RECYFIX® PRO 300

Accessories

End caps



End cap closed, galvanised, type 010



End cap with horizontal UPVC-outlet DN 200, galvanised, Type 010

	Length mm	Width mm	Height mm	Weight kg	Item No.
End cap closed, galvanised, type 010	-	360	360	1,9	49783
End cap with horizontal UPVC-outlet DN 200, galvanised, Type 010	-	360	360	2,6	49791





03/2018 |
All drawings, measurements and weights
are non-committal! We reserve the right to
do technical changes for improvement

HAURATON LIMITED

Unit 4, Frenchs Avenue
Dunstable, Bedfordshire
LU6 1BH
Tel. 01582 501380
Fax 01582 501399
technical@hauraton.co.uk
www.hauraton.co.uk

