



GRASPOINTNER  
Sustainable innovation.



According to Austrian standard B2506-3

The new FILCOTEN<sup>®</sup> green:

# The evolution of the revolution.

 **FILCOTEN<sup>®</sup>**  
green

The line drainage system  
with technical filter.

# When old strengths meet the latest technology.

Can you make a great revolutionary product even better? Can an extremely environmentally-friendly drainage channel be even more ecological? Yes, it can – and the new FILCOTEN® green can prove it.

## Even more efficient filtering of drainage water.

We have optimized the integrated technical filter even further based on intensive research and development. According to Austrian Standard B2506-3, the new FILCOTEN® green now rids the surface water of pollutants more efficiently than ever. Thanks to this, the water cycle is protected with a lasting effect.

## The perfect combination of drainage and retention

With a new nominal width of 400 mm as well as an optimized drainage channel, the channel's drainage and retention capacities have been considerably increased. Sustainability and efficiency in perfect harmony

### Cast iron grating

Available in classes  
C250 and E600

### Innovative, extremely high-performing filter unit

- High-performing "ViaSorp" filter material
- Prefilter fleece ensures thorough preclearing
- According to Austrian Standard B2506-3
- Trapezoid-shaped perforated sheet metal made from stainless steel for optimized water flow and retention of the filter material

### End plate

- End cap with outlet DN 150
- Forwarding of the water to the sewer system or receiving waters
- Made from stainless steel

### Optimized drainage channel with a nominal width of 400 mm

- Increased drainage capacities
- Larger retention volume



### Bolted gratings

- 4-point-bolting per grating for max. safety
- Integrated pins to prevent longitudinal shifting
- Easy to maintain thanks to exchangeable bolting
- Grating C250 with rapid locking system

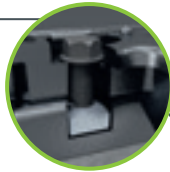

### Robust drainage channel made from high strength FILCOTEN<sup>®</sup> HPC (High Performance Concrete)

- Integrated cast iron edges, KTL-coated
- Lateral anchoring recesses for strong and durable retain in the foundation concrete
- Smooth sidewalls for perfect fit of pavement

up to class E 600

### Front plate

- Front end cap made from stainless steel

### New two-meter construction length

- Fewer butt joints
- More efficient installation of the channel runs

Areas of application:  
Wherever cleaning is just not enough.

The new FILCOTEN<sup>®</sup> green is suitable for use wherever you need to purify surface water, for example:

- Commercial buildings
- Car parks
- Logistics centers
- Residential buildings with multiple car parks
- Houses with zinc or copper roofs

### Floor drain up to DN 200

- Innovative construction
- Efficient feed of the water into the sewage system or an infiltration system

# We are setting a new **purity standard** for surface water

The new FILCOTEN® green features an innovative filter system, enabling superior cleaning performance. At the same time, the system is easy to install and maintain.

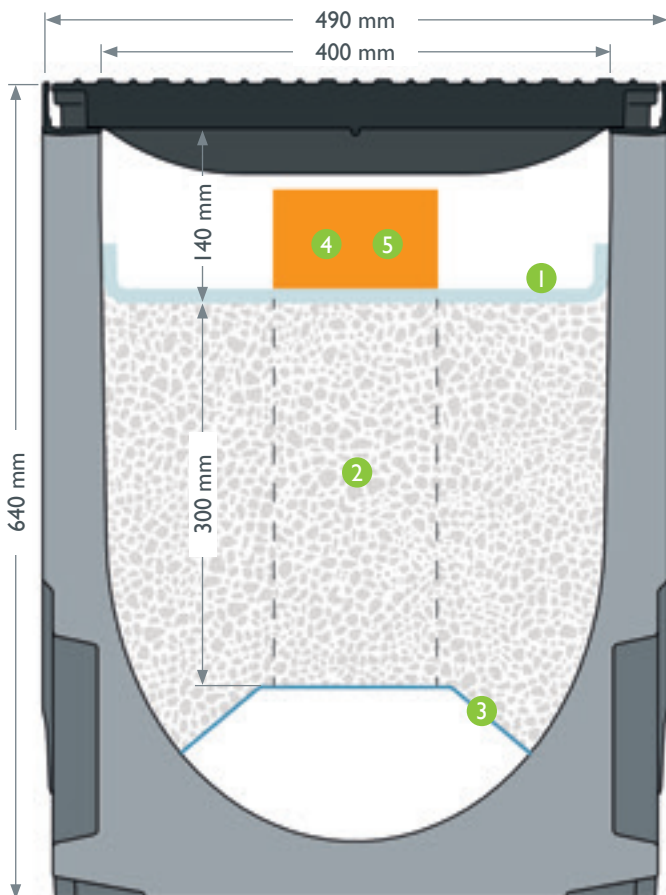

## 1 Pre-filter fleece for efficient preclearing.

- Pre-filter fleece keeps out coarse dirt, protecting the high-quality technical filter material
- very easy to install, maintain and replace

## 2 Powerful integrated technical filter.

- diverse applications: Thanks to a tested surface ratio of 1:250 and origin classes A, B and C (in accordance with Austrian standard B2506-3), the filter is suitable for paved surfaces as well as zinc and copper roofs
- excellent efficiency as well as high and lasting cleaning performance

## 2 Innovative cleaning filter material.

- filter substrate in optimized quantity type ViaSorp (300 mm height)
- highest cleaning performance class
- **in accordance with ÖWAV RB45 and tested according to Austrian standard B2506-3**
- homogeneous material, no segregation during use
- no risk of remobilizing heavy metals due to surface water with dissolved de-icing salts

## 3 Trapezoid-shaped perforated sheet metal made from stainless steel.

- separates the filter substrate zone from the drainage area, keeping the transverse drainage section permanently clear
- optimized perforated surface for maximum drain of water

## Increased filter, retention and connection surfaces

- New nominal width of 400 mm – **33% more filter surface** per running meter
- Clearly lower channel run lengths
- Height of 640 mm allows for larger connection surfaces as well as **higher-performing retention**

Connection surfaces per running meter, according to rain intensity:

Connectable surfaces [m <sup>2</sup> ]	Rain intensity [l/s*Ha]
87	150
65	200
52	250
43	300
37	350

*We would be happy to provide you with an exact hydraulic calculation based on the local area in which you intend to install the channel.*

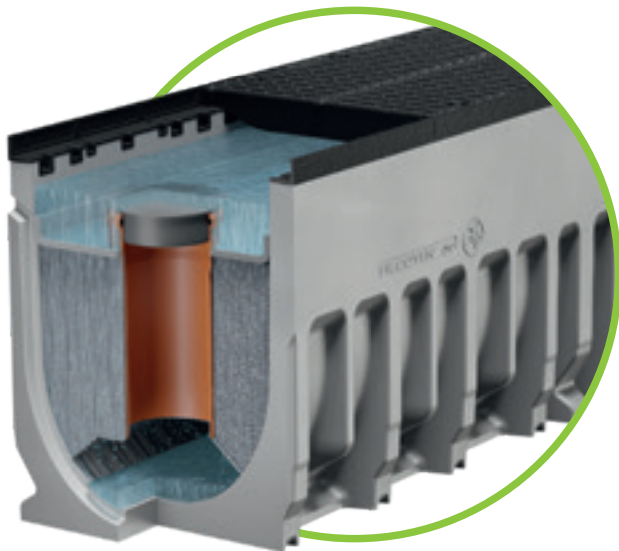
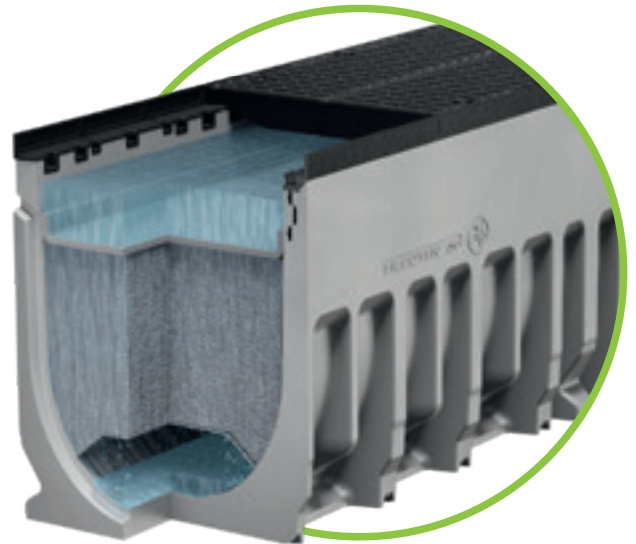

### 4 integrated Control & water sampling shaft.

- control/ water abstraction shaft for visual control and sampling
- easiest handling: remove grating, open cover and draw a purified water sample
- purified water can be collected and tested as to its components – **in accordance with ÖWAV RB45 and Austrian standard B2506**

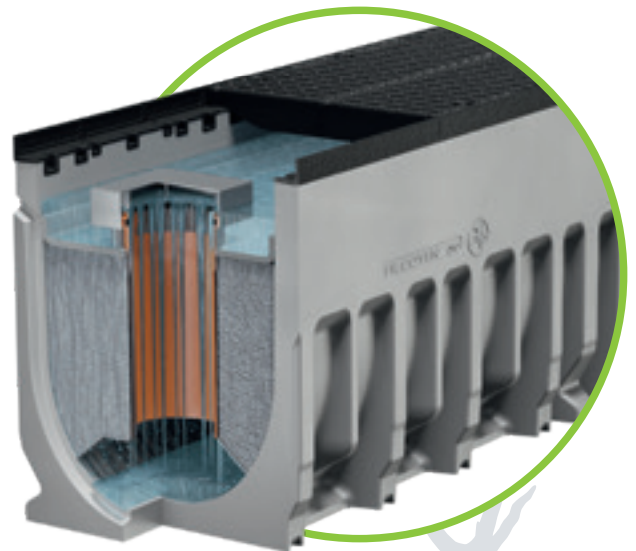

### 5 Innovative overflow DN150 for efficient heavy rain drainage.

- effective protection even in most extreme rainfall
- cleaning of polluted first flush via the technical filter
- unpolluted excess water can drain out through the overflow pipe in a controlled way
- **ATTENTION:** Approval of the authority must be given for this device.



## FILCOTEN® green incl. cast iron edge, NW 400

Channel made of FILCOTEN® HPC (High Performance Concrete) with integrated cast iron edge up to cl. E

Item no.	Channel body with cast iron edges and safety joint	Slope	Weight	Pc./pallet
10640166	FILCOTEN green G NW 400, no. 30-0, L= 2000 mm	0,0 %	287 kg	1
10641166	FILCOTEN green G NW 400, no. 30-0, L= 1000 mm	0,0 %	145 kg	1
30002	Additional charge for channels with outlet DN 200			



## Gratings

for FILCOTEN® green with integrated cast iron edge, nominal width 400

Item no.	4 point bolted gratings	Load class	Weight	Pc./pallet
17040182	green ductile iron slotted grating 500/474/35, SW 18/220 <sup>4+5)</sup>	C 250 kN	19,9 kg	20
17040181	green ductile iron slotted grating 500/474/35, SW 18/220 <sup>4)</sup>	E 600 kN	28,2 kg	20
32110	green locking device kit for ductile iron slotted gratings (1 set = bolt+nut - 8 sets required per m)			
32122	green locking device kit V2A for ductile iron slotted gratings (1 set = bolt+nut - 8 sets required per m)			

<sup>4)</sup> Locking device kit to be ordered separately

<sup>5)</sup> In Standard with self-locking system

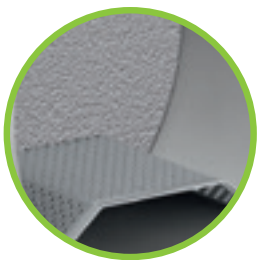

## Accessories

Sets of filter unit, front- /end caps, locking device kits (bolting)

Item no.	Accessories	Material	Weight
19540950	<u>complete filter unit per m</u> : consisting of: trapezoid perforated sheet metal, ViaSorp filter material, BG prefiltermat	<b>Required:</b> 1 Set/m channel	114 kg
19540910	green prefiltermat, L = 5000 mm, W = 500 mm		0,88 kg
19500900	green ViaSorp filter material, approved acc. to Austrian standard B2506-3, Big Bag 1000 kg		1000 kg
19500901	green ViaSorp filter material, approved acc. to Austrian standard B2506-3, Big Bag 850 kg		850 kg
19040360	green trapezoid perforated sheet metal, L = 2000 mm	stainl. steel V2A	7,6 kg
19040361	green trapezoid perforated sheet metal, L = 1000 mm	stainl. steel V2A	3,8 kg
19040362	green trapezoid perforated sheet metal with outlet DN 150, L = 2000 mm (for overflow-pipe or water sampling pipe)	stainl. steel V2A	7,4 kg
19040364	green trapezoid perforated sheet metal with outlet DN 150, L = 1000 mm (for overflow-pipe or water sampling pipe)	stainl. steel V2A	3,6 kg
19540952	green overflow-pipe DN 150 (pipe+overflow-cover)		
19540953	green water sampling pipe incl. plug connection		
19040353	green partition sheet NW 400	stainl. steel V2A	1,85 kg
19040350	green front- /end cap	stainl. steel V2A	3,4 kg
19040351	green end cap with outlet DN 150	stainl. steel V2A	4,4 kg

Is a joint sealing profile required? Please contact our Customer Service.

Sustainable in every respect,  
high-performance down to the last fiber –  
or simply FILCOTEN®.



Sustainability and innovation are the key components of our company culture. This is reflected in the materials we use for our products and our manufacturing processes.

**The result: Cutting-edge technology in harmony with nature.**

### Sustainability<sup>3</sup> – from the manufacturer, to the materials used, right up to the application.

The new FILCOTEN® green represents these strengths like no other product. It combines resource-friendly manufacturing processes with sustainable materials and extraordinary water-cleaning performance. Keeping the environment in mind – right from the start.

### Mineral raw material, recyclable and energy-efficient.

FILCOTEN® HPC (High Performance Concrete) is a mineral material which is 100% recyclable and free from synthetic resins and solvents. When it comes to our production, we rely on an environmentally friendly energy mix for production and avoid using fossil fuels to the greatest extent possible.

### Environmentally friendly production process.

We also focus on environmental protection for the production process – in the choice of raw materials and by avoiding excessive waste. On that note, we have implemented an environmental management system in accordance with the ISO standard 14001.

### Material with excellent properties.

- FILCOTEN® HPC (High Performance Concrete)
- Cement-bonded, mineral material with high bending tensile strength thanks to fiber reinforcement
- Up to 70% lighter than conventional concrete channels
- Temperature, frost and UV-resistant
- Resistant to rust, oil and petrol
- Coefficient of expansion matches the mineral environment
- Long-lasting pleasant appearance

### BG-energy mix:

80,06 %	Hydroelectric power
9,57 %	solid or liquid biomass
8,48 %	Wind power
1,89 %	Other green energy
100 %	Sustainable energy footprint.

As of 2016

### Certified: non-toxic.

- Meets the strict criteria of the Rosenheim Institute for Building Biology (IBR)
- Protects health and the environment
- Guaranteed to be ecologically safe as it is tested for biocides, solvents, VOC, heavy metals and radioactivity



## Drainage channel installation guidelines

### with an outlet into the sewage or infiltration system

The installation guidelines and installation examples below are intended for standard applications. The load class and installation site must be adjusted to the local conditions of the planned site in accordance with EN 1433. The technical rules and guidelines that are generally known among experts must be taken into account during the installation.

#### 1 Connection to sewage pipes:

The BG concrete channels must be installed on a concrete foundation in accordance with Austrian standard B4710-1, or in single grain concrete in accordance with RVS 08.18.01. Depending on the static requirements, a lateral support wedge may be required – see installation details or ask the BG application technicians. The channel elements should only be installed with suitable tools (e.g. BG laying clamp).

#### 2 Infiltration beneath the channel:

The layers of the floor beneath the channel must meet infiltration requirements. The BG concrete channels are installed on a correspondingly dimensioned gravel bed in a concrete foundation in accordance with Austrian standard B4710-1, or in single grain concrete according to RVS 08.18.01. The outlet opening must be exposed (e.g. with DN150 Polokal pipes). Depending on the static requirements, a lateral support wedge may be required. See installation details or ask the BG application technicians. The channel elements should only be installed with suitable tools (e.g. BG laying clamp).

#### 3 Begin by laying the channel runs from the junction to the outlet. The flow direction on each channel is indicated with an arrow.

#### 4 The butt joints between the individual drainage channels must be sealed with a suitable sealant or glued. See the BG seal system for material descriptions and quantity determination.

#### 5 Before the manufacturing of the adjacent ground cover, lay the covers and, if necessary, secure or reinforce the channels so that they do not push against each other. When sealing the upper structure and surface layer (asphalt, pavement, concrete, etc.), ensure that the channels are not damaged.

#### 6 For any arising horizontal forces (e.g. concrete surfaces, gradients, etc.), an adequately dimensioned expansion joint needs to be placed at a distance of 30-200 cm to the channel in the area of the channel connection. The expansion joints running perpendicular to the channel runs must be arranged so that they can run through a channel butt joint.

#### 7 For installation application in heavily frequented areas, we recommend securing the cover with “fiX” fasteners or screws (max. tightening torque of 40 Nm) depending on the area of application and the frequency and speed of crossing.

#### 8 All adjacent cover layers should always be installed 3-5 mm above the upper surface of the channel in order to avoid mechanical damage (e.g. through snow removal) and ensure draining of the water.

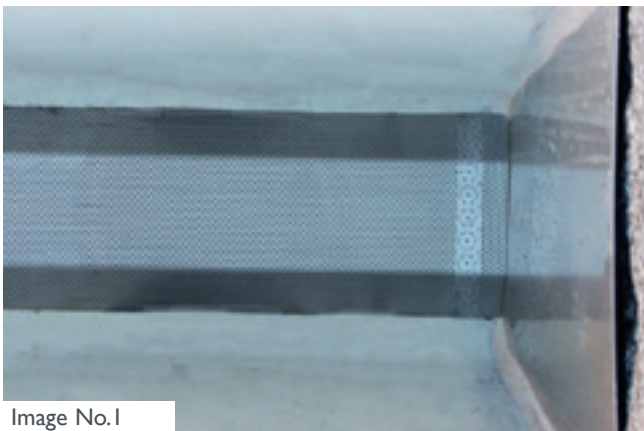

Image No. 1

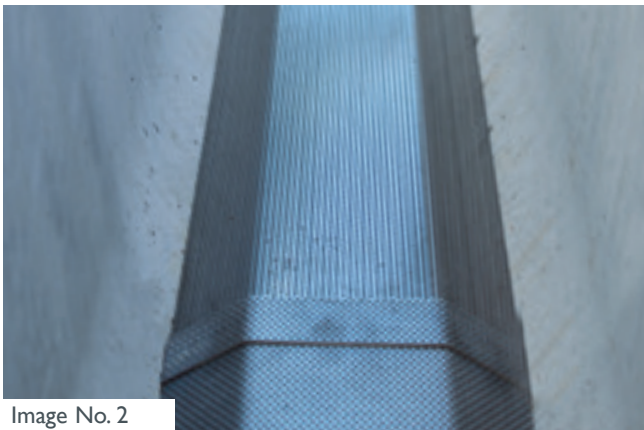

Image No. 2

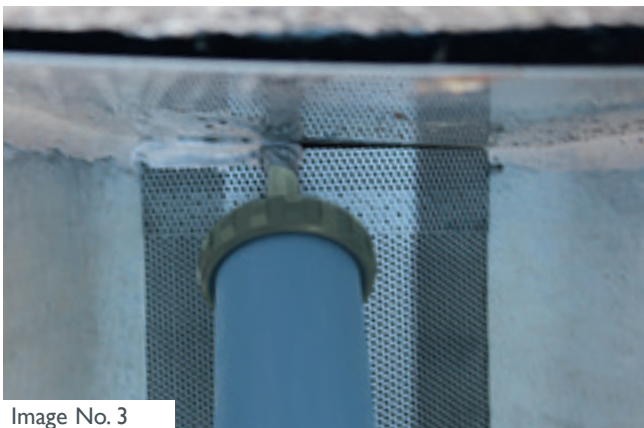

Image No. 3



### Technical filter in accordance with Austrian standard B 256-3

- 1** After the installation of the FILCOTEN<sup>®</sup> green channels in accordance with the standards (see previous paragraph), the trapezoid perforated plate is inserted (image 1). The protruding end of the trapezoid perforated sheet (transfer) must be butt-joined with the front side (end plate of the channel). Afterwards, the next sheet with the transfer is placed on the first plate – care must be taken to ensure that they overlap correctly (image 2).
- 2** Afterwards, the trapezoid perforated sheet must be sealed to the front-end plate (image 3).
- 3** The filter material is placed in the channel using a “big bag”. There is a recloseable filling hose on the bottom of the “big bag” (image 4).
- 4** The correct height, i.e. the correct filter thickness of 30 cm, can be achieved (image 5) by using the tool supplied to smooth the filter material.
- 5** The prefilter is placed on the filter material with the denser side facing down (marked with an “U”) and pulled up on the side walls (image 6).
- 6** The cast iron gratings are inserted to the installed channels and 4-point bolted (image 7).



Image No. 4



Image No. 5



Image No. 6



Image No. 7

## Cleaning & maintenance guidelines



The filter capacity and the retention of material can only be ensured in the long-term if the system is maintained according to the following guidelines.

The drainage system must undergo a visual inspection after every period of heavy rainfall, or at least every six months. If the prefilter-mat is heavily contaminated, to the point where there is overflow in the channels, we recommend that you replace it or, if necessary, clean as follows:

- Close off the work area in accordance with applicable safety regulations.
- Remove the covering from the channels and place to the side.
- Start to remove the prefilters from one side and collect the dirt in a suitable container (shake out, beat, rinse off by placing it in the water against the flow direction, ...) – afterwards these residues must be disposed of professionally and in line with regulations.
- If the prefilters are extremely silted, we recommend replacing them – request replacements from BG-Graspointner.
- The thickness of the filter material can be checked with the flattening device.
- If the filter thickness is less than 30 cm, it has to be filled up with new filter material up to the correct thickness.
- The cleaned prefilter must be placed on the filter material with the “U”-side facing down and pulled up on the sides.
- With the re-assembly of the cover, care must be taken to ensure that covers and frames are free from contamination so that the converse rest entirely on the frames.
- Lay and screw-in the covers in accordance with point 3 of these guidelines.



*Legal provisions arising from the water authority approval must be observed by the operator.*

### Water sample & filter material test

A water sample or filter material test in accordance with official requirements (water regulations) must be performed regularly by the operator of the water treatment system.

If replacements are required, only original “ViaSorp” filter material by BG-Graspointner can be used. This must be handled and inserted according to current installation instructions.

The removed filter material must be disposed of by a specialized company – e.g. sewer cleaning service – in accordance with applicable legal guidelines.

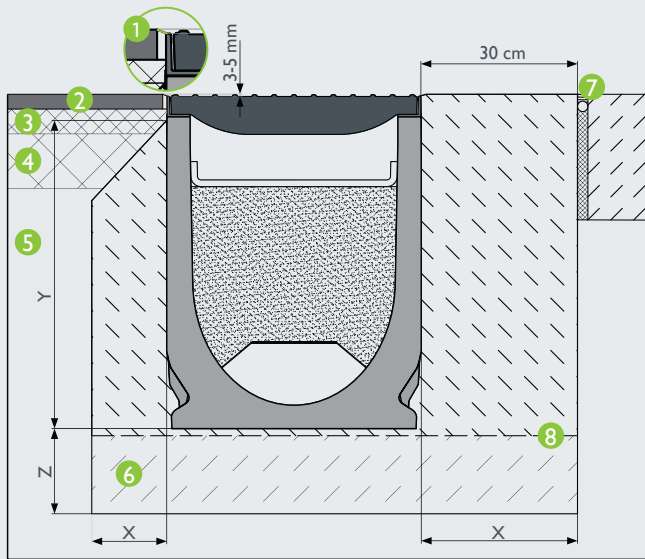

- 1 bituminous sealing tape
- 2 cover layer
- 3 bitumen gravel
- 4 load-bearing bitumen layer
- 5 load-bearing gravel layer
- 6 concrete foundation acc. to static calculations
- 7 expansion joint
- 8 working joint

load class	B 125 kN	C 250 kN	D 400 kN	E 600 kN
concrete quality acc. to Ö-Norm B4710-1*	C 20/25	C 20/25	C 25/30	C 25/30
width: X	≥ 10 cm	≥ 15 cm	≥ 30 cm	≥ 30 cm
height: Y	channel height - 5 cm		channel height	
thickness: Z	≥ 10 cm	≥ 15 cm	≥ 20 cm	≥ 20 cm
reinforcement	unnecessary			acc. to static calc.

\* Concrete quality is a minimum requirement and has to be adapted to the local conditions.

The installation drawings are generally applicable examples. Details and further information can be found on our homepage [www.graspointher.at](http://www.graspointher.at). For unusual installation situations, you can also contact our application technicians directly.

**i** **ATTENTION:** Forces resulting from starting, braking and turning heavy vehicles must be taken into consideration separately. Please observe installation instructions. Subject to technical modifications.



Certified according Austrian standard



**GRASPOINTNER**  
Sustainable innovation.

BG-Graspointner GmbH  
Gessenschwandt 39  
4882 Oberwang  
AUSTRIA

Tel.: +43 6233/89 00-0  
Fax: +43 6233/89 00-303

E-Mail: [office@graspointner.at](mailto:office@graspointner.at)  
Web: [www.graspointner.at](http://www.graspointner.at)



Innovation & environmental awareness  
also apply for our print products.

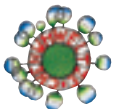

Printed according to criteria documents of the austrian Eco-Label  
„printed products“. gugler®print, Melk, UWZ-Nr. 609, [www.gugler.at](http://www.gugler.at)



This paper comes from  
sustainably managed forests and  
controlled sources.  
[www.pefc.at](http://www.pefc.at)

**greenprint\***  
carbon positive printed

\* Our contribution to the reforestation project of BOKU Wien in Ethiopia.

Your partner for BG-Graspointner drainage systems.