

Ecophon Master™ Ds

Ecophon Master™ Ds has a concealed grid and symmetrical edge design, allowing for easy assembly, and integration of light fittings and ventilation. For applications where a suspended ceiling with a concealed grid is required, but individual tiles must be easily demountable.



Hoaga-Hella Campus, Germany

SYSTEM RANGE

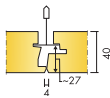

Size, mm	600x600
T24	•
Thickness	40
Inst. Diag.	M626, M627, M628

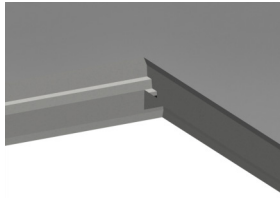

Master Ds tile

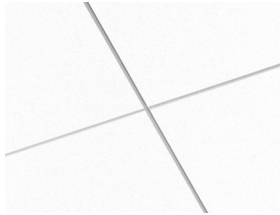

Master Ds system

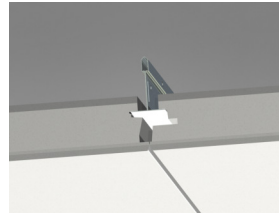

Section of Master Ds system.

Acoustic



Sound Absorption:

Test results according to EN ISO 354. Classification according to EN ISO 11654, and the single value ratings for Noise Reduction Coefficient, NRC and Sound Absorption Average, SAA according to ASTM C 423.

α_p , Practical sound absorption coefficient

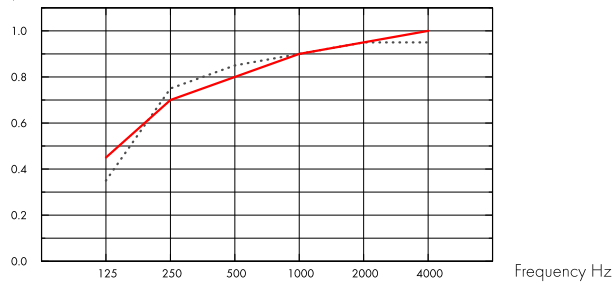

..... Master Ds 40 mm, 95 mm o.d.s.
 — Master Ds 40 mm, 200 mm o.d.s.
 o.d.s = overall depth of system

THK mm	o.d.s. mm	α_p , Practical sound absorption coefficient						α_w	Sound absorption class
		125 Hz	250 Hz	500 Hz	1000 Hz	2000 Hz	4000 Hz		
40	95	0.35	0.75	0.85	0.90	0.95	0.95	0.90	A
40	200	0.45	0.70	0.80	0.90	0.95	1.00	0.90	A

THK mm	o.d.s. mm	NRC	SAA
40	95	0.90	0.91
40	400	0.85	0.86

THK mm	AC(1.5) Articulation Class, ASTM E1111, ASTM E1110	D_{nfw} Weighted normalized flanking level difference, ISO 10848-2	CAC dB Ceiling Attenuation Class, ASTM 1414, ASTM E413
40	200	31	33

Indoor Air Quality



Certificate / Label	All Products
Eurofins Indoor Air Comfort®	IAC Gold
French VOC	A+
Finnish M1	•



Cradle to Cradle Certified®



This product is Cradle to Cradle Certified® at Bronze level (version 4.0).



Material Health

This product has received a C2C Certified Material Health Certificate™ at the Silver level (standard version 4.0). The C2C Certified Material Health Certificate™ is a verification of the health and safety of a product's composition using the Material Health requirements of the Cradle-to-Cradle Certified Product Standard.



Environmental Footprint

kg CO ₂ equiv/m ²		Life-cycle stages A1 to C4 from EPD, in conformity with ISO 14025 / EN 15804
Master Ds	7,10	



Circularity

Minimum post-consumer recycled content	63%
Recyclability	Fully recyclable



Fire safety

Country	Fire standard	Class	The glass wool core of the tiles is tested and classified as non-combustible according to EN ISO 1182.
Europe	EN 13501-1	A2-s1,d0	



Humidity Resistance

Class C, relative humidity 95% and 30°C, according to EN 13964:2014



Visual appearance

White Frost, nearest NCS colour sample S 0500-N, 85% light reflectance. Gloss < 1.



Cleanability

Daily dusting and vacuum cleaning. Weekly wet wiping.



Accessibility

The tiles are easily demountable. Minimum demounting depth according to installation diagrams.



Installation

Installed according to installation diagrams, installation guides and drawing aid. For information regarding minimum overall depth of system see quantity specification. The systems are not recommended for small rooms (approximately 2x2 m²). Ceilings with a large amount of integrations require careful planning, design and installation.



System weight

The weight of the system (including suspension grid) should be approximately 6 kg/m².



Mechanical properties

See table about Max live load and Min load bearing capacity and Functional demands, Mechanical properties at www.ecophon.com.



CE

Ecophon ceiling systems are CE marked according to the European harmonized standard EN 13964:2014. CE marked construction products are covered by a Declaration of Performance (DOP) which enables customers and users to easily compare performance of products available on the European market.

INSTALLATION DIAGRAM (M626) FOR ECOPHON MASTER DS. SUSPENDED INSTALLATION

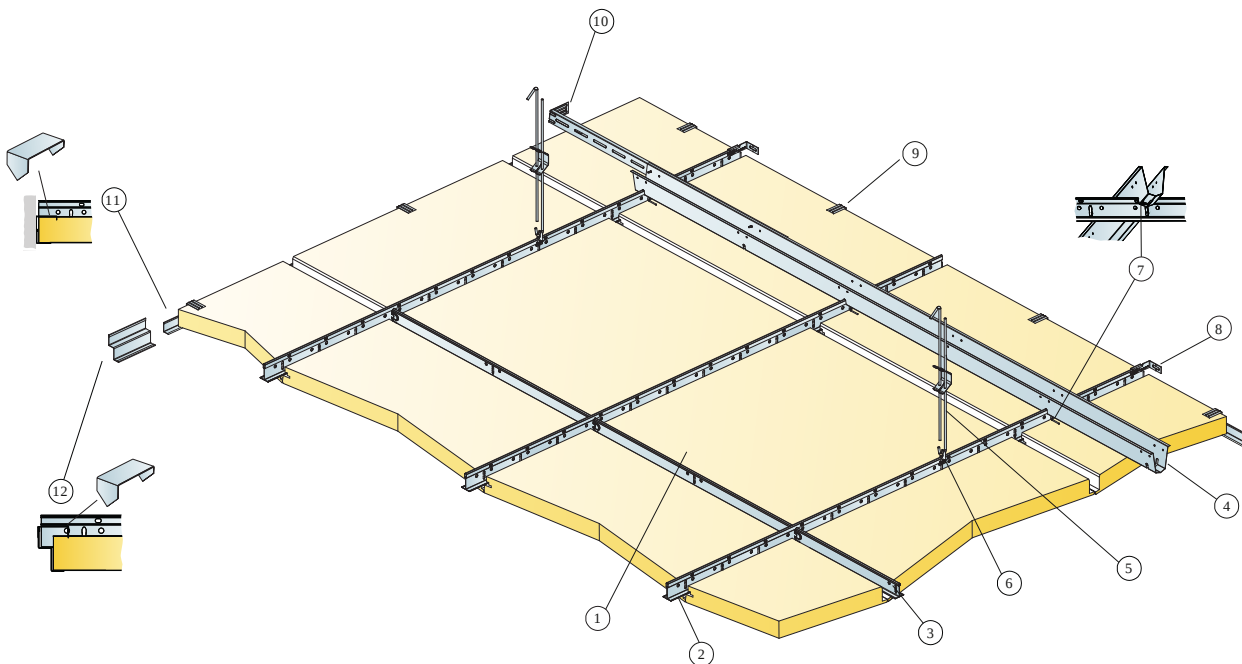

© Ecophon Group

QUANTITY SPECIFICATION (EXCL. WASTAGE)

	Size, mm
	600x600
1 Master Ds	2,8/m ²
2 Connect T24 Main Runner PL, installed at 600 mm centres	1,7m/m ²
3 Connect T24 Cross Tee, L=600 mm	2/row of Main runner
4 Connect Space Bar, installed at 1500 mm centres (max. distance from wall 300 mm)	0,7m/m ²
5 Connect Adjustable Hanger, installed at 1200 mm centres (max. distance from wall 600 mm)	0,7/m ²
6 Connect Hanger Clip (not to be used in swimming hall environments)	0,7/m ²
7 Connect Space Bar Winch, installed one per joint Connect Main Runner/Connect Space Bar	1,4/m ²
8 Connect Wall Bracket for T-profiles	1/suspended row of Main runner
9 Connect Perimeter tile clip 40	1/300-400mm on any cut edge
10 Connect Wall Bracket, L=700 mm, for Connect Space Bar	1/row of Space bar
11 Connect Angle Trim, fixed at 300 mm centres	as required
12 Connect Shadow-line Trim, fixed at 200 mm centres	as required
Δ Min. overall depth of system: 140 mm	-
δ Min. demounting depth: 50 mm	-
For luminaire integration in panels use Connect Bridging	-

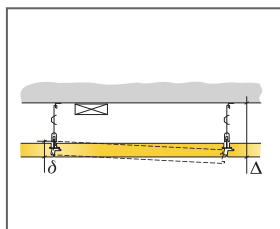

See Quantity Specification

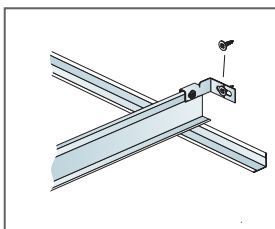

Connect Wall bracket for T-profiles

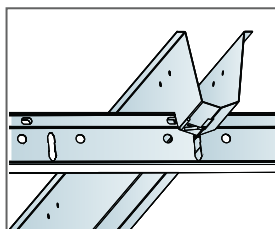

Size, mm	Max live load (N)	Min load bearing capacity (N)
600x600x40	20	160

Live load/load bearing capacity

INSTALLATION DIAGRAM (M627) FOR ECOPHON MASTER DS 600X600 MM. SUSPENDED INSTALLATION

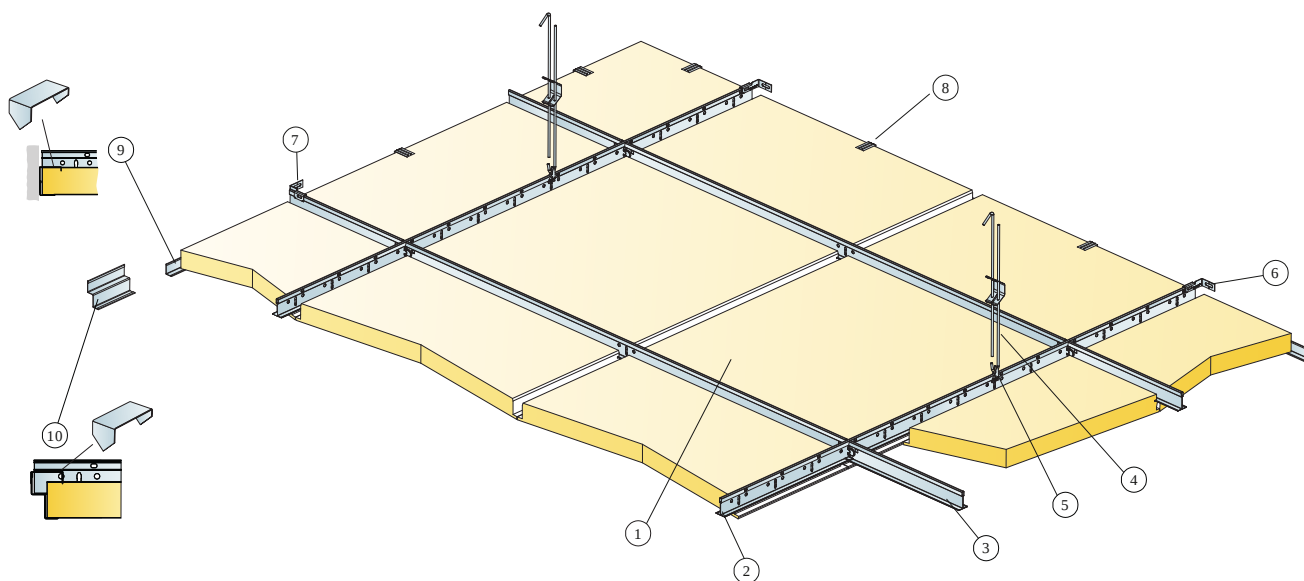

© Ecophon Group

QUANTITY SPECIFICATION (EXCL. WASTAGE)

	Size, mm
	600x600
1 Master Ds	2,8/m ²
2 Connect T24 Main Runner PL, installed at 1200 mm centres	0,9m/m ²
3 Connect T24 Cross Tee PL, L=1200 mm, installed at 600 mm centres	1,7m/m ²
4 Connect Adjustable Hanger, installed at 1200 mm centres (max. distance from wall 600 mm)	0,7/m ²
5 Connect Hanger Clip (not to be used in swimming hall environments)	0,7/m ²
6 Connect Wall Bracket, fixed 1200mm centres for Main runner	2/suspended row of Main runner
7 Connect Wall Bracket, fixed 1200mm centres for Cross tee	1/row of cross tee
8 Connect Perimeter tile clip 40	1/perimeter tile
9 Connect Angle Trim, fixed at 300 mm centres	as required
10 Connect Shadow-line Trim, fixed at 200 mm centres	as required
Δ Min. overall depth of system: 140 mm	-
δ Min. demounting depth: 50 mm	-
For luminaire integration in panels use Connect Bridging	-

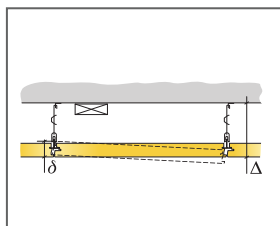

See Quantity Specification

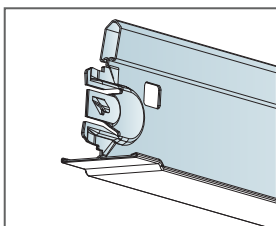

Cross tee PL

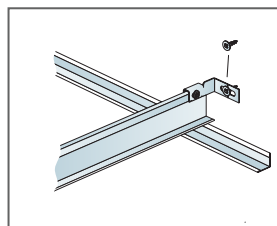

Connect Wall bracket for T-profiles

Size, mm	Max live load (N)	Min load bearing capacity (N)
600x600x40	35	160

Live load/load bearing capacity

INSTALLATION DIAGRAM (M628) FOR ECOPHON MASTER DS 600X600 MM. DIRECT INSTALLATION

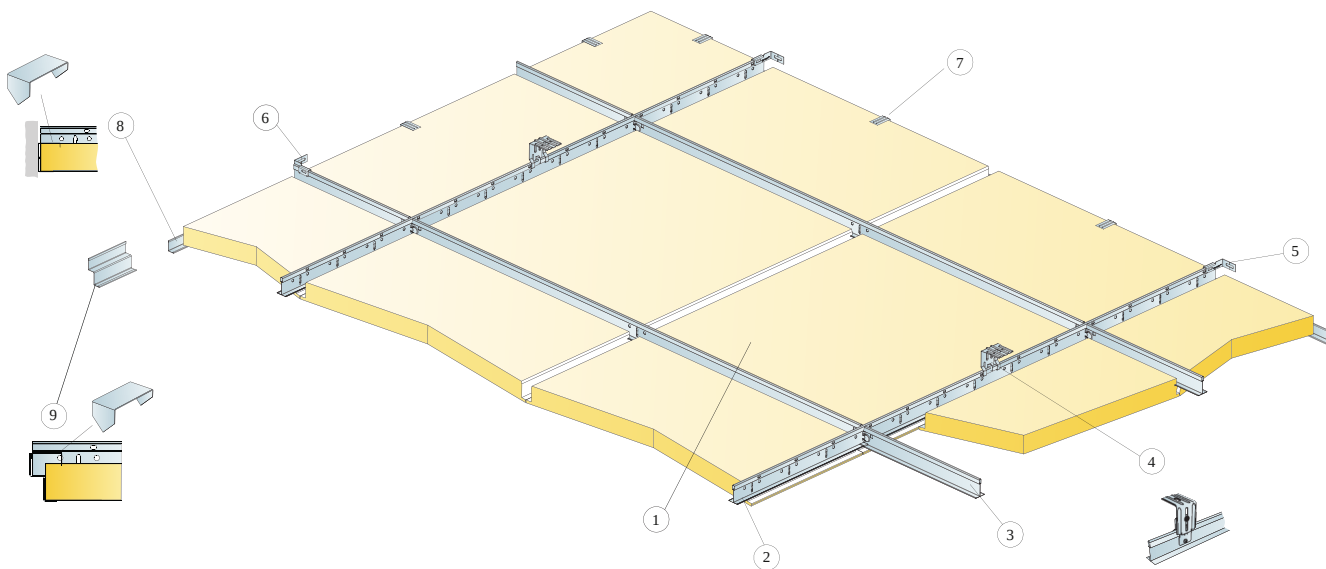

© Ecophon Group

QUANTITY SPECIFICATION (EXCL. WASTAGE)

	Size, mm
	600x600
1 Master Ds	2,8/m ²
2 Connect T24 Main Runner PL, installed at 1200 mm centres	0,9m/m ²
3 Connect T24 Cross Tee PL, L=1200 mm, installed at 600 mm centres	1,7m/m ²
4 Connect Adjust direct bracket, installed at 1200 mm centres	0,7/m ²
5 Connect Wall Bracket, fixed 1200mm centres for Main runner	2/suspended row of Main runner
6 Connect Wall Bracket, fixed 1200mm centres for Cross tee	1/row of cross tee
7 Connect Perimeter tile clip 40	1/perimeter tile
8 Connect Angle Trim, fixed at 300 mm centres	as required
9 Connect Shadow-line Trim, fixed at 200 mm centres	as required
Δ Min. overall depth of system: 95 mm	-
δ Min. demounting depth: 50 mm	-
For luminaire integration in panels use Connect Bridging	-

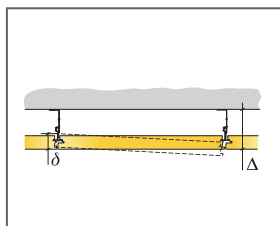

See Quantity Specification

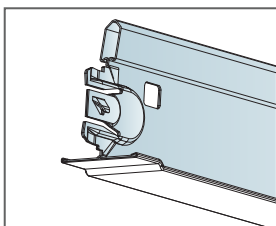

Cross tee PL

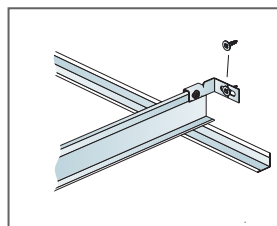

Connect Wall bracket for T-profiles

Size, mm	Max live load (N)	Min load bearing capacity (N)
600x600x40	35	160

Live load/load bearing capacity