



Shower Door Hinge

Juna



Perfect zero point adjustment thanks to patented clamping technology

Sophisticated technology meets first-class design

Developed and designed by Bohle, the new Juna shower door hinge combines aesthetics and functionality with quality and "Made in Germany" workmanship. Minimum gap dimensions and concealed screws emphasize the supreme quality of this swinging door hinge.

Juna also facilitates installation in many respects: The zero position adjusting screw is easily accessible and enables convenient adjustment.

The clamping screws and the zero position fixing screw have uniform screw heads which can be conveniently tightened with just one tool.

The centred mounting plate enables the optimum positioning of the cover cap. A stable plug connection guarantees its firm and precise fit.



 **100.000**
CYCLES TESTED

*Juna has been successfully tested for 100,000 swing door cycles by the ift Rosenheim. (DIN EN 14428:2005-02, section 5.5)

Tested to 100,000 cycles*

Minimum gap dimensions

Load capacity 50 kg per pair

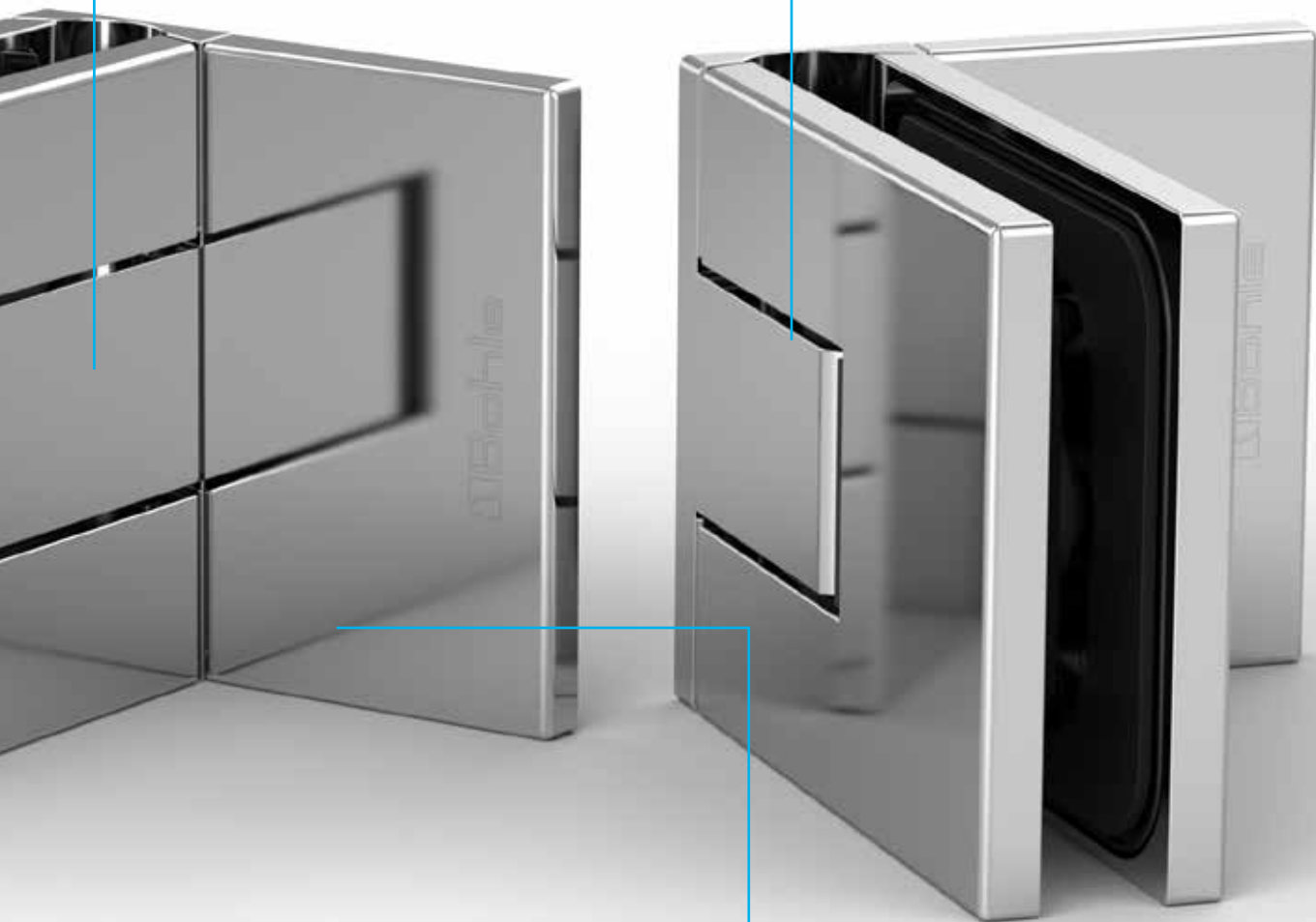

Supreme design with minimum gap dimensions

The bathroom is increasingly turning into a place of calm and relaxation. This results in a demand for modern design concepts and high-quality products and materials. Bohle has developed an innovative shower door hinge that inspires installers, builders and project planners alike.

The high-quality appearance of the shower door hinge immediately catches the attention. Minimum gap dimensions, no visible screws, even where the zero position adjustment is concerned, and a practically continuous sealing strip emphasize its classy look. Another feature is the above-average return angle of approx. 20° which closes the glass door automatically.

In addition, the material Juna is made of also reveals the high quality of the system. The high quality components made of brass and stainless steel in the inside of the hinge guarantee a long service life of the product. Comprehensive tests with 100,000 test cycles as per DIN 14428 prove the carrying capacity of the hinges of up to 50 kg.



5 YEAR
WARRANTY



Perfect zero position adjustment – innovative clamping technology

PATENTED
>ZERO< POSITION
ADJUSTMENT

Thanks to the innovative clamping technology, the hinge pin is not damaged by the locking screw. In contrast to standard locking screw adjusting hinges, the innovative technology enables the precise adjustment of the zero position down to the millimetre. Depending on the installation, a sealing profile is therefore not necessarily required.

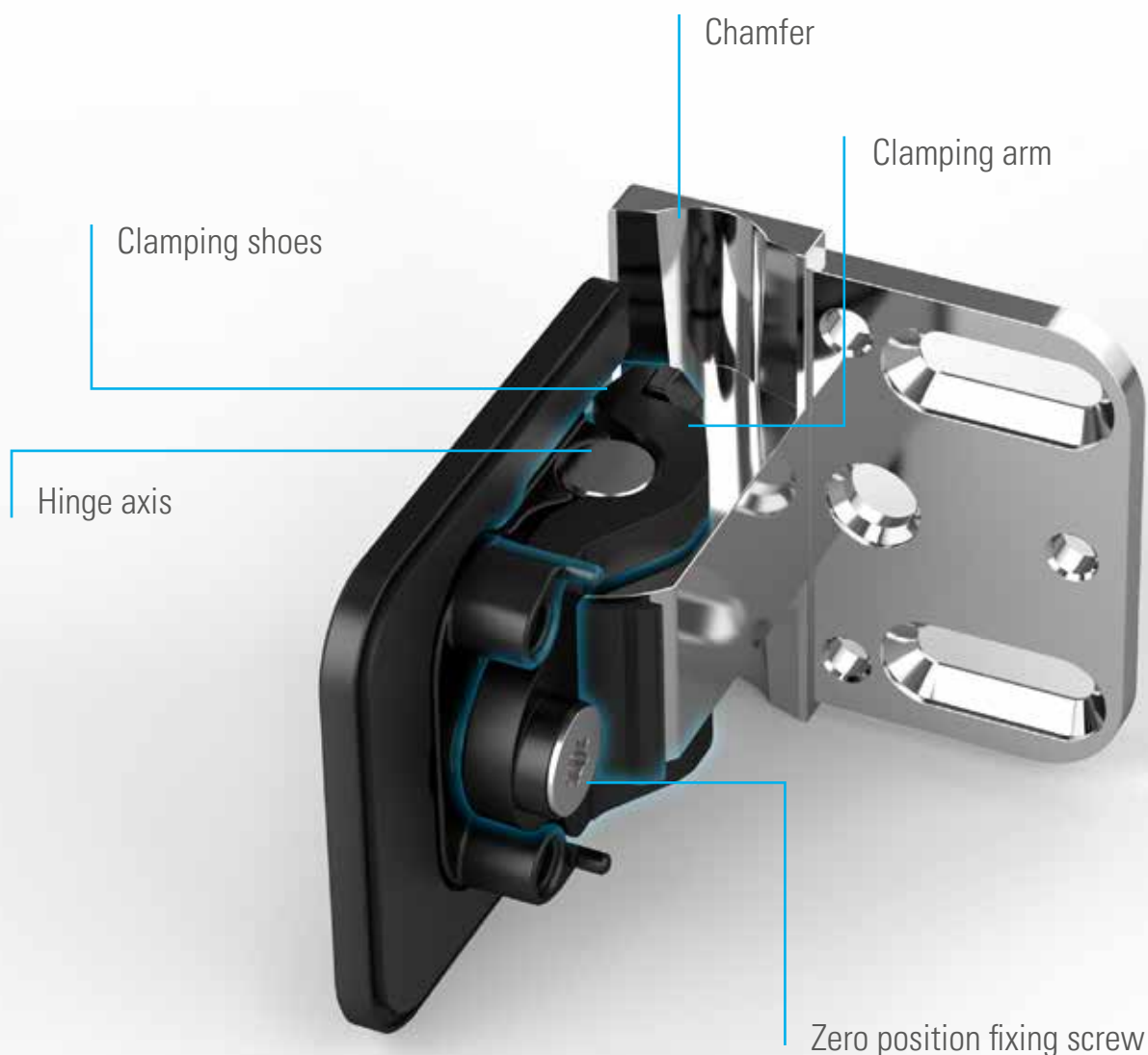

Efficient mounting with only one tool



Experience the
premium-
shower door hinge
Juna on YouTube

The clamping screws and the zero position fixing screw have uniform TX30 screw heads which can be conveniently tightened using only one tool. The troublesome exchange of tools while working is therefore a thing of the past. In addition, the elongated holes for the wall connection provide increased comfort when adjusting the hinge.

Two-part clamping plates also enable deeper threaded holes in the fitting and thus ensure a safe grip. At the same time, the hinge is protected against deformations on the outside.

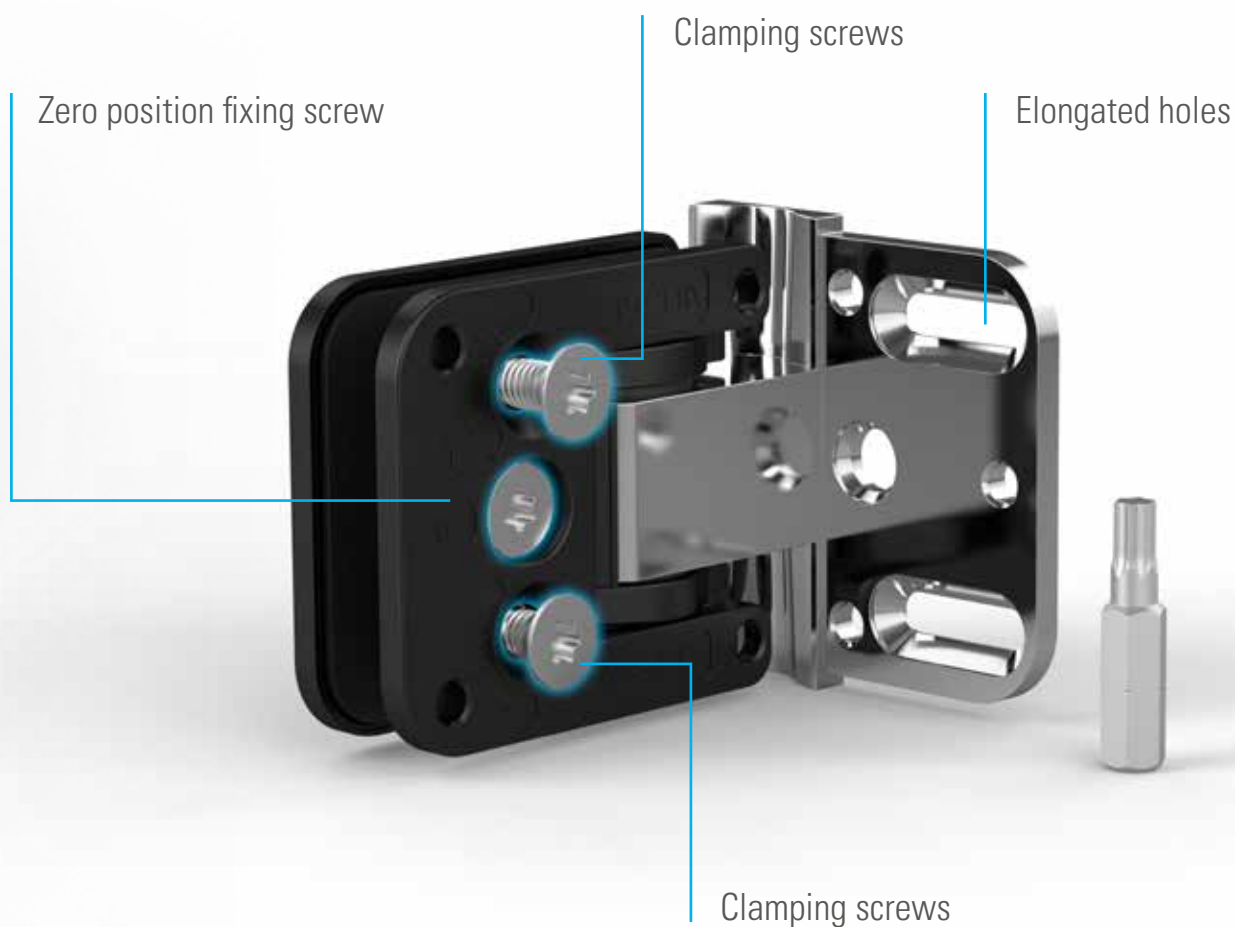

Precise fit of cover caps

QUALITY BY BOHLE

MADE IN GERMANY

The high quality design of Juna stands out thanks to its minimum gap dimensions. One of the prerequisites is the precise fit of the cover caps. For this purpose, Bohle has developed an innovative 4-point fixing mechanism which fixes the caps exactly in place.

This is made possible by four small centring pins and the tailor-made seating in the hinge. In addition, water resistant rubber rings provide additional hold. As a result, the cover caps are maintained in their exact position for years, without slipping.

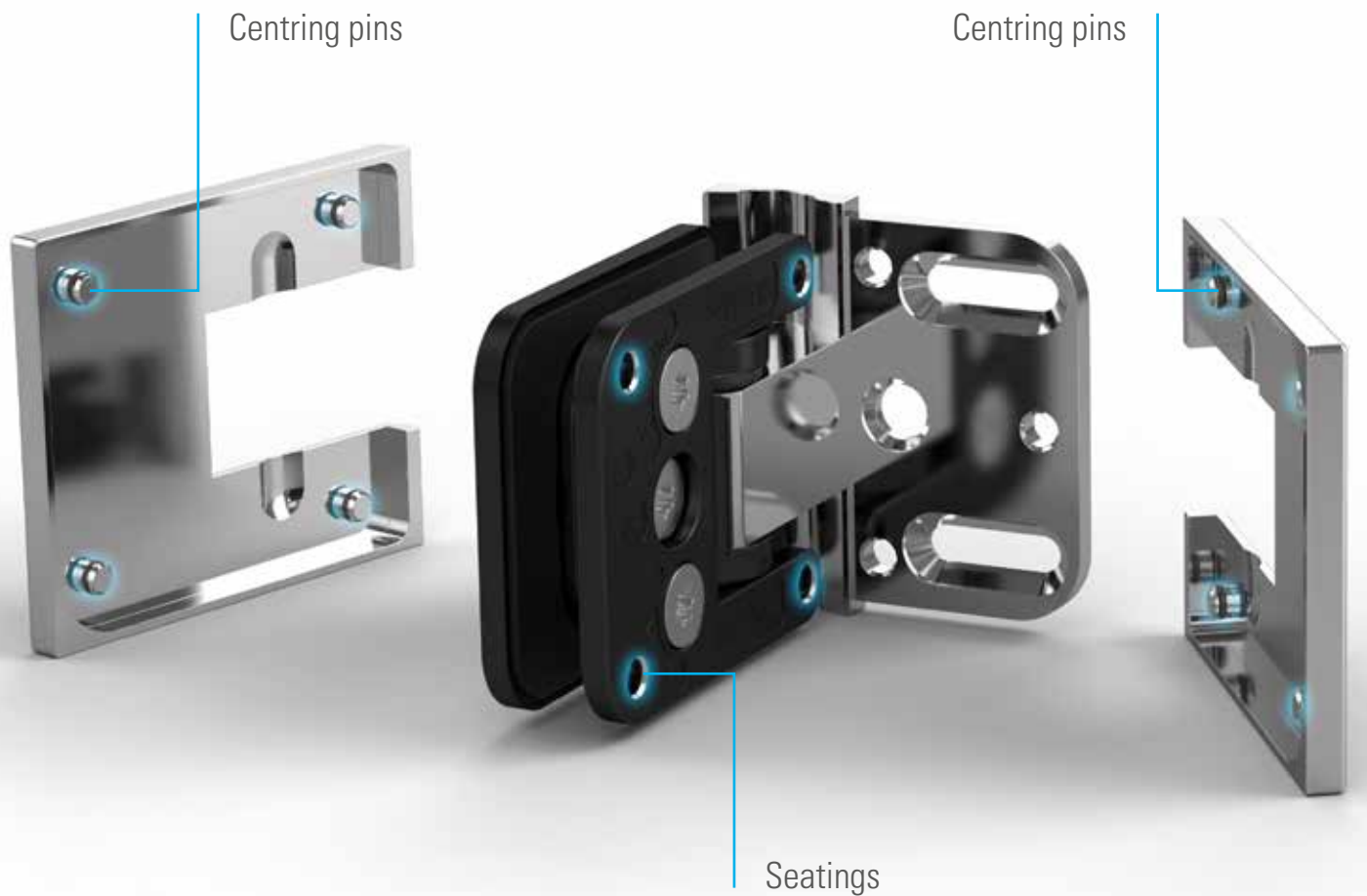

Sweat more beautifully with Juna[®]

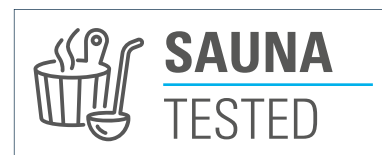

Our proven Juna[®] fitting is now also available for saunas. Create a uniform interior design by using the same hardware design for both your shower and your sauna door. Thanks to the high-quality materials, Juna[®] is resistant to moisture, corrosion and temperature fluctuations.

- For private sauna facilities (no steam or swimming pool)
- Maximum door size: 800 x 2000 mm with 8 mm glass thickness
- Only for swing doors
- Tested to 20,000 cycles

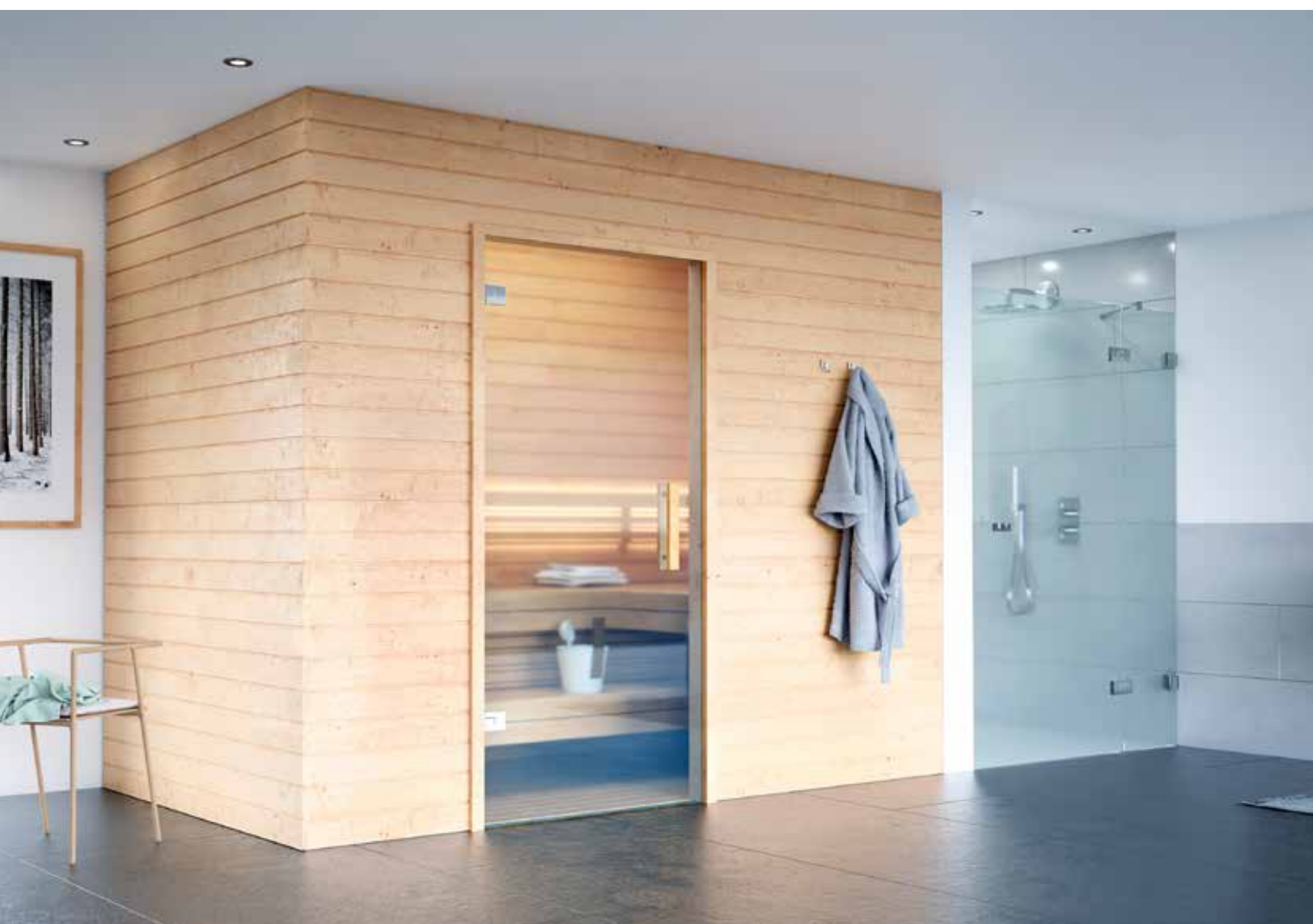



glass/wall 90° one side Wall Mounted

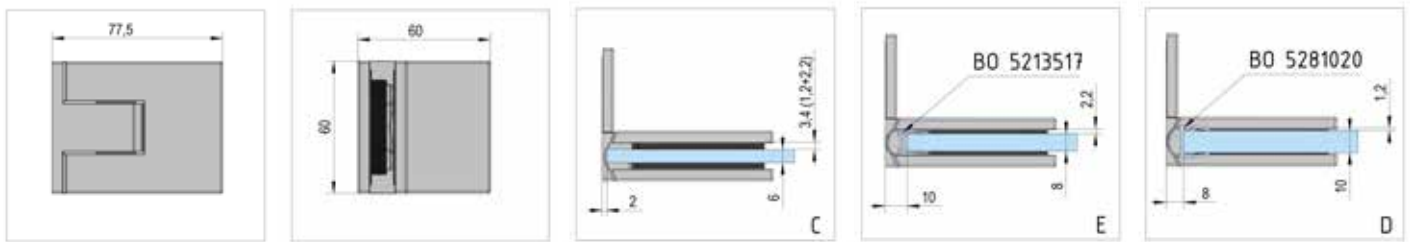

FINISH	ART. NO.	SALES UNIT
shiny chrome-plated	BO 5410310	1 pair
stainless steel look	BO 5410311	1 pair
black	BO 5410312	1 pair
SAUNA		
shiny chrome-plated	BO 5410310S	1 pair
stainless	BO 5410311S	1 pair
black	BO 5410312S	1 pair

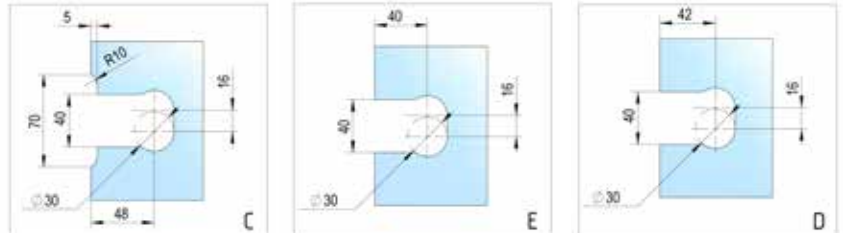

- Glass thickness 6, 8, 10 mm
- Load capacity 50 kg per pair (Sauna 32 kg per pair)
- Self-closing from 20°
- Continuously adjustable zero position

- with chamfer
- with 6 mm glass thickness: maximum door dimension: 1000 x 2250 mm
- with 8 mm glass thickness: maximum door dimension: 1000 x 2250 mm
- with 10 mm glass thickness: maximum door dimension: 855 x 2250 mm / 1000 x 2000 mm

glass/glass 90° Glass Mounting

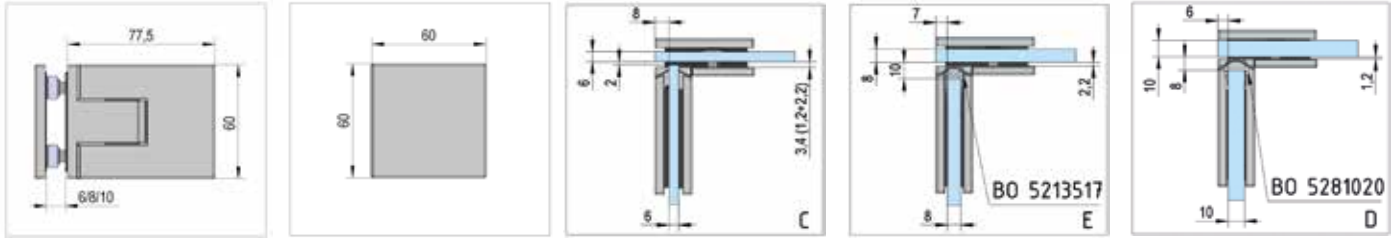

FINISH	ART. NO.	SALES UNIT
shiny chrome-plated	BO 5410340	1 pair
stainless steel look	BO 5410341	1 pair
black	BO 5410342	1 pair

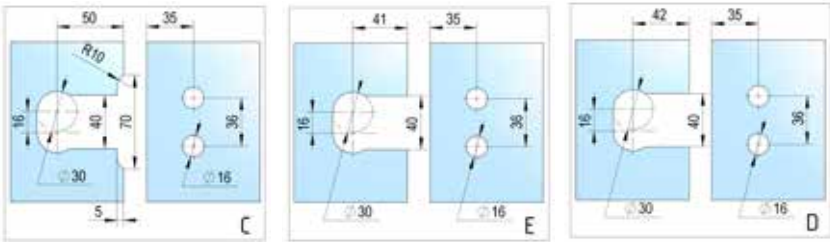

- Glass thickness 6, 8, 10 mm
- Load capacity 50 kg per pair
- Self-closing from 20°
- Continuously adjustable zero position
- with 6 mm glass thickness: maximum door dimension: 1000 x 2250 mm
- with 8 mm glass thickness: maximum door dimension: 1000 x 2250 mm
- with 10 mm glass thickness: maximum door dimension: 855 x 2250 mm / 1000 x 2000 mm

Corner Clamp glass/wall 90°

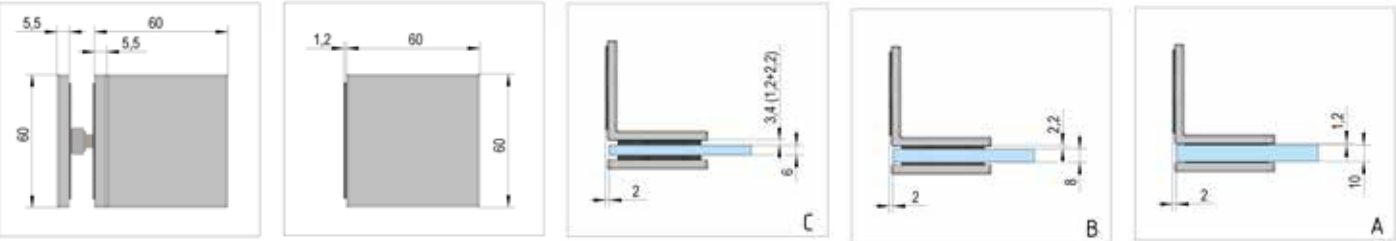

FINISH	ART. NO.	SALES UNIT
shiny chrome-plated	BO 5410330	1 pair
stainless steel look	BO 5410331	1 pair
black	BO 5410332	1 pair

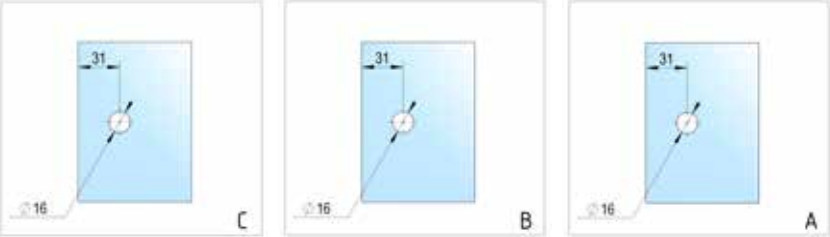

- Glass thickness 6, 8, 10 mm



glass/glass 180° Glass Mounting

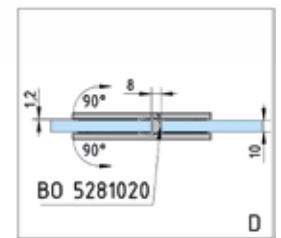
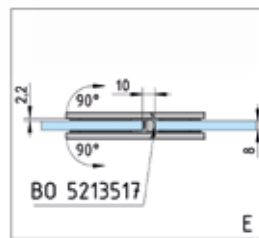
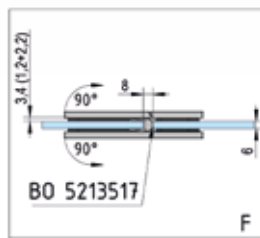
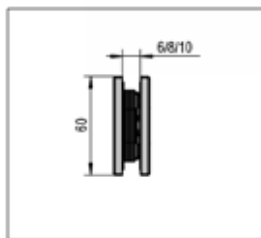
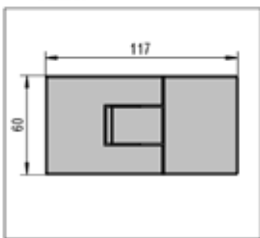

FINISH	ART. NO.	SALES UNIT
shiny chrome-plated	BO 5410300	1 pair
stainless steel look	BO 5410301	1 pair
black	BO 5410302	1 pair
SAUNA shiny chrome-plated	BO 5410300S	1 pair
SAUNA stainless	BO 5410301S	1 pair
SAUNA black	BO 5410302S	1 pair

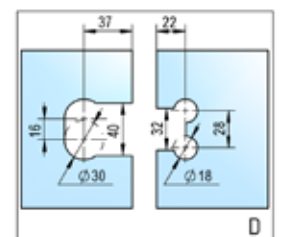
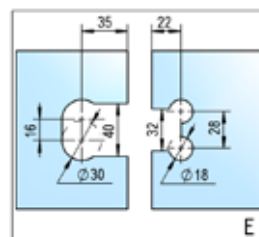
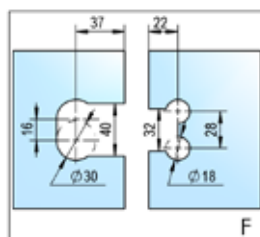

- Glass thickness 6, 8, 10 mm
- Load capacity 50 kg per pair (Sauna 32 kg per pair)
- Self-closing from 20°
- Continuously adjustable zero position

- with 6 mm glass thickness: maximum door dimension: 1000 x 2250 mm
- with 8 mm glass thickness: maximum door dimension: 1000 x 2250 mm
- with 10 mm glass thickness: maximum door dimension: 855 x 2250 mm / 1000 x 2000 mm

Corner Clamp glass/glass 90°

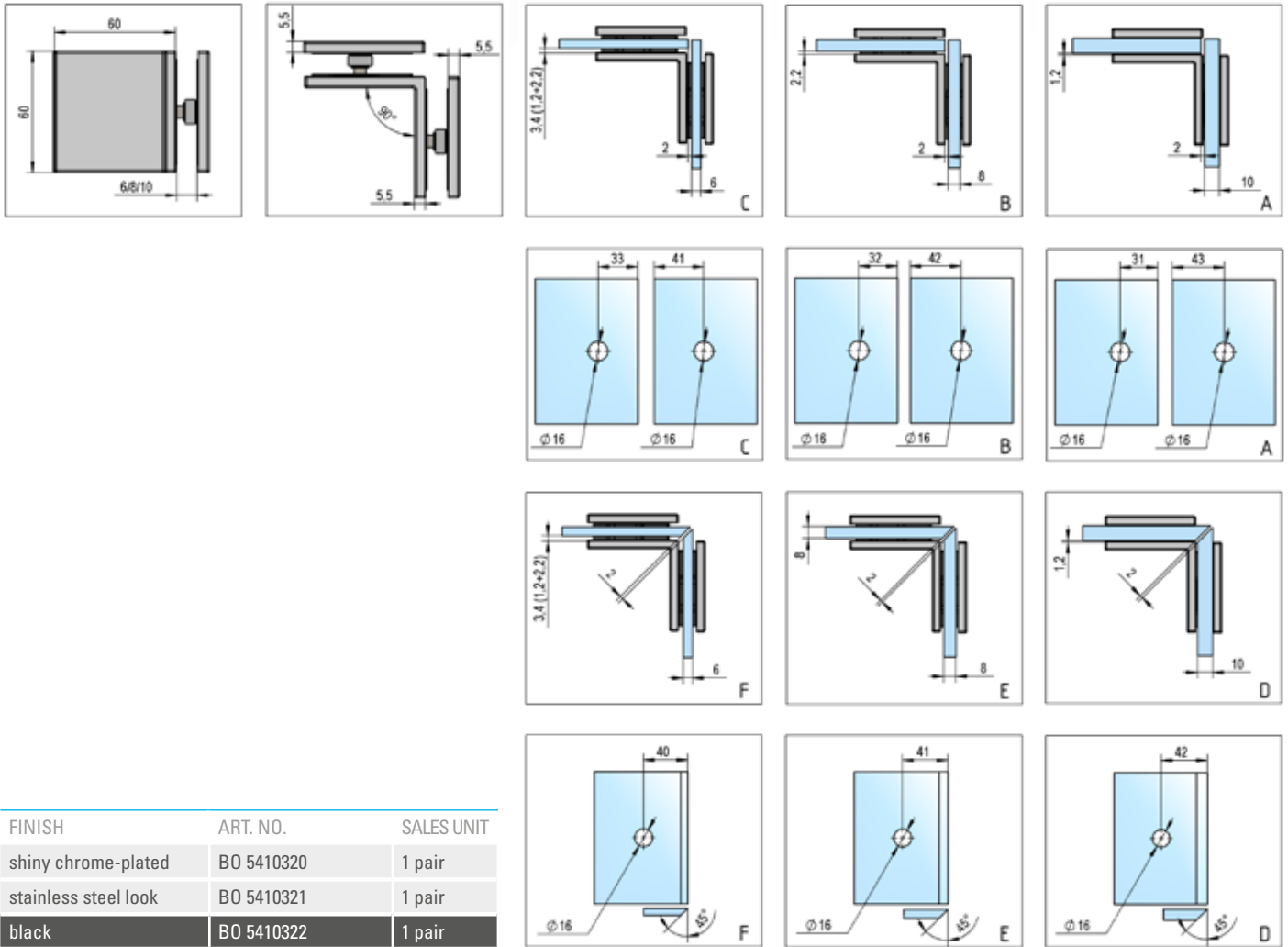

• Glass thickness 6, 8, 10 mm



glass/glass 135° Glass Mounting

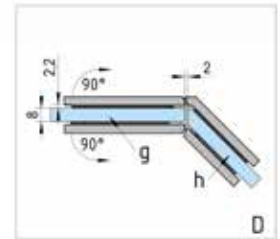
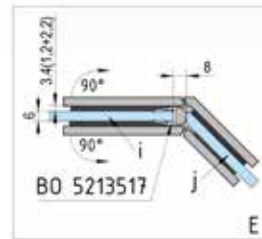
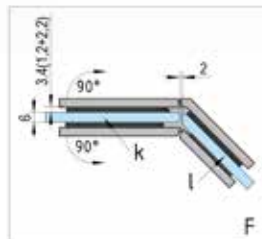
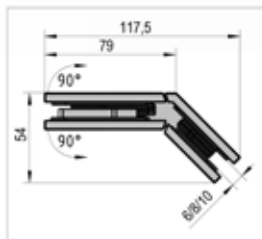
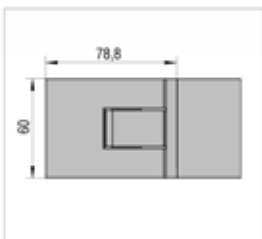

FINISH	ART. NO.	SALES UNIT
shiny chrome-plated	BO 5410344	1 pair
stainless steel look	BO 5410345	1 pair
black	BO 5410346	1 pair

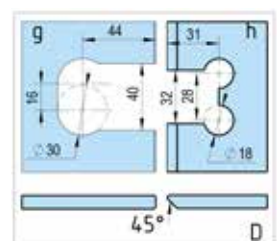
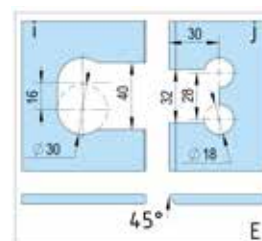
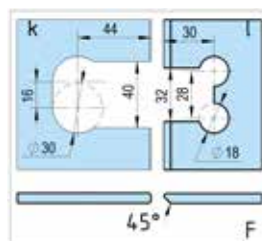

- Glass thickness 6, 8, 10 mm
- Load capacity 50 kg per pair
- Self-closing from 20°
- Continuously adjustable zero position

- with 6 mm glass thickness: maximum door dimension: 1000 x 2250 mm
- with 8 mm glass thickness: maximum door dimension: 1000 x 2250 mm
- with 10 mm glass thickness: maximum door dimension: 855 x 2250 mm / 1000 x 2000 mm

Corner Clamp glass/glass 135°

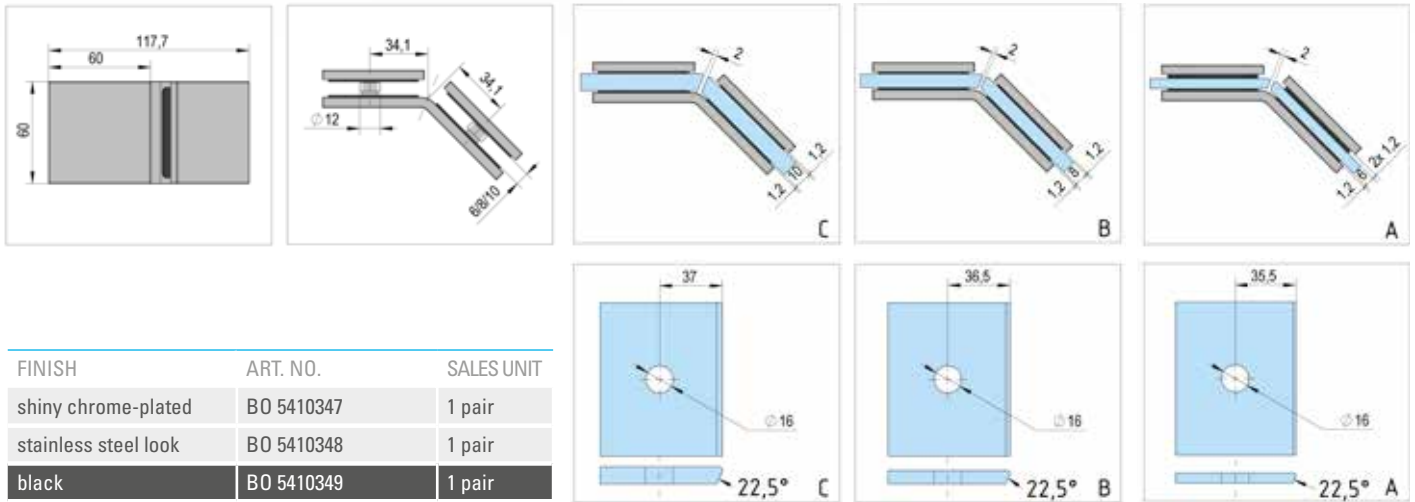

• Glass thickness 6, 8, 10 mm



Juna is the first shower door hinge series developed and manufactured in-house by Bohle. All products are subjects to strict quality controls. We have therefore applied a voluntary manufacturer's warranty of five years for the Juna shower door hinge series. For warranty terms, see www.bohle.com.

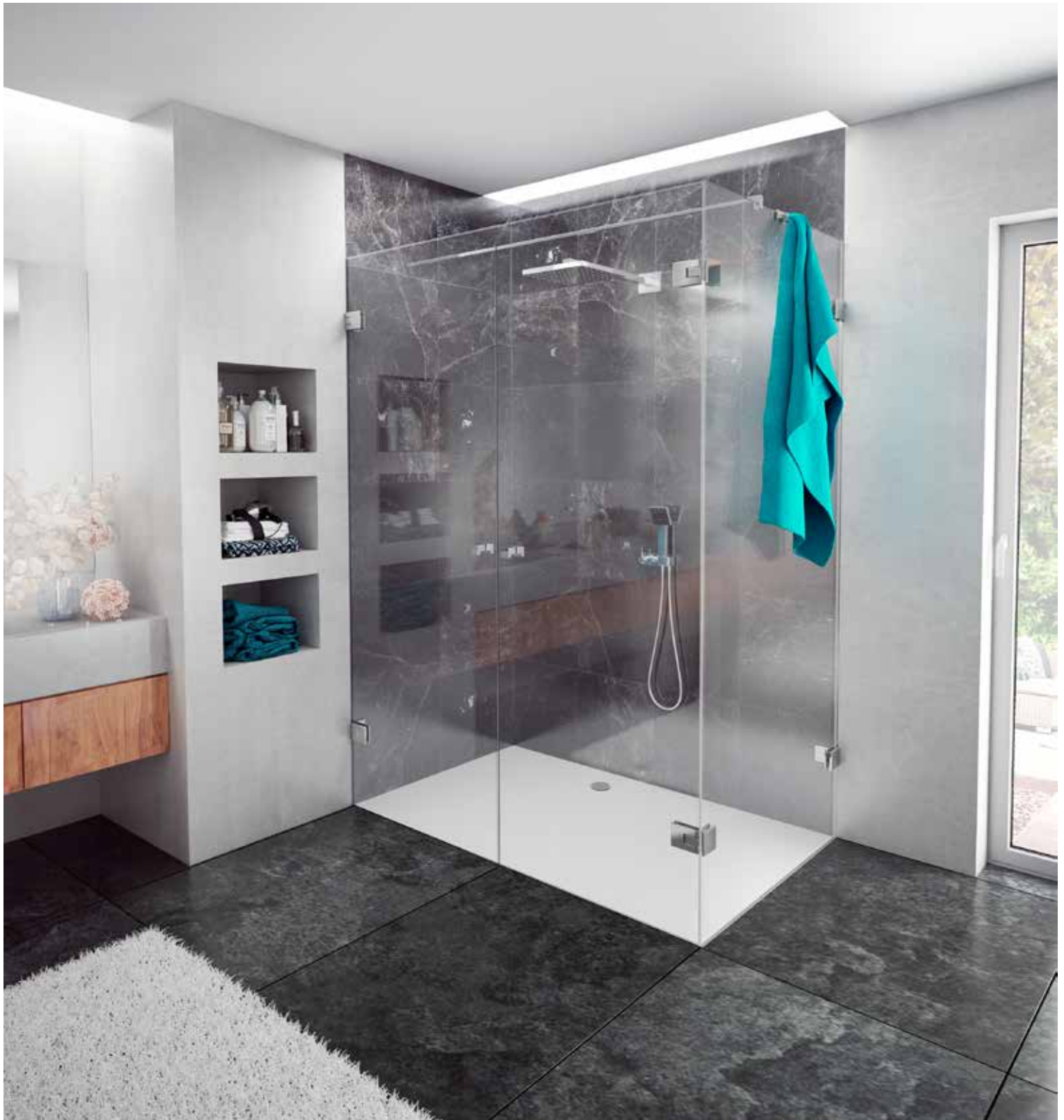

 Bohle

Bohle Ltd. Fifth Avenue
Tameside Park
Dukinfield
Cheshire · SK16 4PP

T 0800 616151 (freephone)
T +44 161 3421100
F +44 161 3440111

info@bohle.ltd.uk
www.bohle.com

