

Technical Notebook MAPETHERM - EXTERNAL THERMAL INSULATION COMPOSITE SYSTEM FOR BUILDINGS

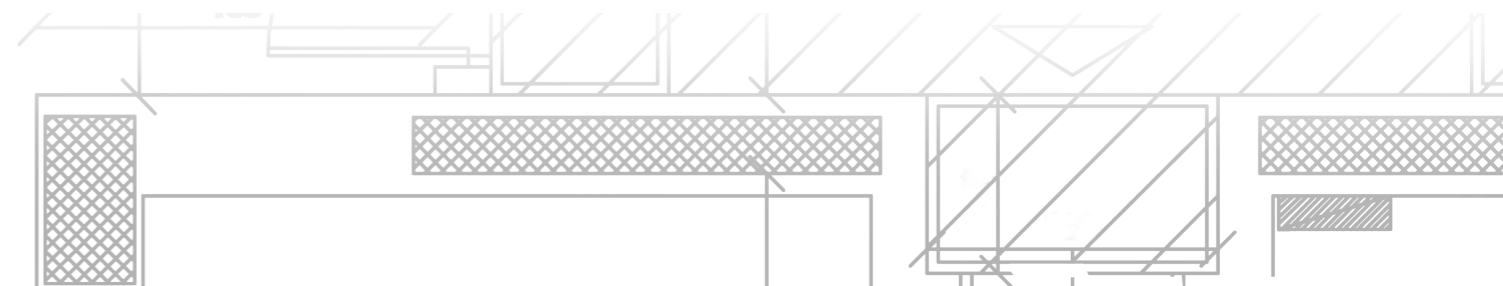

Technical Notebook **MAPETHERM - EXTERNAL THERMAL INSULATION COMPOSITE SYSTEM FOR BUILDINGS**

MAPEI UK LTD
Mapei House, Steel Park Road
Halesowen, West Midlands. B62 8HD
Tel. 0121 508 6970
Fax. 0121 508 6960
Website: www.mapei.co.uk
E-mail: info@mapei.co.uk



www.mapei.co.uk

ADHESIVES - SEALANTS - CHEMICAL PRODUCTS FOR BUILDING

MAPETHERM - EXTERNAL THERMAL INSULATION COMPOSITE SYSTEM FOR BUILDINGS

Mapei UK Limited are EST (Energy Saving Trust) approved and are also full members of INCA & NIA. In addition to this, Mapei UK Limited meets all the requirements that are stated within ECO for warranties as we are approved by SWIGA & Canal Group. Mapei UK Limited also complies fully with PAS 2030 regulations.

For further information please contact Mapei UK Limited.

Mapei UK Limited can offer warranties for the Mapetherm System that satisfy the requirements that are stated within ECO warranties. Mapei UK Limited is approved by SWIGA & Canal Group.

For further information please contact Mapei UK Limited.

page 02	1. THERMAL INSULATION
page 03	1.1 TYPES OF THERMAL INSULATION
page 04	1.2 THERMAL INSULATION AND DESIGN
page 06	2. MATERIALS
page 06	2.1 SYSTEM BUILD-UP
page 09	3. MAPEI SYSTEMS
page 11	3.1 INSULATING PANELS
page 14	4. MAPEI RESEARCH
page 15	4.1 MAPETHERM SYSTEM
page 16	5. MAPETHERM SYSTEM
page 18	5.1 PREPARATION OF SUBSTRATES BEFORE BONDING THE PANELS
page 18	5.2 BUILDINGS IN STONE OR BRICK MASONRY
page 20	5.3 BUILDINGS IN REINFORCED CONCRETE OR RENDERED MASONRY
page 20	5.4 CONCRETE WALLS AND/OR CRACKED STRUCTURES
page 21	5.5 CONCRETE STRUCTURES AND/OR ELEMENTS
page 22	5.6 INSTALLING INSULATING PANELS
page 23	5.7 BASECOAT, LEVELLING AND FINISHING
page 25	6. CONSTRUCTION DETAILS
page 31	7. ETA / BBA CERTIFICATION
page 31	7.1 MAPETHERM XPS SYSTEM
page 32	7.2 MAPETHERM EPS SYSTEM
page 32	7.3 MAPETHERM EPS PLUS SYSTEM
page 35	7.4 MAPETHERM M. WOOL SYSTEM
page 37	8. SPECIFICATIONS
page 37	8.1 ADHESIVES AND BASECOAT AND LEVELLING COMPOUNDS
page 38	8.2 INSULATING PANELS
page 39	8.3 BASE PRIMERS FOR SURFACE PREPARATION
page 43	8.4 FINISHING PRODUCTS

MAPETHERM - EXTERNAL THERMAL INSULATION COMPOSITE SYSTEM FOR BUILDINGS

1. Thermal insulation

The energy performance of a building, which was not considered particularly significant in the past, is becoming more and more important due to environmental restraints and the increasing cost of energy. This trend has increased the need to limit heat losses from homes, which in turn has led to the creation of a new, fast-growing sector in the modern building industry which is dedicated to the development of suitable solutions. The aim of an efficient insulating system for buildings is to guarantee that not only the air, but also walls, floors and ceilings all reach the correct temperature. A cold sensation derives from both a low environmental temperature and a low temperature of the walls, ceilings and floors.

This is due to the effect of radiation: for example, when you are close to an open fire you can feel the heat given off, while the part of the body not exposed to the fire is colder. The opposite occurs when you are close to a window. The average temperature between that of the air and that of the walls is the "operating temperature", that is, the temperature perceived by a human body. To have a feeling of comfort the walls of the home must also be well heated, but to avoid them cooling down, they must be insulated with a "warm blanket" of insulation.

A positive effect of thermal insulation is that it prevents problems and defects caused by the presence of condensation (such as the formation of mould and dark stains). These problems may appear if the internal surface of walls are too cold, even if only in certain areas. Therefore, to avoid such problems, the insulation must be installed on the external walls - with this solution, the entire shell of the building is kept at a uniform temperature without the formation of temperature gradients between separate zones.

Thermal insulation leads to a reduction in both heating costs and the emission of green house gasses - if buildings are correctly insulated, they use less energy and this again is positive for the environment.

The need to reduce emissions into the atmosphere has pushed those governments which signed the Kyoto Protocol in 1997 to issue laws regarding energy efficiency (The European Directive EC 2002/91).

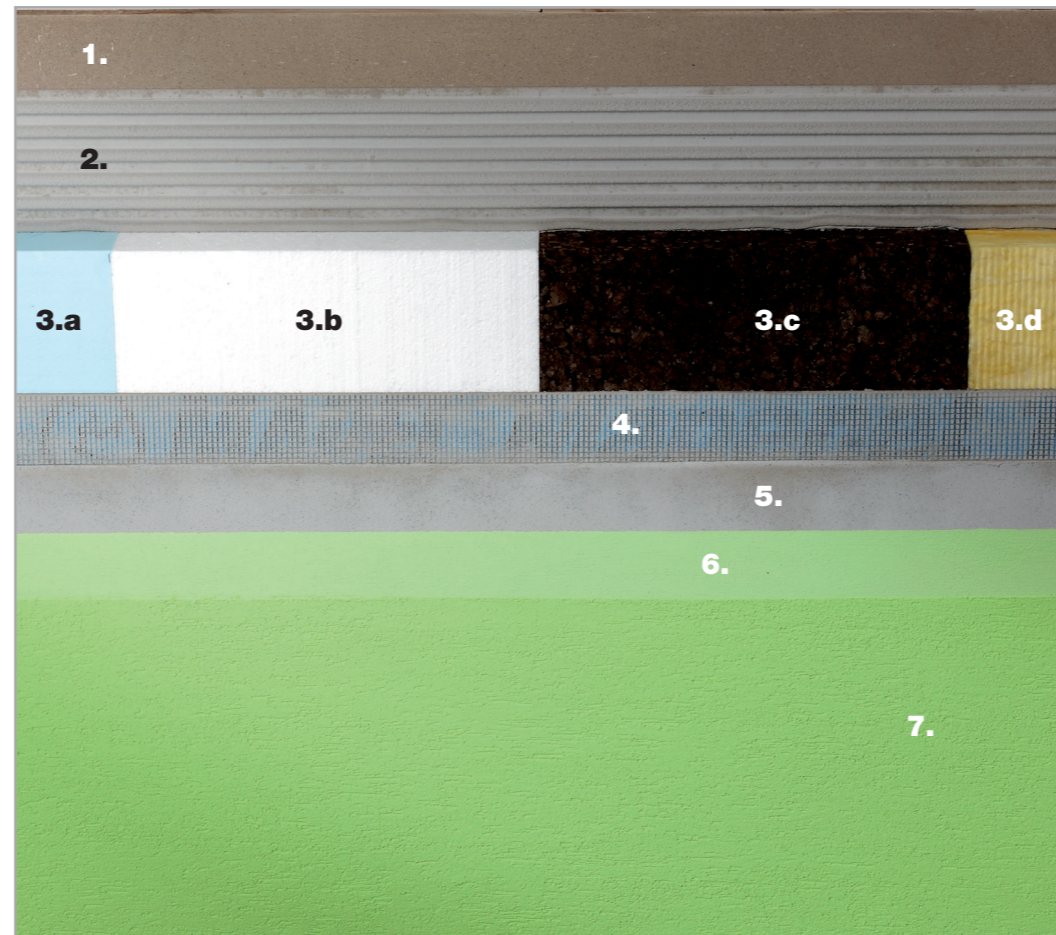

1. Substrate
2. MAPETHERM AR1 GG Adhesive
3. Insulation
 - a. MAPETHERM XPS
 - b. MAPETHERM EPS
 - c. MAPETHERM CORK
 - d. MAPETHERM MINERAL FIBRE
4. MAPENET
5. MAPETHERM AR1 GG Adhesive
6. Topcoat Primer
7. Topcoat

1.1 TYPES OF THERMAL INSULATION

A - Insulating walls from the inside of rooms

This type of insulation does not alter the external appearance of a building. It costs less because scaffolding is not required for installation operations and is certainly the best option for buildings which are not used continuously: for example, a holiday cottage which is only used at the weekend. This solution creates a building which heats up quickly when the heating is switched on because only the air and not the walls is heated up. However, the building will cool down just as quickly as, the heating system must be switched on all the time to keep the rooms warm because of the low thermal inertia, and also the walls will always remain cold. The main drawback with this type of insulation is that it does not eliminate thermal bridges. Moreover a careful condensation risk analysis must be carried out to avoid aggravating the problem of condensation in the walls. The rooms must be completely emptied to install this type of insulation. Beside this, if a layer is added on the internal surface of rooms, the volume and living space will be reduced and the position of electrical fittings and radiators must be modified accordingly.

B - Insulation in wall cavities

This is installed in the cavity between thick external walls and smaller sectioned internal walls by inserting rigid panels of insulating material, although loose granules are also used in certain cases. Insulating material positioned in cavities increases the thermal inertia of a building compared with the previous solution, but offers similar results to the technique of installing insulation on internal walls, that is, thermal bridges and their related problems are not eliminated.

C - External Insulation

By insulating the external walls of a building (thermal insulation), all thermal bridges are eliminated and the thermal storage capacity of buildings is increased. The walls warm up, accumulate heat and then return it back into

MAPETHERM - EXTERNAL THERMAL INSULATION COMPOSITE SYSTEM FOR BUILDINGS

the rooms. This means that the heating system needs to be switched on for less hours which means lower fuel consumption and a lower emission level of pollutants.

One main advantage of thermal insulation is that thermal bridges are completely eliminated, those critical points (such as around window and door fittings, edges, pillars in the masonry, etc.) where the formation of mould is more likely to occur. Also, thermal insulation may be installed without creating too much disturbance to those who live or work in the building and the rooms do not need to be emptied (work is carried out externally by installing the insulation material on the outside of the building only). It is an ideal solution when renovation work is carried out on façades because creating thermal balance of a structure also avoids physical stresses and impedes the formation of new cracks.

1.2 THERMAL INSULATION AND DESIGN

When designing a building an analysis of the context in which it will be built should also be carried out. As with provision for garden areas, parking spaces and other services, the building's exposure to the sun and the local micro-climate in which it will be located should also be taken into consideration. The best types of insulating and finishing products to be installed should be carefully assessed to avoid the formation of condensation and micro-biological deterioration, even on a short term basis, which would otherwise cause an unhealthy living environment (please refer to the Biological Deterioration section).

Any insulation system must be correctly dimensioned in order to work efficiently. New buildings must be constructed according to the latest building regulations and standards in compliance with geographic circumstances. Similarly, thermal upgrading of an old building should not be carried out without the assistance of a specialist who, with the use of special software, will calculate the correct dimensions of the thermal insulation system according to the customer's specific requirements (what type of products, budget, etc.) Mapei offer a free building physics report.



RENOVATION



BESPOKE

A thermal insulation system is the most practical solution for an immediate improvement in the energy regime of an old building and CO₂ emissions into the atmosphere are reduced straight away. In new buildings, thermal bridges around pillars and floor slabs are completely eliminated, the thickness of the walls may be reduced and, therefore, the living space will be larger and more comfortable. The system is quite complex, in that it is composed of various materials and accessories (adhesives, smoothing compounds, insulating panels, anchors, reinforcement mesh, primers, render and various accessories), and each component must be correctly designed and manufactured to suitable quality standards to form a reliable, long-lasting system.

Low Consumption

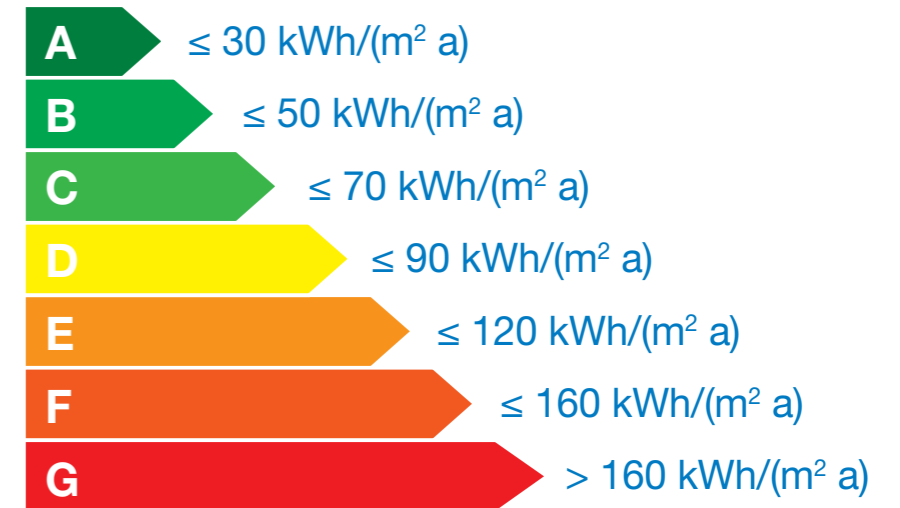

High Consumption

MAPETHERM - EXTERNAL THERMAL INSULATION COMPOSITE SYSTEM FOR BUILDINGS

The European Community has given a mandate to EOTA (the European Organization for Technical Approval) to establish guidelines to verify the technical aspects of insulation systems, which has led to ETAG 004 (the European Technical Approval Guideline) being issued, which contains the reference norms for testing the materials which make up the various systems available. It is important to point out that the design of the system and the expertise of the installation company play a decisive role on the performance of the system, because all too often important installation details which influence the service life of the system are overlooked.

2. MATERIALS

2.1 SYSTEM BUILD-UP

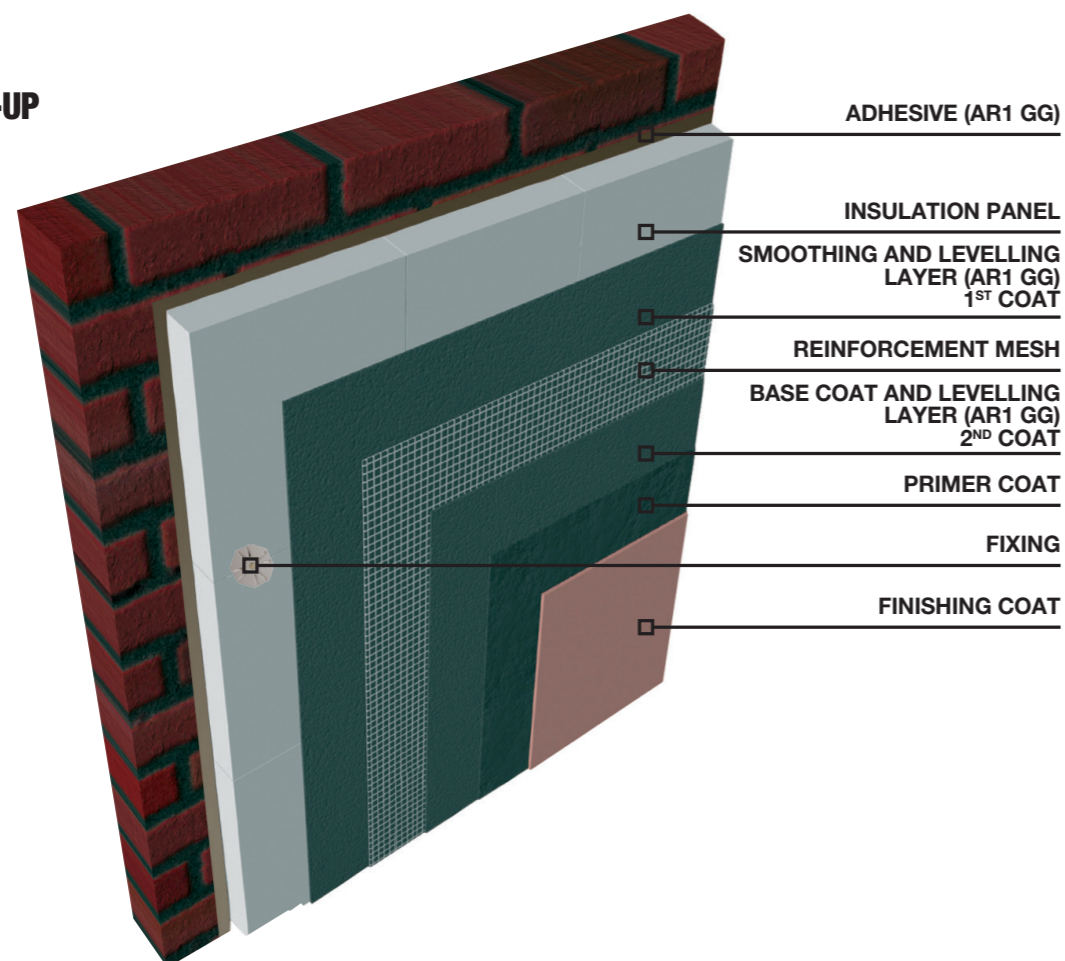

MAPETHERM - EXTERNAL THERMAL INSULATION COMPOSITE SYSTEM FOR BUILDINGS

Characteristics and performance expected from each component:

Adhesive/Basecoat and levelling compound:

The adhesive must guarantee the performance of the adhesion over the years and be resistant to shear and peeling phenomena. If the manufacturer uses a certified quality production cycle and, above all, if the adhesive is used correctly on site with the recommended mixing ratios and correct application techniques and methods.

Insulating panel:

The technician who chooses the most suitable dimensions of the system is also responsible for choosing the most suitable type and thickness of insulating panel. These are calculated by considering the type of building (new or old), the construction of the walls, the load-bearing system (concrete, bricks, block, stone, etc.), the area where the building is located and current norms and regulations. There are many types of panels available on the market and they are available in different sizes and materials. It is impossible to say which is the best and they must be selected according to each project's specific requirements. There is no single type of panel available on the market at the moment which offers all the performance characteristics required, so for each project the most important characteristics must be identified to help choose a panel which most closely meets these requirements. Panels with the CE-mark must be used and which have been declared as suitable for the intended use by the manufacturer.

Reinforcement mesh:

Reinforcing mesh is used to help reduce the potential risk of cracking caused by stresses acting on the façade due to thermal transitions and the resulting temperature difference between the two sides of the panel.

It must be treated with an anti-alkali primer to protect it against the basic pH levels of the base coat in which it is embedded. Reinforcement mesh

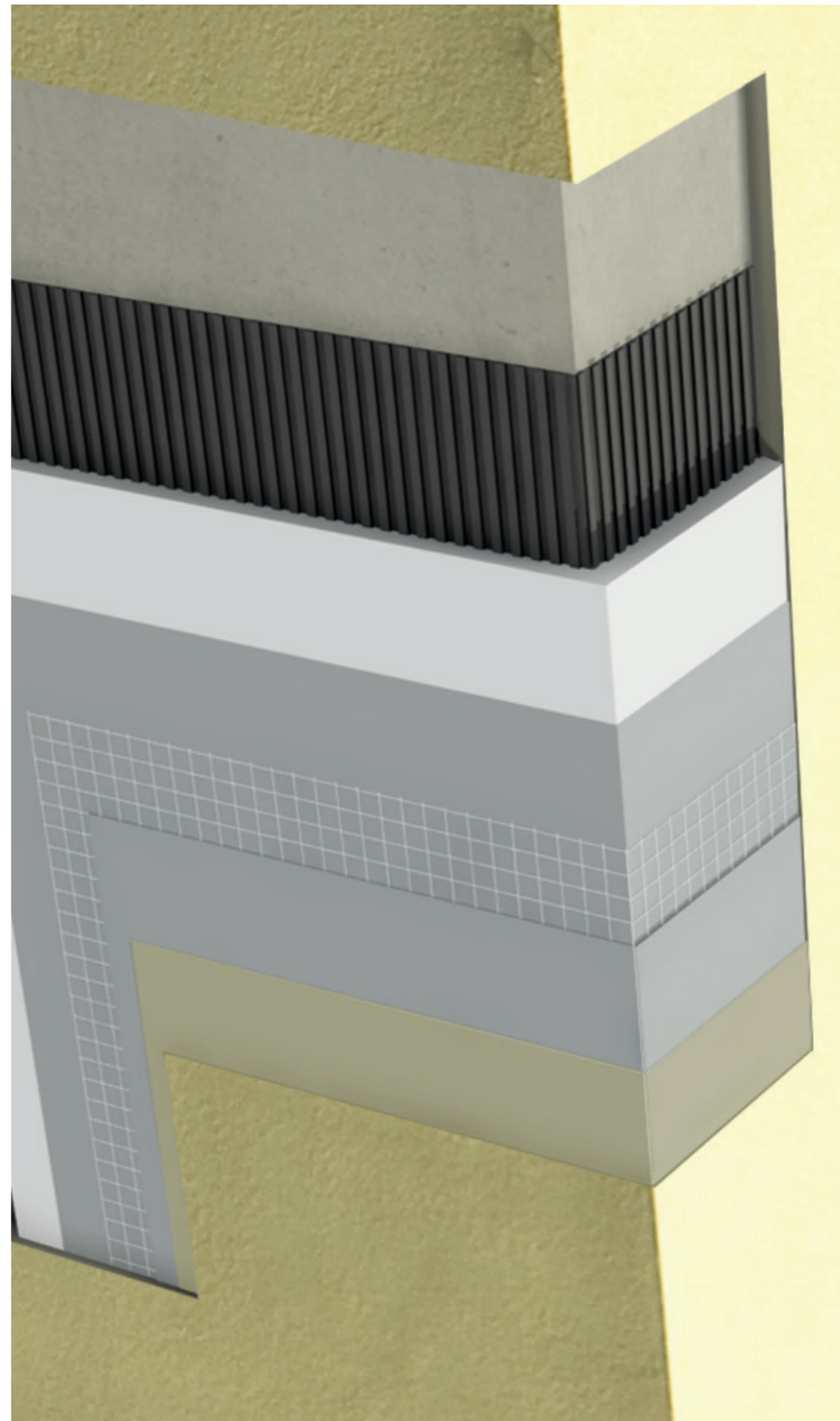

improves resistance to impact loads on the system. Heavy-grade mesh (300 g/m²) is even stronger which is why, in certain cases, it is used on areas that are deemed to have a higher risk of impact.

Fixings:

The number of fixings depend on the type of wall and bonding technique used. There are many types of fixings available on the market but, as with the reinforcement mesh, their cost is often the only parameter taken into consideration and more important factors, such as the type of insulating material, the length of the plug and the type of wall, are often overlooked. Some European countries have started classifying plugs and a letter (such as A, B, C, D or E) are stamped on the head of the plug to indicate for which type of substrate they are most suitable. (A for concrete - B for full bricks - C for perforated bricks - D for lightweight porous concrete - E for cellular concrete).

Primer:

The use of primer is indispensable in that it prepares and evens out surfaces to be covered with the final coating, and avoids uneven colours caused by the different reactions between materials and/or different absorption levels. If a coloured primer is used, especially for brighter colours, the finish is more even and its hiding power capacity is improved.

Render:

Insulation systems must be protected against weather influences with a high quality render and not just simple paint. There are a number of types available on the market, and are classified according to the type of binder used (mineral or organic) and whether they contain one of the various types of resin: silicon, acrylic, vinyl, etc. A light colour is highly recommended to protect the system against high temperatures caused by direct sunlight, which could then trigger off stresses and strains in the system.

MAPETHERM - EXTERNAL THERMAL INSULATION COMPOSITE SYSTEM FOR BUILDINGS

3. MAPEI SYSTEMS

MAPETHERM XPS



The **MAPETHERM XPS** system uses an extruded polystyrene insulating panel. It has a rough surface to improve the bond of the adhesive and is characterised by its low water absorption, good compressive strength and excellent insulating properties.

Thermal conductivity λ : 0.032 - 0.036 W/mK

Water vapour diffusion resistance μ :80-100

It has received the European Technical Approval ETA 04/0061 issued by the ITC Institute in San Giuliano Milanese (Milan, Italy) (see Certification section).

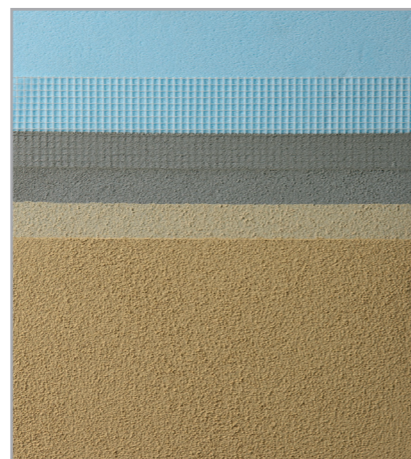

MAPETHERM XPS



MAPETHERM M.WOOL

MAPETHERM EPS



The **MAPETHERM EPS** system uses an expanded polystyrene insulating panel. This type of panel has a very competitive price, is easy to apply and has excellent insulating properties.

Thermal conductivity λ : 0.034 - 0.040 W/mK

Water vapour diffusion resistance μ :30-70

It has received the European Technical Approval ETA 10/0025 issued by the OIB Institut in Vienna (see Certification section).

BBA 13/4977



MAPETHERM EPS



MAPETHERM CORK

MAPETHERM M.WOOL



The **MAPETHERM M.WOOL** system uses an insulating panel in mineral wool treated with a water-repellent, hygro-hardening primer. It is characterised by its excellent fire-resistance, extremely high permeability to vapour and excellent soundproofing properties.

Thermal conductivity λ : 0.032 - 0.048 W/mK

Water vapour diffusion resistance μ : 1.1-1.4

It has received the European Technical Approval ETA 10/0024 issued by the OIB Institut in Vienna (see Certification section).

BBA 13/4977

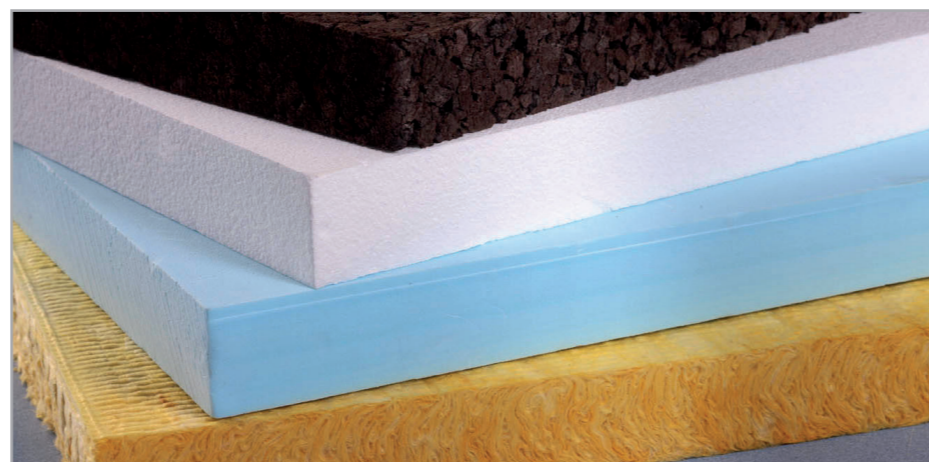

MAPETHERM CORK

The **MAPETHERM CORK** system uses a brown expanded natural cork panel with no chemical binders. It is characterized by its excellent permeability to vapour and excellent stability against ageing. It is made from recyclable, eco-sustainable material.

Thermal conductivity λ : 0.040 - 0.048 W/mK

Water vapour diffusion resistance μ :5-30

MAPETHERM PHS

High thermal performance rigid thermoset insulation board.

Thermal conductivity λ : 0.020 - 0.023 W/mK

Tested to ETAG 004

3.1 INSULATING PANELS

Which is the best panel?

Continuous research by manufacturers into insulating materials means that the market offers panels with increasingly improved thermal conductivity, but the real advantages in terms of thickness of the insulator are obtained when the difference is around 10 mW (milliwatt). Thermal conductivity is often considered to be the only important value to assess the performance of a panel, without considering the fact that a variation in the density of the material with which it is made offers different performance levels. All too often, the same type of panel is used out of pure habit or because of its price, thus generalising site conditions. The best way of deciding which is the most suitable panel is to clearly define its objectives and check the various performance levels on offer:

- Thermal insulation
- Soundproofing
- Reaction to fire
- Strength
- Stability
- Water absorption

MAPETHERM - EXTERNAL THERMAL INSULATION COMPOSITE SYSTEM FOR BUILDINGS

- Permeability to water vapour
- Natural composition
- Cost

The insulating properties of the wall and architectural features must also be taken into consideration.

Thermal insulation

It is important to remember that the best insulator is stationary, dry air (at 300 K, 100 kPa) which with a lambda value (λ) equal to 0.026 W/m²K (see UNI 7357) can be improved only by special panels (such as silica aero gel under vacuum at a pressure of 1.7×10^{-5} atmospheres) and certain heavy gases. It is important that this concept is clear because, in order to achieve higher values, air must be entrapped, held stationary and dry in the form of bubbles as small and waterproof as possible and the amount of material used, which is the source of heat conduction, must be reduced as much as possible.

Soundproofing

There is no doubt that a building which is also well soundproofed is more comfortable. Good soundproofing performance is offered by mineral wool panels (glass and mineral). Panels are produced by weaving the fibers formed by melting the mineral raw materials and the fibrous consistency of the final product is an excellent dampener of sound-waves.

Reaction to fire

Every type of material has its own reaction to fire which is defined on the basis of tests carried out according to the EN 13501-01 which establishes a specific classification system which goes from A (non-flammable product) to F (unclassified product). The reference parameters take into consideration especially the *combustibility level*, *fire propagation velocity* and the *development of heat per unit of time*. Flammable materials



San Giorgio Infants School - Cesena - Italy



(vegetable and synthetic insulators) are made fire-proof by applying special paint on the surface or by adding fire-proof substances to the material during production.

Mechanical strength

The strength of almost all insulating panels is reduced due to the low density or fibrous consistency of the panel itself. Sometimes, however, higher performance levels are required which are difficult to obtain because of the intrinsic nature of the materials from which they are made. The most common example are skirting-boards at the base of walls which are subject to accidental impact by pedestrians or vehicles (motorcycles and bicycles). Manufacturers often refer to *compressive strength 10% of compressing*, which basically indicates temporary compression, while in rare cases they declare *compressive strength 2% of compressing*, which indicates the maximum, permanent deformation which a panel may support.

Stability

Thermal stability means the dimensional stability regarding variations in the dimensions of the panel due to poor curing before being put on sale and the change in temperature and variation in the level of humidity to which it is exposed. *Chemical-physical stability* regards the possibility of inter-actions or reaction of the insulating material with solvents or UV or the remote possibility of a reduction in the volume of insulation material in cavity walls. A particular problem typical of certain materials is *thermal-physical stability*, that is, their capacity to maintain the same level of conductivity over the years.

Water absorption

A condition which must be avoided at all costs is a material's behaviour to entrap and hold water. Any material which can have a variable humidity content has the potential to drastically reduce its insulating capacity and trigger off premature deterioration. Materials sensitive to such phenomenon

MAPETHERM - EXTERNAL THERMAL INSULATION COMPOSITE SYSTEM FOR BUILDINGS

include all fibrous, mineral, synthetic and synthetic products. Some types of materials considered to be almost non-absorbent (1-1.5%) are certainly better than others but not completely immune to this phenomenon, because the absorption percentage is expressed according to volume and corresponds to 10-15 litres per m³.

Permeability to vapour

The correct definition is *water vapour diffusion resistance* (μ), which is the capacity of a material to offer the least resistance possible to the passage of vapour. A more important indication is the value S_d which considers the resistance to vapour with reference to the thickness of the material. A good general rule is to place the material with the lowest water vapour diffusion resistance towards the external part of the wall structure to avoid the formation of condensation in wall cavities. A correct level of vapour permeability allows the hygrometric balance of the wall structure to be maintained (after heavy rainfall, for example) but is unable to release the damp produced inside the rooms by normal residential activities. It is important to remember that a family of 4 produces more than 10 litres of water vapour during their normal daily routine which must be released by ventilation. Unlike certain information available, the amount of vapour which migrates through a wall structure is around 1-3% (approximately 0.1-0.3 g/h/m²) of the amount eliminated by simply ventilating the rooms.

Natural composition

The demand for natural materials for manufacturing insulating panels is mainly met by using materials such as cork, wood, Kenaf and other vegetable and animal fibres, but also minerals such as calcium silicate hydrate or recycled cellular glass.

Cost

The cost of insulating materials is obviously taken into consideration, especially because in certain cases the cost of the panel represents more



Multi-discipline Centre - Toscanelle di Dozza - Italy



than 50% of the overall cost of a thermal insulation system. The most economical material available is expanded polystyrene (EPS) which is used in 90% of insulation systems. Natural and mineral materials are much more expensive and cost up to 4 or 5 times more, but can offer more complete performance levels.

4. MAPEI RESEARCH

4.1 MAPETHERM SYSTEM

MAPEI entered the thermal insulation sector after carrying out an in-depth analysis of what happens to a thermal insulation system which is exposed to the typical forces which act on a façade, taking into consideration that the system is composed of completely different materials which must act together in synergy to offer their best performance.

The considerations made after the analysis led to the conclusion that an insulation system is very complex and that the adhesive is the key component. Its capacity of resisting to shear stresses and peel stresses are entirely absorbed by the adhesive. What generates these stresses?

The weight of the system and depression induced by wind normally generate low stresses, which is easy to verify by applying a simple force balance analysis. By far the highest stresses are generated by the contrast in deformations induced by the high temperature differences between the two faces of the insulating panel. The following images offer a graphic illustration of the key role of the adhesive.

With reference to graphs 1, 2 and the following graphs, which highlight what happens to a façade in winter and then in summer, the calculations indicate that, during winter when the outside temperature is -5°C and the room temperature is 20°C, the difference in temperature between the two faces of the panel is more than 18°C. These conditions generate forces equivalent to almost 800 μ shrinkage deformation and more than 3 mm

MAPETHERM - EXTERNAL THERMAL INSULATION COMPOSITE SYSTEM FOR BUILDINGS

flexural deformation which must be entirely overcome by the adhesive.

Similar considerations may be made by considering the conditions in summer where even higher values are found, as illustrated in graph 4. Only high quality adhesives, designed and manufactured for similar conditions, are able to guarantee sufficient performance levels. From an analysis of the stresses, the following rule for correct application may also be established: only a continuous layer of adhesive applied by carefully considering the flatness avoids serious problems such as those illustrated in graphs 2 and 4. The widespread use of applying adhesive in beads and/or points does not necessarily correspond to the peeling stresses generated on the entire layer of adhesive. This application method causes a high level of stress where the adhesive is present, and it is inevitable that the surface bonding limits are exceeded and the panel becomes detached, as shown in graph 4. Flatness of the substrate is important because large deviations create the ideal condition for high eccentricity when bending moments are induced, which increases the stress on the adhesive which may exceed the surface bonding limit at the adhesive-panel interface. For this reason, in applications where a continuous layer of adhesive is not used, which is happening more and more often on site, adhesives with much better performance characteristics are required to install efficient, long-lasting thermal insulation systems, such as MAPEI **MAPETHERM AR1 GG** mono-component adhesives, which have been used for some time.

MAPEI, which has always been a reference point in the adhesives sector thanks to their constant commitment to the research and development of new, innovative systems, has created **MAPETHERM SYSTEM** which guarantees a reduction in energy consumption in both winter and summer, increases living comfort by perfectly balancing the room temperature and the temperature of the walls, eliminates condensation of water vapour in cavity walls and, above all, offers a further important advantage: the MAPEI guarantee based on their undisputed leadership in the adhesives sector.

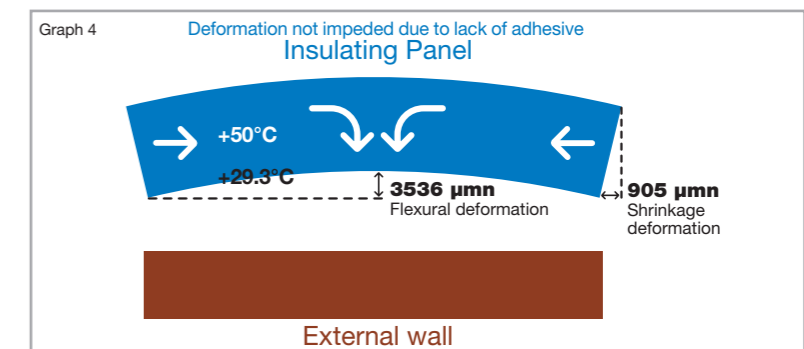
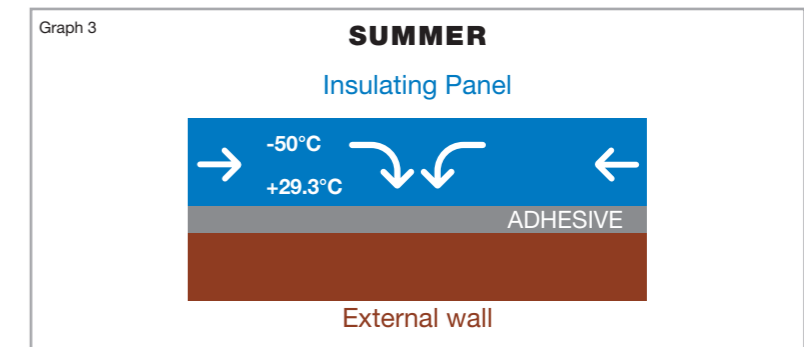
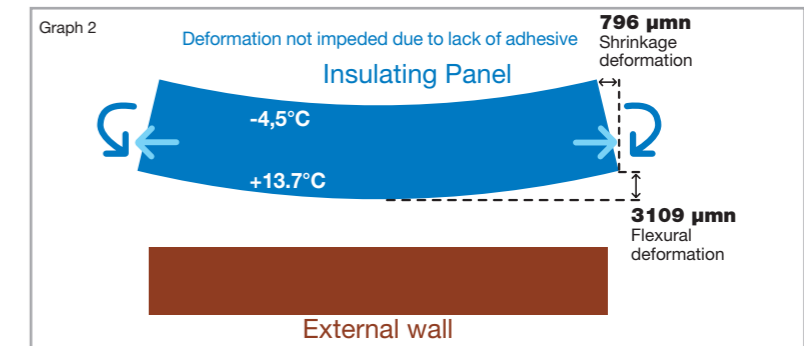
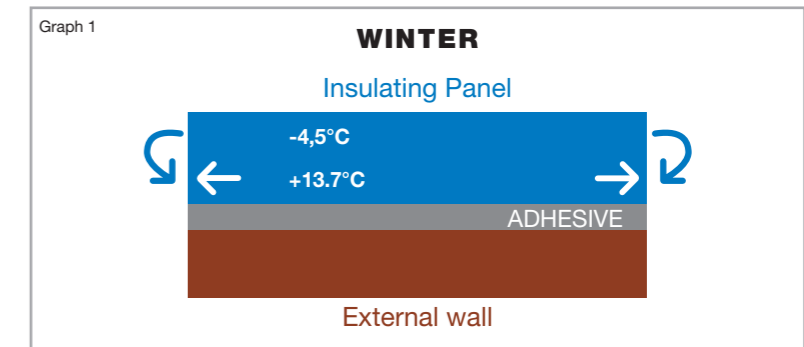

MAPETHERM - EXTERNAL THERMAL INSULATION COMPOSITE SYSTEM FOR BUILDINGS

5. MAPETHERM SYSTEM

A correct, functional insulation system must include a careful selection of not only the insulating layer, but all of the materials used to prepare the substrate, bond the insulating panels, smooth and level the surface and finish the façade according to the final appearance required. Similarly, correct design and installation on site of construction details in more problematic areas of the building are also essential to guarantee living comfort and obtain the reduction in energy consumption expected.

The following paragraphs contain a full description of how to use the materials and how to install a complete **MAPETHERM SYSTEM**.

5.1 PREPARATION OF SUBSTRATES BEFORE BONDING THE PANELS

Surfaces on which an insulation system is to be installed must be mechanically strong, free of any areas at risk of detachment, perfectly clean and free from all traces of dust, dirt, grease, stripping compound and any other substance which may compromise the adhesive fixing of the panels to the substrate.

5.2 BUILDINGS IN STONE OR BRICK MASONRY

On buildings with a natural brick or stone finish (not rendered), the consistency of the stone blocks and the condition of the surface of the bricks must be checked and all flaky or loose parts must be eliminated. In the case of porous stone blocks with a powdery or dusty surface, a primer such as **MALECH**, a micronized acrylic resin-based product in water dispersion used to prepare the surface of general masonry, may be used, applying it on the surface of the masonry with a brush or by spray. If the joints between the stone or bricks have been worn away by rainwater, they will need to be pointed using mortar with suitable elastic-mechanical properties (such as **MAPE-ANTIQUE MC** pre-blended, de-humidifying



Wall with rising damp



The areas of loose render must be removed before bonding the insulating panel

mortar used for renovating damp stone, brick and tuff masonry or **POROMAP INTONACO** pre-blended, de-humidifying, salt-resistant, grey insulating mortar, which is applied by hand or with a rendering machine and is used for renovating stone, brick and strong masonry. If the wall is particularly out of plumb or uneven due to the type of construction materials used (such as rough-cut or rounded stone blocks) the surface will have to be leveled off and/or made vertical by rendering the surface with mortar with a low modulus of elasticity, high tensile and flexural strength and bond extremely well to the substrate (such as **NIVOPLAN** smoothing mortar for walls + **PLANICRETE** synthetic latex rubber for cementitious mortar, used to improve the bond and strength of the mortar).

In the case of walls with rising damp a thermal insulation system **MUST NEVER BE APPLIED**. If such a system is applied, the damp in the wall would increase due to a lower evaporation rate from the walls after bonding the insulating panels.

During winter, because of the effect of the heating system in the building, the increased level of damp would cause a critical situation and provoke the formation of surface efflorescence and blistering of the paintwork inside the building. In summer, on the other hand, the migration of salts towards the external face of the wall followed by their crystallization, together with an increase in vapour tension, could cause parts of the adhesive to become detached and compromise the thermal insulation.

Therefore, if there is rising damp in the walls, a thermal insulation system may only be installed after protecting the walls with a mechanical barrier (by inserting waterproof sheets into slits cut in correspondence with construction joints in the wall using a diamond-tipped saw) or with chemical products (such as the injection of waterproofing or water-repellent products into the wall such as **MAPESTOP**, an agent injected into the wall composed of concentrated silicon micro-emulsion which forms a chemical barrier against rising damp present in masonry).

If it is not possible to use any of the systems mentioned above (because the building is in a seismic area for example or because of the nature of the

MAPETHERM - EXTERNAL THERMAL INSULATION COMPOSITE SYSTEM FOR BUILDINGS

walls), one alternative is to clean up the outside wall using macro-porous de-humidifying render (such as **MAPE-ANTIQUÉ** or **POROMAP**) up to the level of the first floor slab and apply the insulation system from that level up. Rooms on the ground floor, on the other hand, may be insulated from the inside.

5.3 BUILDINGS IN REINFORCED CONCRETE OR RENDERED MASONRY

In the case of old buildings in either masonry or reinforced concrete walls which are already rendered, before bonding the insulating panels, the render must be checked to make sure it is well attached to the substrate. Any loose portions must be removed.

Areas where the render has been removed may then be repaired using cementitious mortar with added latex (such as **NIVOPLAN + PLANICRETE**). On painted render (or render with a surface coating such as plastic), make sure these types of coatings are well bonded to the substrate. After removing any areas which are either loose or flaky, brush down well and wash the entire surface with high-pressure water equipment.

Similarly, with façades with ceramic or glass mosaic coatings or coated with clinker tiles, make sure they are well bonded to the substrate. Areas which are detached must be removed and repaired with **NIVOPLAN + PLANICRETE**.

5.4 CONCRETE WALLS AND/OR CRACKED STRUCTURES

In the case of cracked walls, the first step is to investigate the cause of the cracks to check if they are stable or due to movements in the building which are still active. In the latter case, before installing an insulation system, work will have to be carried out on the building to impede any further movements and, therefore, stop the cracks propagating into the



Remove & replace with NIVOPLAN+PLANICRETE



Position the support profiles: make sure they are horizontal using a spirit level



Fasten the support profiles in place using expansion plugs

panels, smoothing layer and finishing coat of the insulation.

If the cracks are stable, on the other hand, and their movement is only influenced by the inevitable thermo-hygrometric gradients, the facing walls of buildings in stone or brick may be rebuilt using the tacking technique. If there is only slight cracking, on the other hand, they may be repaired by grouting them with the same adhesive used to bond the panels **MAPETHERM AR1 GG** mono-component, large-grained cementitious adhesive and smoothing compound for thermal insulating systems).

The same technique may be used to grout cracks in render caused by hygrometric shrinkage and/or a high absorption of water by the substrate when the render was applied. Grouting with mortar may also be used to seal localized cracks in buildings with a reinforced concrete framework, in buffer wall-beam joints and buffer wall-pillar joints. In new buildings where the insulating system is installed as soon as construction has been completed, there is a risk that cracking at the reinforced concrete framework/buffer-wall interface forms after installing the cladding system and provokes cracks and localized detachment in the smoothing and finishing layers. To reduce this risk to a minimum, when applying the render, embed a strip of mesh to hold the render and protect these areas.

5.5 CONCRETE STRUCTURES AND/OR ELEMENTS

On new concrete walls, high-pressure water (120 atm) must be used to clean them down, and special additives may also be included to remove all traces of stripping compound from the surface.

On old concrete structures, clean the surface thoroughly to remove all loose parts, surface laitance and all traces of dust, oil, grease and dirt.

If the concrete is deteriorated and there are areas with corroded reinforcement rods and delaminated and/or detached concrete, repair these areas as follows:

MAPETHERM - EXTERNAL THERMAL INSULATION COMPOSITE SYSTEM FOR BUILDINGS

- remove the deteriorated concrete;
- clean the reinforcement rods with a stiff brush, by sand-blasting or hydro-blasting;
- protect the rods by applying a cementitious passivating mortar (such as **MAPEFER 1K** mono-component, anti-corrosion cementitious mortar for reinforcement rods);
- rebuild the area using compensated-shrinkage mortar (such as **MAPEGROUT T40** medium-strength, fibre-reinforced thixotropic mortar for repairing concrete, **MAPEGROUT BM** two-component thixotropic mortar with a low modulus of elasticity or **PLANITOP 400** anti-shrinkage, quick-setting, thixotropic cementitious mortar used for repairing the cortex and for finishing reinforced concrete). After rebuilding the area, wait until the substrate is fully cured before applying the thermal insulating system.

5.6 INSTALLING INSULATING PANELS

Before installing the insulating panels, support profiles must be fixed in place using expansion plugs.

The insulating panels are bonded to the substrate using a special adhesive **MAPETHERM AR1 GG** mixed with water.

If the substrate is flat, spread an even layer of adhesive over the whole of the back face of the insulating panel. If the surface is not flat, apply a series of spots and beads so that at least or more than 40% of the surface is covered with adhesive. When applying the panels, make sure the adhesive does not run into the joints between the adjacent panels: the adhesive is more conductive and would form a thermal bridge.

The thickness of the coat of adhesive should be sufficient to cover the surface of the panel evenly and/or eliminate differences in flatness in the substrate up to 4 mm. To obtain the thickness required, we suggest using a No. 10 notched trowel. Apply the panels starting from the bottom

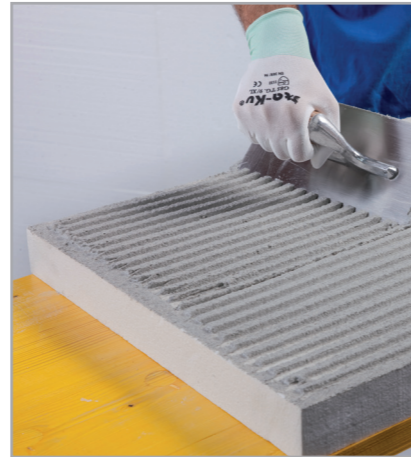

Spread an even layer of adhesive on the back of the insulating panel



Press down the panel with a float

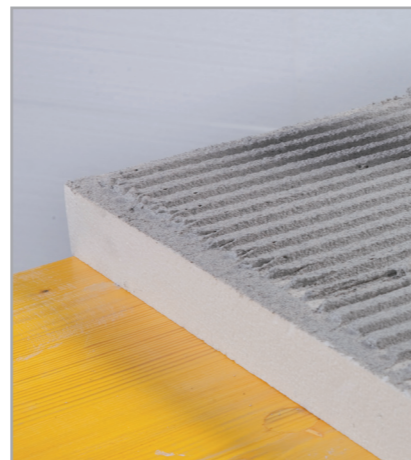

Close-up of the edge of the panel



Drill holes for the plugs

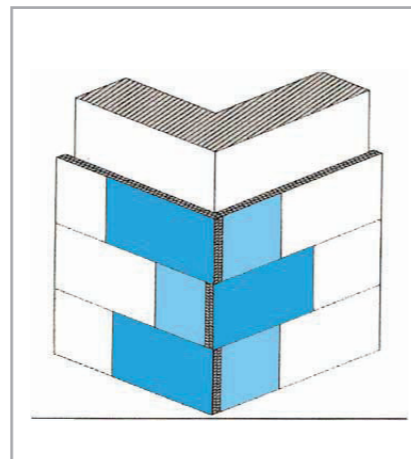

Typical corner section insulation boards



Insert the plugs

of the wall working upwards, with the longest side of the panels placed horizontally, and also stagger the vertical joints in correspondence with the corners and edges. To get the maximum bond from the adhesive, apply the panel immediately after spreading the adhesive on the back of the insulating panel, especially in hot and/or windy weather.

In order to form the maximum contact area between the substrate, adhesive and panel, use a float to press down on the panel immediately after installation and then check the flatness using a straight edge. After installing the panels, if the vertical joints between the panels are wider than 2 mm, fill the gaps with insulating material. Apart from the adhesive (but not instead of the adhesive), the panels may be fixed in place mechanically using polypropylene plugs in correspondence with the hardened adhesive. As a general rule, use two plugs for each panel if the substrate shows excellent cohesion, is perfectly flat and adhesive has been applied over the entire surface of the back of the panel.

If, however, the substrate shows poor cohesion and/or is not flat, or if the adhesive has been applied in beads and spots, use up to 6 to 8 plugs per square metre and insert them in correspondence with the top of the panels until the more cohesive part of the substrate has been reached.

Immediately after installing the panels, put strengthening elements (**MAPETHERM PROFIL MESH**) corner beads to the edges. These elements must not be fastened in place with plugs or nails, but bonded to the insulating panel by pressing them against the edge so the excess adhesive flows through the holes in the profiles.

5.7 SMOOTHING, LEVELLING AND FINISHING

The basecoat mortar must only be applied once the adhesive is hard enough (the time required depends on the weather conditions and normally takes at least 24 hours). Apply an even layer of basecoat mortar minimum 4mm. While



MAPETHERM - EXTERNAL THERMAL INSULATION COMPOSITE SYSTEM FOR BUILDINGS

it is still fresh, place **MAPETHERM NET** alkali-resistant glass fibre mesh on the surface overlapping the edges by at least 10 cm. To form an even layer which covers and embeds the mesh, just spread it out evenly over the surface. Avoid forming bubbles or folds. If they do form, they must not be removed by cutting the mesh. In correspondence with the edges (of buildings, openings, etc.) the reinforcement net must overlap that of the edge guard. In correspondence with openings for doors, windows, etc. additional reinforcement must be inserted by placing pieces of mesh diagonally to the openings to avoid the formation of cracks in correspondence with the edges, where the stresses in the system are normally concentrated.

When the basecoat layer is perfectly dry (after at least 2-3 days in good weather) apply a coat of primer to even out the absorption of the substrate. Wait at least 12 hours before applying the finishing coat. Apply the topcoat by using a stainless steel trowel then finish off the surface with a sponge or plastic float, according to the type of product used. The finishing cycle must take into consideration the type of insulating panel, architectural details of the building, the context in which it has been built, the local climate and the instructions given by the designer and site manager. Please note that the colour of the finishing coat must have a light reflection index of at least 20%. This precaution must be taken because the façades of buildings are exposed to sunlight which generates temperatures which reach more than 50°C during the Summer. The use of dark colours must be avoided to avoid worsening this condition.

To avoid any part of the insulating panel coming into contact with the outside so that water, air or dust cannot enter the joints between the insulation system and other parts or elements in the building, apply metallic protective profiles using **MAPEFOAM** extruded polyethylene foam cord and **MAPEFLEX AC4** one-component acrylic sealant in water dispersion, according to the following construction details.

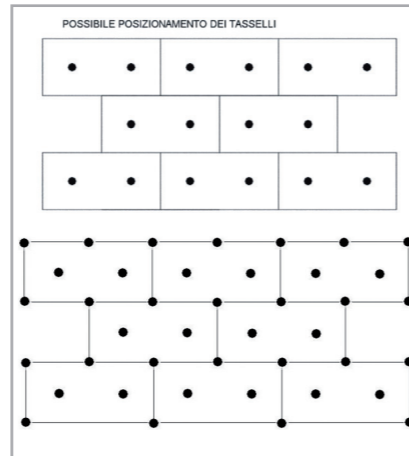

Positioning of the plugs



Overlap the edges of the net by at least 10 cm



Apply the first coat of the smoothing and levelling layer



Apply the finishing layer of render



MAPETHERM NET



Finish off the surface of the render with a sponge float

6. CONSTRUCTION DETAILS

If there are particulars or features on the wall, the system must be installed as illustrated in the sketches on the following pages.

As a general rule, the following guidelines must always be followed:

- the insulating layer must be continuous with no interruptions to avoid the formation of thermal bridges;
- whenever the insulation has to be interrupted because of the presence of openings or protruding objects (window-sills, windows, etc.) it must be correctly sealed to avoid water infiltrating under the insulating layer.

Position of particulars and features

Detailed drawings of various construction particulars and features are shown on the following pages.

**MAPETHERM - EXTERNAL
THERMAL INSULATION COMPOSITE
SYSTEM FOR BUILDINGS**

BASE RAIL FOR MASONRY

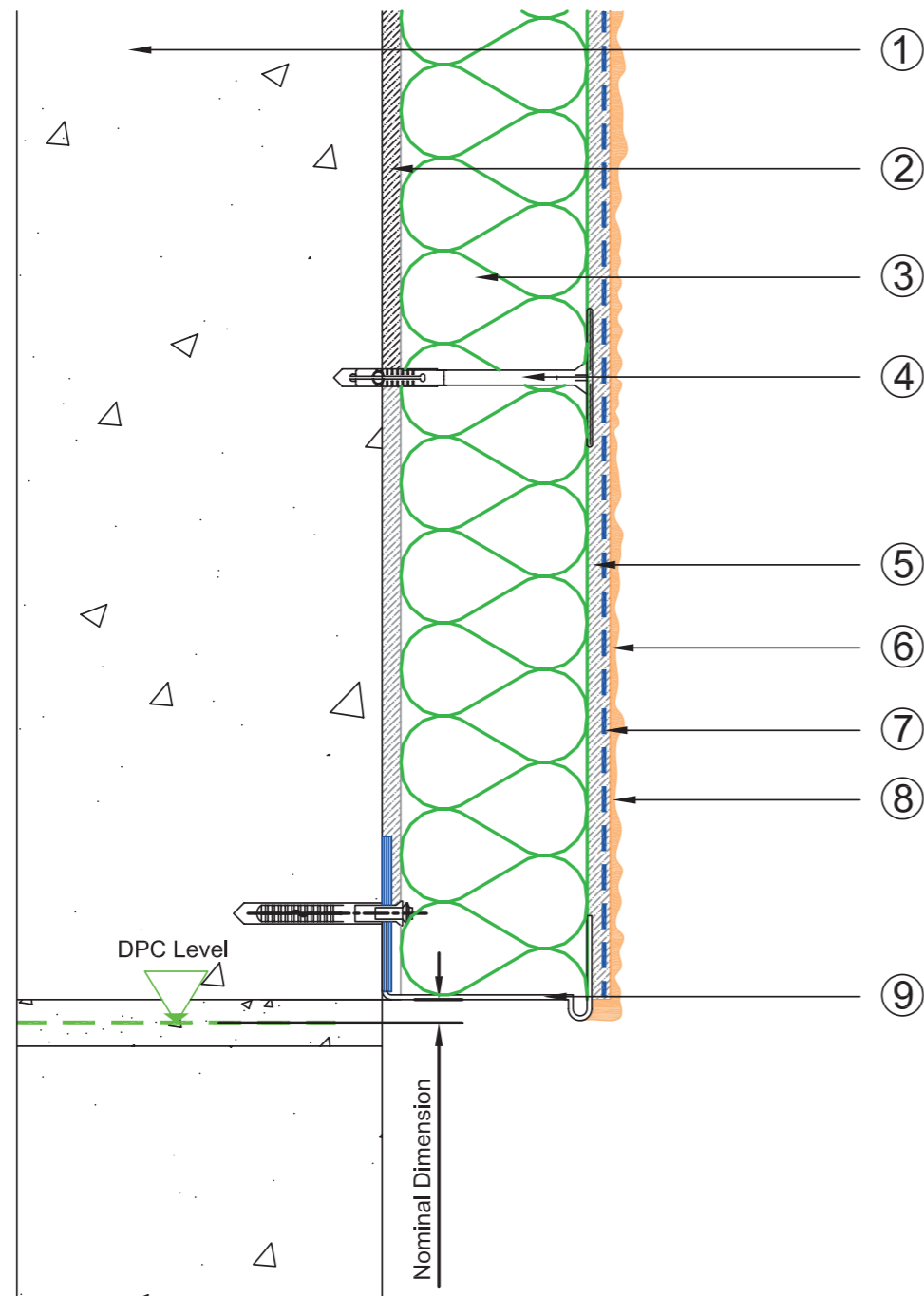

1. Masonry Substrate
2. MAPETHERM AR1 GG - Cementitious adhesive coat min 5-10mm
3. MAPETHERM EPS - Available in thickness 40mm-300mm
4. Mechanical fixings - ETA approved min embedment 40mm
5. MAPETHERM AR1 GG - Cementitious base coat applied min 4mm
6. MAPETHERM PRIMER - Coloured silicate /siloxane or acrylic primer

7. MAPETHERM NET - Alkali resistant glass fibre mesh embedded into reinforcing coat
8. SILANCOLOR TONACHINO or QUARZOLITE TONACHINO Top Coat Finish
9. Base Rail

CILL DETAIL FOR MASONRY

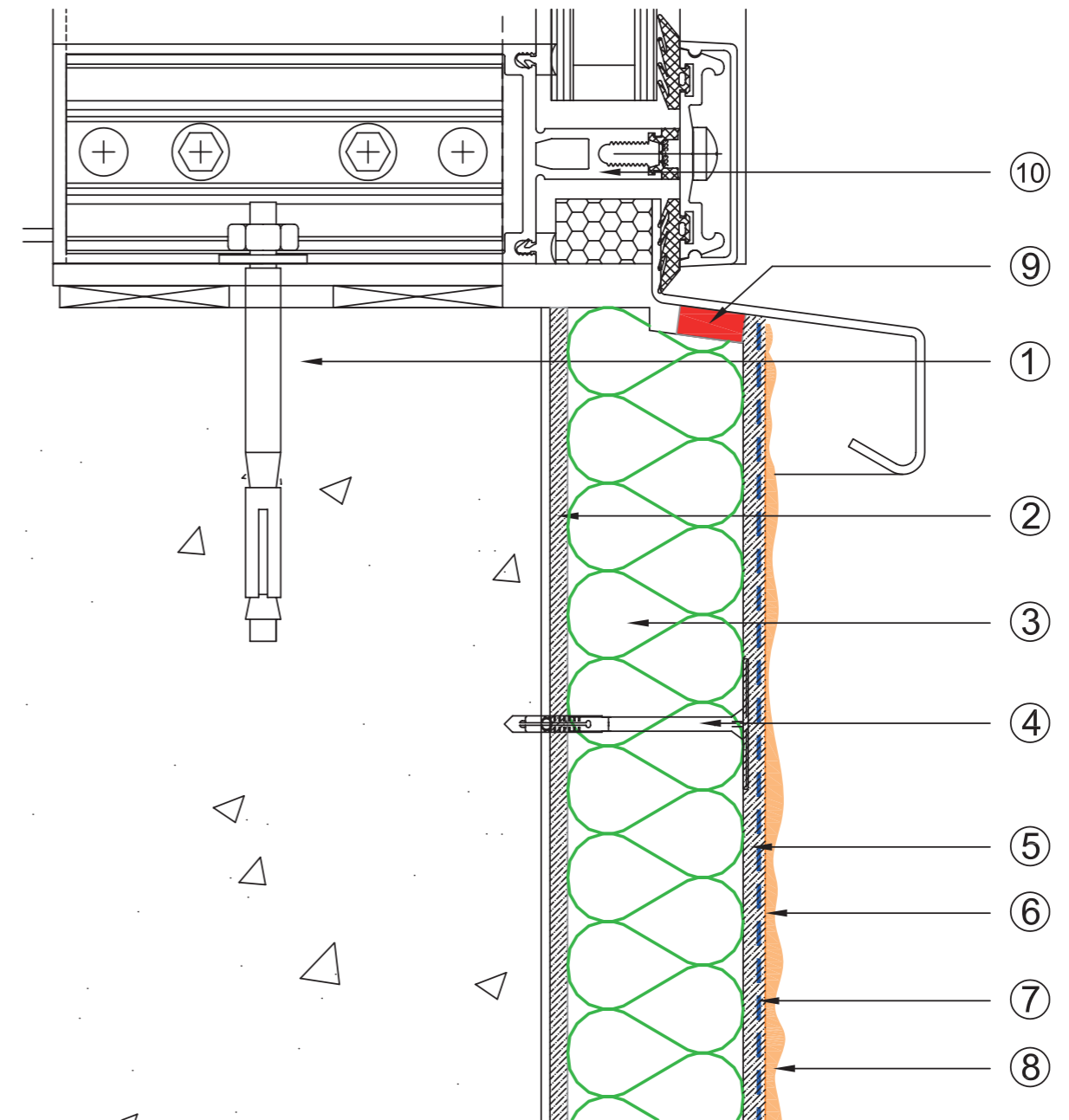

1. Masonry Substrate
2. MAPETHERM AR1 GG - Cementitious adhesive coat min 5-10mm
3. MAPETHERM EPS - Available in thickness 40mm-300mm
4. Mechanical fixings - ETA approved min embedment 40mm
5. MAPETHERM AR1 GG - Cementitious base coat applied min 4mm
6. MAPETHERM PRIMER - Coloured silicate /siloxane or acrylic primer

7. MAPETHERM NET - Alkali resistant glass fibre mesh embedded into reinforcing coat
8. SILANCOLOR TONACHINO or QUARZOLITE TONACHINO Top Coat Finish
9. Sealing Strip
10. Typical Window Frame

**MAPETHERM - EXTERNAL
THERMAL INSULATION COMPOSITE
SYSTEM FOR BUILDINGS**

ROOF DETAIL FOR MASONRY

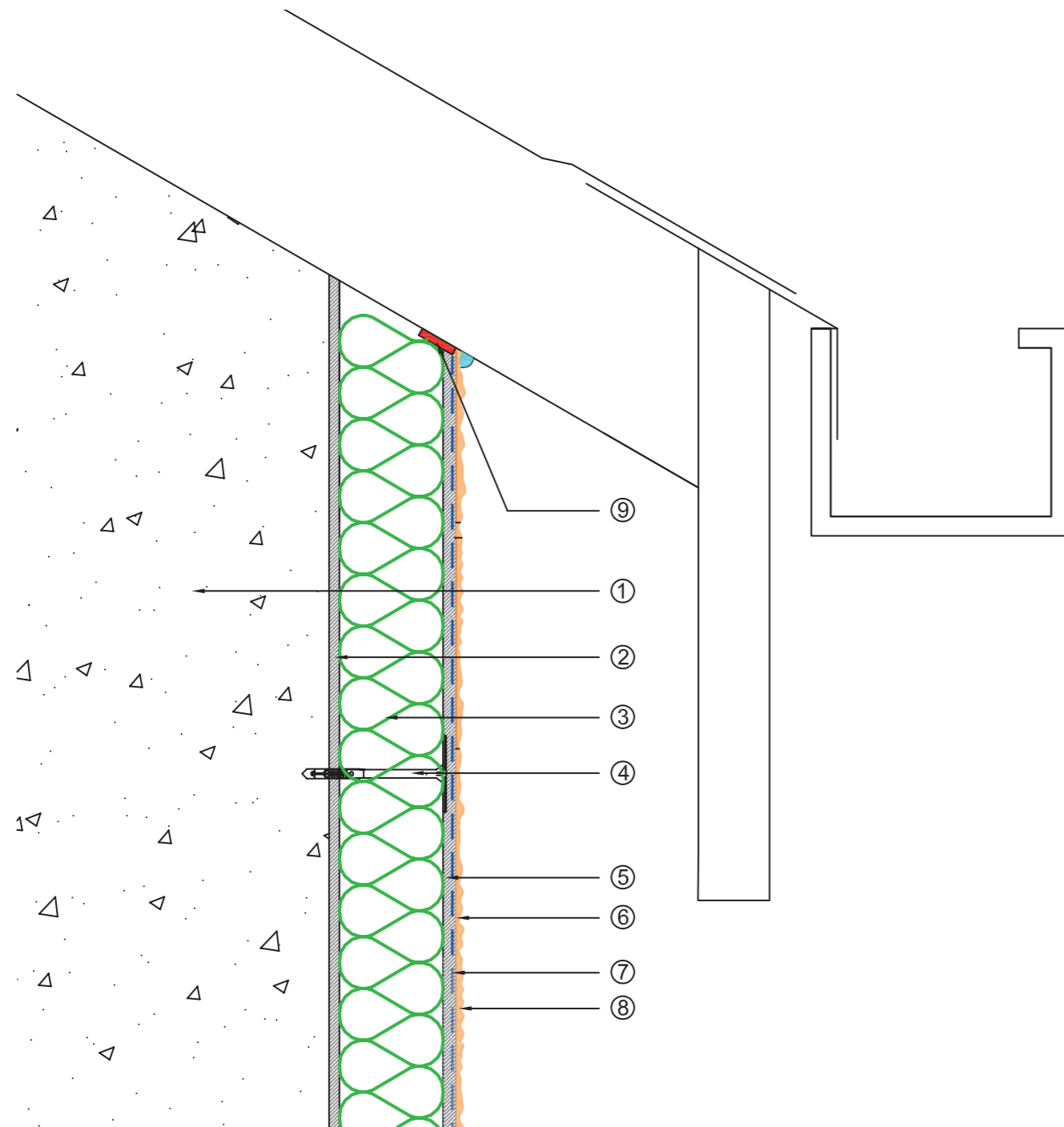

- | | |
|---|---|
| 1. Masonry Substrate | 7. MAPETHERM NET - Alkali resistant glass fibre mesh embedded into reinforcing coat |
| 2. MAPETHERM AR1 GG - Cementitious adhesive coat min 5-10mm | 8. SILANCOLOR TONACHINO or QUARZOLITE TONACHINO Top Coat Finish |
| 3. MAPETHERM EPS - Available in thickness 40mm-300mm | 9. Sealing Strip |
| 4. Mechanical fixings - ETA approved min embedment 40mm | |
| 5. MAPETHERM AR1 GG - Cementitious base coat applied min 4mm | |
| 6. MAPETHERM PRIMER - Coloured silicate /siloxane or acrylic primer | |

WINDOW HEAD DETAIL FOR MASONRY

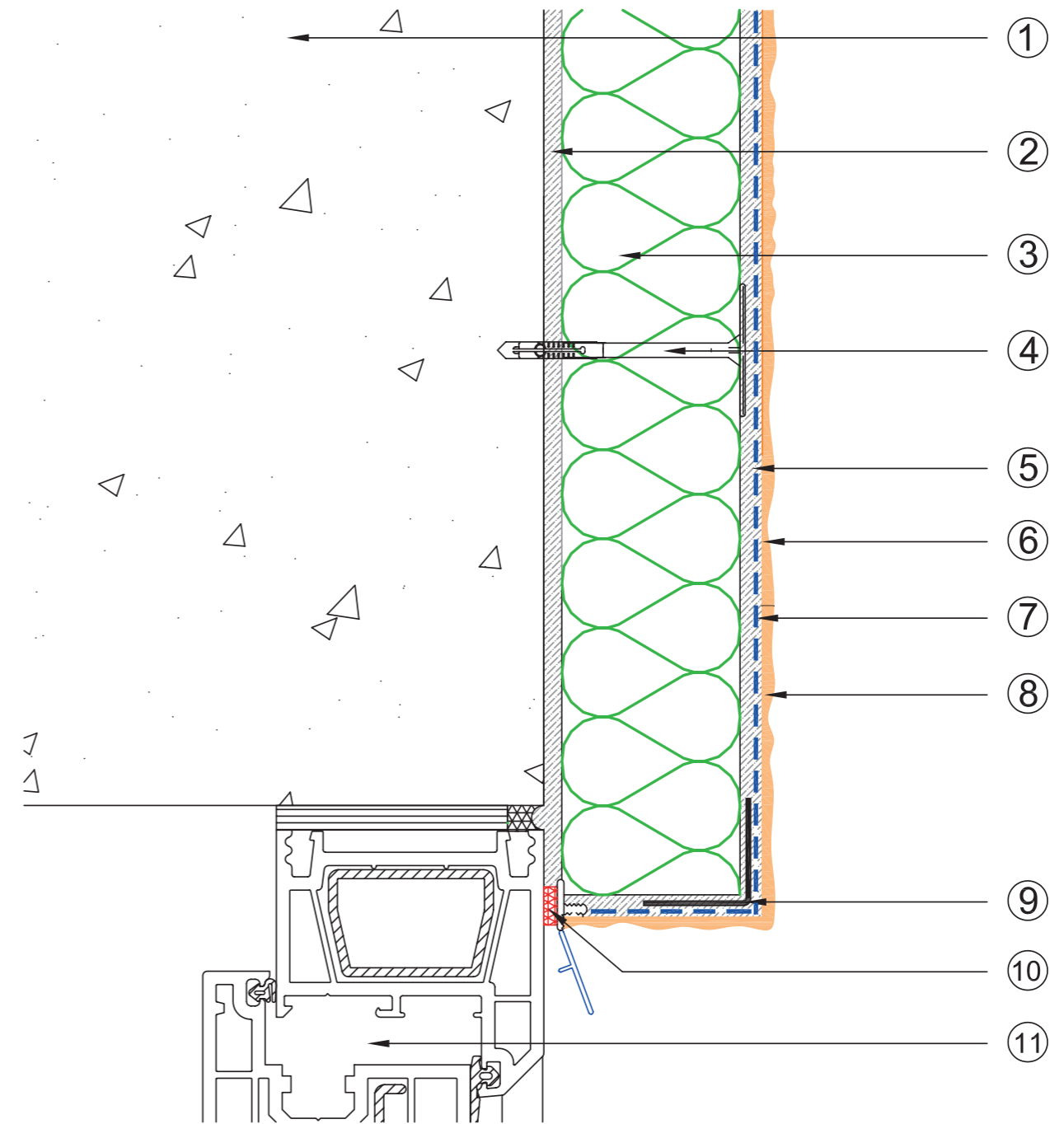

- | | |
|---|---|
| 1. Masonry Substrate | 7. MAPETHERM NET - Alkali resistant glass fibre mesh embedded into reinforcing coat |
| 2. MAPETHERM AR1 GG - Cementitious adhesive coat min 5-10mm | 8. SILANCOLOR TONACHINO or QUARZOLITE TONACHINO Top Coat Finish |
| 3. MAPETHERM EPS - Available in thickness 40mm-300mm | 9. External Meshed Corner Bead |
| 4. Mechanical fixings - ETA approved min embedment 40mm | 10. APU Bead or Sealing Strip |
| 5. MAPETHERM AR1 GG - Cementitious base coat applied min 4mm | 11. Typical Window Head Detail |
| 6. MAPETHERM PRIMER - Coloured silicate /siloxane or acrylic primer | |

MAPETHERM - EXTERNAL THERMAL INSULATION COMPOSITE SYSTEM FOR BUILDINGS

Primer

SILEXCOLOR PRIMER modified potassium silicate primer in water solution.

Finish

SILEXCOLOR TONACHINO modified potassium silicate mineral, plaster applied by trowel.

Sealant

MAPESIL AC mildew resistant pure silicon sealant. Available in 26 colours plus transparent.

Auxiliary components

MAPETHERM Ba aluminium support profiles with drip channels.

MAPETHERM FIX B nylon plugs for support profiles.

MAPETHERM PROFIL aluminium angular profiles to protect edges and corners.

MAPETHERM FIX 9, 60, 80 and 100 anchors for fastening insulating panels.

MAPEFOAM extruded polyethylene foam cord for flexible joints.

7.2 MAPETHERM EPS SYSTEM



ETA 10/0025 issued by the OIB Institut in Vienna.

BBA 13/4977

DETAILS OF THE SYSTEM

Adhesive and smoothing and levelling compound in powder form

MAPETHERM AR1 GG one-component, large-grained cementitious mortar in powder form, available in grey and white for bonding and reinforcing insulating panels.

Insulating panel

MAPETHERM EPS insulating panels in EPS 100 polystyrene, available in thicknesses from 40 to 300 mm.



Reinforcement

MAPETHERM NET primed, alkali-resistant glass fibre mesh (according to test method ETAG004).

Primer

SILEXCOLOR PRIMER coloured silicate undercoat with high filling properties for evening out surfaces, according to DIN 18363 Standards.
SILANCOLOR PRIMER coloured siloxane undercoat with high filling properties for evening out surfaces.

QUARZOLITE PRIMER coloured acrylic undercoat for filling and evening out surfaces.

Finish

SILEXCOLOR TONACHINO modified potassium silicate mineral plaster applied by spatula.

SILANCOLOR TONACHINO silicone resin plaster applied by trowel.

QUARZOLITE TONACHINO acrylic resin plaster applied by trowel.

MAPESIL AC mildew resistant pure silicon sealant. Available in 26 colours plus transparent.

Auxiliary components

MAPETHERM Ba aluminium starter / base track.

MAPEFOAM extruded polyethylene foam cord for flexible joints.

MAPETHERM PROFILE MESH aluminium angular profiles to protect edges and corners.

MAPETHERM PROFILE pre-mounted aluminium angle iron incorporated with alkali-resistant glass fibre mesh.

MAPETHERM APU FRAME SEAL PVC sealing bead.

MAPETHERM FIX BASE hammer fixing.

MAPETHERM FIX FIRE fire fixing.

MAPETHERM FIX stud for fixing insulating panels and composite insulating systems in place, with a plug with a metal/nylon pin and polypropylene body.

MAPETHERM CLIP extension clip for Mapetherm BA.

MAPETHERM - EXTERNAL THERMAL INSULATION COMPOSITE SYSTEM FOR BUILDINGS

MAPETHERM EPS PLUS SYSTEM



ETA 10/0025

DETAILS OF THE SYSTEM

Adhesive and smoothing and levelling compound in powder form

MAPETHERM AR1 GG one-component, large-grained cementitious mortar in powder form, available in grey and white for bonding and smoothing insulating panels.

Insulating panel

MAPETHERM EPS PLUS insulating panels in EPS Premium, available in thicknesses from 40mm to 300mm.

Reinforcement

MAPETHERM NET primed, alkali-resistant glass fibre mesh (according to test method ETAG004).

Primer

SILEXCOLOR PRIMER coloured silicate undercoat with high filling properties for evening out surfaces, according to DIN 18363 Standards.

SILANCOLOR PRIMER coloured silicate undercoat with high filling properties for evening out surfaces.

QUARZOLITE PRIMER coloured acrylic undercoat for filling and evening out surfaces.

Finish

SILEXCOLOR TONACHINO modified potassium silicate mineral plaster applied by spatula.

SILANCOLOR TONACHINO siloxane resin plaster applied by trowel.

QUARZOLITE TONACHINO acrylic resin plaster applied by trowel.

MAPESIL AC mildew resistant pure silicon sealant. Available in 26 colours plus transparent.

Auxiliary components

MAPETHERM Ba aluminium support profiles with drip channels.

MAPETHERM FIX B nylon plugs for support profiles.

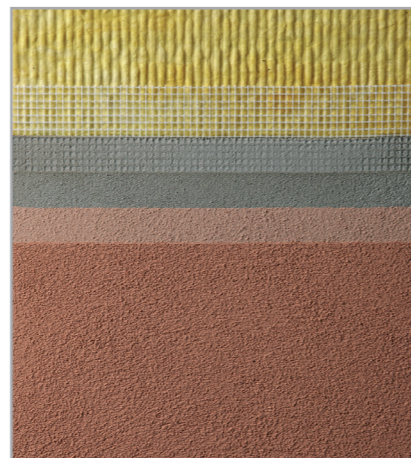
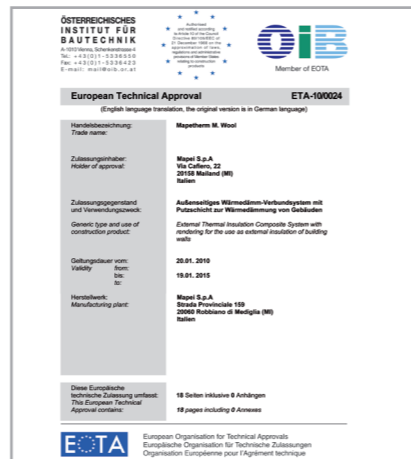

MAPETHERM PROFIL aluminium angular profiles to protect edges and corners.

MAPETHERM Ba PACKERS plastic packers for alignment.

MAPETHERM PROFILE MESH aluminium angular profiles to protect edges and corners.

MAPETHERM PROFILE pre-mounted aluminium angle iron incorporated with alkali-resistant glass fibre mesh.

MAPETHERM APU FRAME SEAL APU (PUC sealing band)

MAPETHERM FIX BASE hammer fixing.

MAPETHERM FIX FIRE fire fixing.

MAPETHERM FIX stud for fixing insulating panels and composite insulating systems in place, with a plug with a metal/nylon pin and polypropylene body.

MAPETHERM CLIP extension clip for Mapetherm BA.



7.3 MAPETHERM M. WOOL SYSTEM



ETA 10/0024 issued by the OIB Institut in Vienna

DETAILS OF THE SYSTEM

Adhesive and smoothing and levelling compound in powder form

MAPETHERM AR1 GG one-component, large-grained cementitious mortar in powder form, available in grey and white for bonding and smoothing insulating panels.

Insulating panel

MAPETHERM M. WOOL mineral wool insulating panel in thicknesses from 40 to 240 mm.

Reinforcement

MAPETHERM NET primed, alkali-resistant glass fibre mesh (according to test method ETAG004).

MAPETHERM - EXTERNAL THERMAL INSULATION COMPOSITE SYSTEM FOR BUILDINGS

Primer

SILANCOLOR PRIMER coloured silicon undercoat dispersion with high filling properties for evening out surfaces.

QUARZOLITE PRIMER coloured acrylic undercoat for filling and evening out surfaces.

Finish

SILANCOLOR TONACHINO silicon resin render, applied by trowel.

QUARZOLITE TONACHINO acrylic resin render, applied by trowel.

Sealant

MAPESIL AC mildew resistant pure silicon sealant. Available in 26 colours plus transparent.

Auxiliary components

MAPETHERM Ba aluminium support profiles with drip channels.

MAPETHERM FIX B nylon plugs for support profiles.

MAPETHERM PROFIL aluminium angular profiles to protect edges and corners.

MAPEFOAM extruded polyethylene foam cord for flexible joints.



MAPETHERM AR1 GG

8. SPECIFICATIONS

8.1 ADHESIVES AND SMOOTHING AND LEVELLING COMPOUNDS

MAPETHERM AR 1 GG (ADHESIVE AND SMOOTHING AND LEVELLING COMPOUND)

Bonding and basecoat and levelling of insulating panels is carried out using one-component cementitious mortar with selected sand, synthetic resin and special, fine-grained 0.6 mm additives (such as **MAPETHERM AR1 GG** produced by MAPEI S.p.A.). When this product is used for bonding, it must be applied directly on the back of the panels in an even layer using a 10 mm notched trowel if the substrate is flat. When used for smoothing and levelling, it must be applied with a smooth trowel directly on the insulating panel, and alkali-resistant glass fibre mesh (such as **MAPETHERM NET** produced by MAPEI S.p.A.) must be embedded in the mortar. The product must have the following performance characteristics:

Mixing ratio: 100 parts of **MAPETHERM AR1 GG** with 20-24 parts in weight of water

Density of mix (g/cm³): 1.40

pH of mix: 13

Workability time: 3 hours

Dry solids content: 100%

TECHNICAL DATA AS ADHESIVE

Consumption for bonding insulating panels with a uniform layer on the back of the panel:

with a No. 10 notched trowel: 10: 4-6 kg/m²

TECHNICAL DATA AS SMOOTHING AND LEVELLING COMPOUND

Consumption: 1.3 – 1.5 kg/m² per mm of thickness;

recommended thickness minimum 4 mm.

MAPETHERM - EXTERNAL THERMAL INSULATION COMPOSITE SYSTEM FOR BUILDINGS

8.2 INSULATING PANELS

MAPETHERM XPS

Supply and application of insulating panels in extruded polystyrene. The panels are cut at right-angles with no framework and measure 1200 x 600 mm. They conform to UNI EN 13164 standards and Euroclass E fire reaction class and have a thermal conductivity coefficient λ of 0.032-0.036 (such as **MAPETHERM XPS** marketed by MAPEI S.p.A). Their thickness is xxx mm, as per design value.

MAPETHERM M. WOOL

Supply and application of insulating panels in mineral wool measuring 1200 x 600 mm. They conform to UNI EN 13162 standards and Euroclass A2 s1 d0 minimum fire reaction class and have a thermal conductivity coefficient λ of 0.032-0.048 (such as **MAPETHERM M. WOOL** marketed by MAPEI S.p.A). Their thickness is up to 240 mm, as per design value.

MAPETHERM EPS

Supply and application of **EPS 100** fire-retardant polystyrene panels. The panels are cut at right-angles with no framework and measure 1000 x 500 mm. They conform to UNI EN 13163 standards and Euroclass E fire reaction class and have a thermal conductivity coefficient λ of 0.034-0.040 (such as **MAPETHERM EPS** marketed by MAPEI S.p.A). Their thickness is up to 300 mm, as per design value.

MAPETHERM CORK

Supply and application of insulating panels in expanded natural brown cork with no chemical binders measuring 1000 x 500 mm. They conform to UNI EN 13170 standards and Euroclass E fire reaction class and have a thermal conductivity coefficient λ of 0.040-0.048 (such as **MAPETHERM CORK** marketed by MAPEI S.p.A). Their thickness is xxx mm, as per design value.
N.B. the technical data of each product refer to those declared by the



MAPETHERM AR1 GG

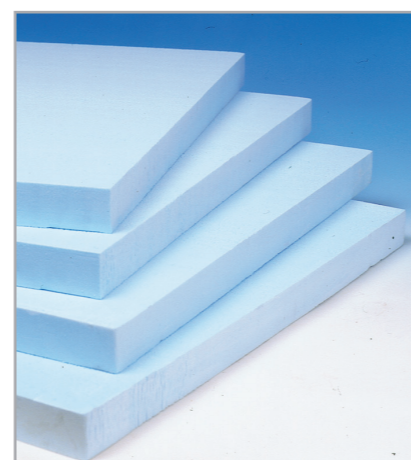

MAPETHERM XPS



MAPETHERM M. WOOL

manufacturers.

MAPETHERM NET (GLASS FIBRE REINFORCEMENT MESH)

The reinforced basecoat and levelling layer is formed by using glass fibre mesh treated with a special alkali-resistant primer which also improves bonding, resistance to temperature changes and abrasion. This mesh is tested according to the ETAG 004 test method.

Composition: 82% woven glass fibres, 18% anti-alkali primer

- Colour: blue
- Weight: 150 g/m² ± 5%
- Weight of glass per m² (ash content): 126 g/m² ± 5%
- Transversal tensile strength: 35 N/mm
- Longitudinal tensile strength: 35 N/mm
- Elongation at transversal failure: 5% ± 1%
- Elongation at longitudinal failure: 5% ± 1%

N.B. the technical data of each product refer to those declared by the manufacturers.

8.3 BASE PRIMERS FOR SURFACE PREPARATION

SILEXCOLOR PRIMER

The substrate is prepared by applying a primer of modified potassium silicate paint in water dispersion (such as **SILEXCOLOR PRIMER** produced by MAPEI S.p.A), which is used to even out the absorbency of the substrate before applying the finishing coat.

The base product must have the following characteristics:

- Consistency: fluid liquid
- Colour: transparent, colourless
- Density (g/cm³): 0.9
- Viscosity (Ø4 Ford beaker): 30 seconds
- Dry solids content: 14%
- Dilution rate: supplied ready to use



MAPETHERM - EXTERNAL THERMAL INSULATION COMPOSITE SYSTEM FOR BUILDINGS

- Drying time: 5-6 hours at 20°C
- Waiting time before painting over: 12 hours at +20°C
- Consumption: 50-100 g/m²

SILANCOLOR PRIMER

The substrate must be prepared using a high-penetration, silicon resin primer in water dispersion for new, well-cured substrates and old substrates as long as they are not particularly absorbent (such as **SILANCOLOR PRIMER** produced by MAPEI S.p.A).

The product is applied by brush, roller or spray.

The product must have the following characteristics:

- Dry solids content (%): 12
- Density (g/cm³): approx. 1.01
- Average theoretical consumption (g/m²): 100-150
- Drying time: 24 hours at +20°C
- Waiting time before painting over: 24 hours at +20°C

MALECH

The substrate must be prepared using a high-penetration, micronised acrylic resin fixing primer in water dispersion for new, well-cured substrates and old substrates as long as they are not particularly absorbent (such as **MALECH** produced by MAPEI S.p.A).

The product is applied by brush, roller or spray.

The product must have the following characteristics:

- Dry solids content (%): 15
- Density (g/cm³): approx. 1.01
- Average theoretical consumption (g/m²): 100-150
- Drying time: 24 hours at +20°C
- Waiting time before painting over: 24 hours at +20°C

QUARZOLITE PRIMER

New, well-cured render, old render in good condition, old paintwork, even



MAPETHERM EPS



MAPETHERM CORK



SILEXCOLOR PRIMER

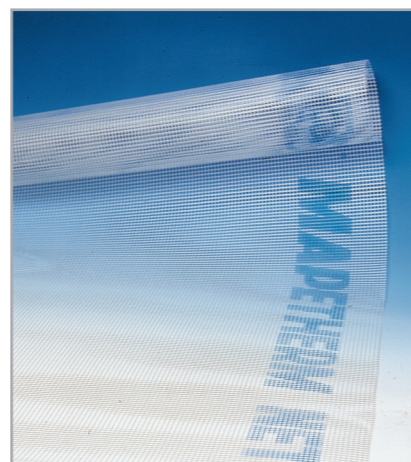

MAPETHERM NET



SILANCOLOR PRIMER

if slightly flaky, and thermal insulation systems must be prepared using a coloured acrylic undercoat with good covering and filling properties (such as **QUARZOLITE PRIMER** produced by MAPEI S.p.A.). At least one coat of the product must be applied by brush, roller or spray. The base coat must have the following characteristics:

- Colour: as specified by the Works Director or according to the manufacturer's colour chart
- Appearance: thick liquid
- Viscosity (mPa•s): 17,000 ± 1000
- Dry solids content (%): 65 ± 2
- Density (g/cm³): 1.68 ± 0.02
- Consumption (kg/m²): 0.4– 0.5 per coat
- Vapour diffusion resistance coefficient (μ) (UNI EN ISO 7783): 428
- Resistance to the passage of vapour of a 0.15 mm thick dry layer Sd (UNI EN ISO 7783): 0.06
- Capillary action water absorption coefficient W24 [kg/(m²h^{0.5})] (UNI EN 1062-3): 0.53

SILEXCOLOR PRIMER

New, well-cured render, de-humidifying render, old render in good condition, old paintwork, even if slightly flaky, and thermal insulation systems must be prepared using a coloured silicate undercoat (such as **SILEXCOLOR PRIMER** produced by MAPEI S.p.A.). At least one coat of the product must be applied by brush, roller or spray. The base coat must have the following characteristics:

- Colour: as specified by the Works Director or according to the manufacturer's colour chart
- Appearance: thick liquid
- Viscosity (mPa•s): 18,500 ± 1000
- Dry solids content (%): 65 ± 2
- Density (g/cm³): 1.61 ± 0.02

MAPETHERM - EXTERNAL THERMAL INSULATION COMPOSITE SYSTEM FOR BUILDINGS

- Consumption (kg/m²): 0.4 – 0.5 per coat.

- Vapour diffusion resistance coefficient (μ)

(UNI EN ISO 7783): 149

- Resistance to the passage of vapour of a 0.15 mm thick dry layer Sd (UNI EN ISO 7783): 0.02

- Capillary action water absorption coefficient W24

[kg/(m²h^{0.5})] (UNI EN 1062-3): 0.80

SILANCOLOR PRIMER

New, well-cured render, old render in good condition, old paintwork, even if slightly flaky, and thermal insulation systems must be prepared using a coloured silicone undercoat with good covering and filling properties (such as **SILANCOLOR PRIMER** produced by MAPEI S.p.A.). At least one coat of the product must be applied by brush, roller or spray. The base coat must have the following characteristics:

- Colour: as specified by the Works Director or according to the manufacturer's colour chart

- Appearance: thick liquid

- Viscosity (mPa·s): 17,000 ± 1000

- Dry solids content (%): 65 ± 2

- Density (g/cm³): 1.68 ± 0.02

- Consumption (kg/m²): 0.4 – 0.5 per coat

- Vapour diffusion resistance coefficient (μ)

(UNI EN ISO 7783): 300

- Resistance to the passage of vapour of a 0.15 mm thick dry layer Sd

(UNI EN ISO 7783): 0.04

- Capillary action water absorption coefficient W24

[kg/(m²h^{0.5})] (UNI EN 1062-3): 0.24

$Sd \cdot W = 0.04 \times 0.24 = 0.0096$ [Kg/(m²h^{0.5})]

The value of Sd x W is less than 0.1, therefore Silancolor Base Coat respects Kuenzle's Theory (DIN 18550)

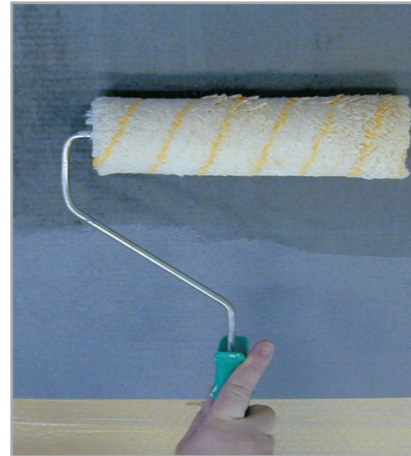

MALECH



MALECH



QUARZOLITE BASE COAT



SILEXCOLOR BASE COAT



8.4 FINISHING PRODUCTS

SILEXCOLOR PRIMER

Application of one-component modified potassium silicate mineral plaster (such as **SILEXCOLOR TONACHINO** produced by MAPEI S.p.A.) applied in one or more 1 mm thick coats after applying a suitable primer (such as **SILEXCOLOR PRIMER** produced by MAPEI S.p.A.).

The finishing product must have the following characteristics:

- Colour: as specified by the Works Director or according to the manufacturer's colour chart

- Appearance: paste

- Dry solids content: 80%

- Density (g/cm³): approx. 1.75

- Consumption: 2-2.5 kg/m²

- Preparation: supplied ready to use

- Dust dry: 20-30 minutes in open air

- Waiting time before painting over: 12-24 hours

- Vapour diffusion resistance coefficient μ (DIN 52615): 39

- Resistance to passage of vapour of a 1.5 mm thick layer in equivalent metres of air Sd (DIN 52615): 0.059 m

- Capillary action water absorption coefficient W (DIN 52617): 0.09 kg/(m²h^{0.5})

- Consumption (kg/m²): 2.0 – 3.5 (according to grain size of the product and roughness of substrate)

SILEXCOLOR PAINT

Painting of render, de-humidifying render and general cementitious surfaces by applying highly transparent, modified potassium silicate paint (such as **SILEXCOLOR PAINT** produced by MAPEI S.p.A.). At least two coats of the product must be applied using a brush, roller or by air-spray after applying a suitable primer (such as **SILEXCOLOR PRIMER** produced by MAPEI S.p.A.).

The finishing product must have the following characteristics:

MAPETHERM - EXTERNAL THERMAL INSULATION COMPOSITE SYSTEM FOR BUILDINGS

- Colour: as specified by the Works Director or according to the manufacturer's colour chart
- Dry solids content (%): 55
- Density (g/cm³): approx. 1.46
- Vapour diffusion resistance coefficient μ (DIN 52615): 214
- Resistance to passage of vapour of a 100 μ m-thick layer in equivalent metres of air (Sd) (DIN 52615): 0.02
- Capillary action water absorption coefficient W (DIN 52617) in kg/(m²•h^{0.5}): 0.12
- Waiting time before painting over: 12 hours (at +20°C)
- Consumption (kg/m²): 0.35 – 0.45 (for two coats and according to the roughness of the substrate).

SILANCOLOR TONACHINO

Coating of render, de-humidifying render, general cementitious surfaces and old paintwork by applying highly transpirant, highly water-repellent silicon resin render (such as **SILANCOLOR TONACHINO** produced by MAPEI S.p.A.). The product must be applied in one coat using a stainless steel trowel after applying a suitable primer (such as **SILANCOLOR PRIMER** produced by MAPEI S.p.A.).

The finishing product must have the following characteristics:

- Colour: as specified by the Works Director or according to the manufacturer's colour chart
- Density (g/cm³): 1.69
- Dry solids content (%): 80
- Vapour diffusion resistance coefficient (m) (DIN 52615): 178
- Resistance to passage of vapour of a 1.5 mm-thick layer in equivalent metres of air Sd (m) (DIN 52615): 0.267
- Capillary action water absorption coefficient W24 (kg/(m²h^{0.5})) (DIN 52617): 0.12
- Waiting time before applying other coats: 12-24 hours
- Consumption (kg/m²): 2.0 – 2.5 (according to grain size of the product and



SILANCOLOR BASE COAT



SILEXCOLOR TONACHINO



SILEXCOLOR PAINT



roughness of substrate)

SILANCOLOR PAINT

Painting of render, de-humidifying render, general cementitious surfaces and re-painting old paintwork by applying highly transpirant, highly water-repellent silicone paint (such as **SILANCOLOR PAINT** produced by MAPEI S.p.A.). At least two coats of the product must be applied using a brush, roller or by air-spray after applying a suitable primer (such as **SILANCOLOR PRIMER** produced by MAPEI S.p.A.).

The finishing product must have the following characteristics:

- Colour: as specified by the Works Director or according to the manufacturer's colour chart
- Dry solids content (%): 65
- Density (g/cm³): approx. 1.55
- Vapour diffusion resistance coefficient (μ) (DIN 52615): 600
- Capillary action water absorption coefficient W24 (kg/(m²h^{0.5})) (DIN 52617): 0.06
- Waiting time before applying other coats: 24-48 hours
- Consumption (g/m²): 200-300 (according to the roughness of the substrate)

QUARZOLITE TONACHINO

Coating of render, painted render and general cementitious surfaces, including those already painted, by applying acrylic resin render (such as **QUARZOLITE TONACHINO** produced by MAPEI S.p.A.). The product must be applied in one or more coats using a stainless steel trowel after applying a suitable primer (such as **MALECH** produced by MAPEI S.p.A.).

The finishing product must have the following characteristics:

- Colour: as specified by the Works Director or according to the manufacturer's colour chart
- Density (g/cm³): 1.75
- Dry solids content (%): 85
- Waiting time before applying other coats: 12-24 hours

MAPETHERM - EXTERNAL THERMAL INSULATION COMPOSITE SYSTEM FOR BUILDINGS

- Dilution ratio: supplied ready to use
- Resistance to passage of vapour of a 1.5 mm thick layer in equivalent metres of air Sd (m) (DIN 52615): 0.165
- Capillary action water absorption coefficient W24 (kg/(m²h^{0.5})) (DIN 52617): 0.97
- Consumption (kg/m²): 2.5 – 3.0 (according to grain size of the product and roughness of substrate)

QUARZOLITE PAINT

Painting of render, painted render and general cementitious surfaces, including those already painted, by applying acrylic paint with micro- quartz (such as **QUARZOLITE PAINT** produced by MAPEI S.p.A.). At least two coats of the product must be applied using a brush, roller or by air-spray after applying a suitable primer (such as **MALECH** produced by MAPEI S.p.A.).

The finishing product must have the following characteristics:

- Colour: as specified by the Works Director or according to the manufacturer's colour chart
- Appearance: thick liquid
- Dry solids content (%): 66
- Density (g/cm³): approx. 1.55
- Theoretical yield (m²/kg): 2-3
- Damp abrasion DIN 53778: > 5,000 cycles
- Change in colour (blue) after 800 hours exposure to a Weather-Ometer: E < 2
- Vapour diffusion resistance coefficient Sd (m) (DIN 52615): 0.30
- Capillary action water absorption coefficient W24 (kg/(m²h^{0.5})) (DIN 52617): 1.21

WARNING

While the technical details and recommendations mentioned above correspond to the best of our knowledge and experience, all the above



SILANCOLOR TONACHINO



information must, in every case, be taken as merely indicative and subject to confirmation after long-term, practical applications. For this reason, anyone who intends using these systems must ensure beforehand that they are suitable for the envisaged application and, in all cases, the user alone is fully responsible for any consequences deriving from their use.

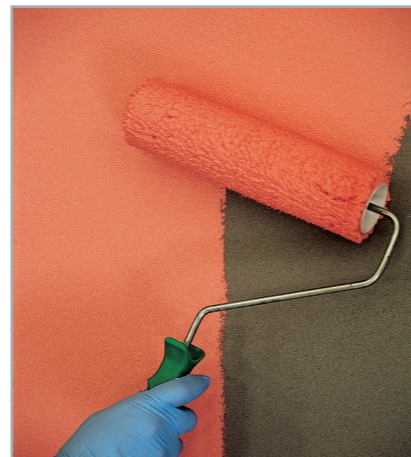

SILANCOLOR PAINT



QUARZOLITE TONACHINO



on caused by micro-organisms in the building

