



# Ecophon Akusto™ Wall Edge A

Ecophon Akusto™ Wall A has an exposed profile system with a variety of surface options. This wall absorber pairs with a sound absorbing ceiling to achieve excellent acoustic properties in the room.



P20 Office & Business, Poland

## SYSTEM RANGE

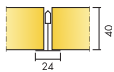

Size, mm	2700x1200
Channel trim	•
Thinline Profile	•
Thickness	40
Inst. Diagr.	M353, M504, M593, M595

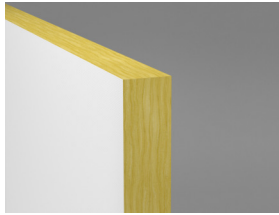

Akusto Wall A

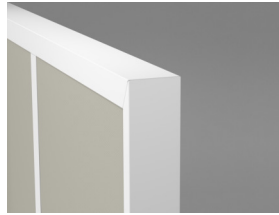

Akusto Wall A system with Connect Channel trim and Connect T24 Main runner

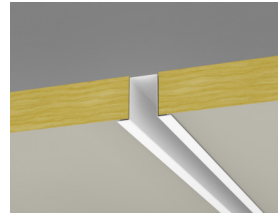

Akusto Wall A system with Connect Channel trim and Connect Recessed profile



Akusto Wall system with Connect Thinline profiles

## Acoustic



### Sound Absorption:

Test results according to EN ISO 354. Classification according to EN ISO 11654, and the single value ratings for Noise Reduction Coefficient, NRC and Sound Absorption Average, SAA according to ASTM C 423.

$\alpha_p$ , Practical sound absorption coefficient

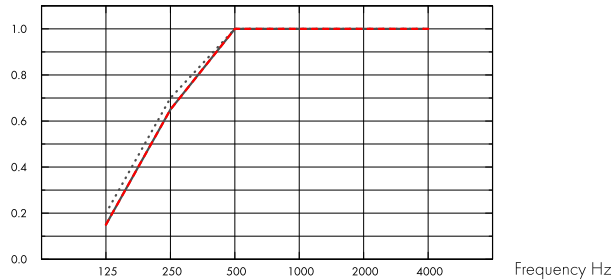

... Akusto Wall A Akutex FT 40 mm, 43 mm o.d.s.

— Akusto Wall A Texona 40 mm, 43 mm o.d.s.

--- Akusto Wall A Super G 40 mm, 43 mm o.d.s.

o.d.s = overall depth of system

	THK mm	o.d.s. mm	$\alpha_p$ , Practical sound absorption coefficient						$\alpha_w$	Sound absorption class
			125 Hz	250 Hz	500 Hz	1000 Hz	2000 Hz	4000 Hz		
Akutex FT	40	43	0.20	0.70	1.00	1.00	1.00	1.00	1.00	A
Texona	40	43	0.15	0.65	1.00	1.00	1.00	1.00	1.00	A
Super G	40	43	0.15	0.65	1.00	1.00	1.00	1.00	0.95	A

THK mm	AC[1.5]
40	Articulation Class, ASTM E1111, ASTM E1110 230

## Indoor Air Quality



Certificate / Label	Plant	
Eurofins Indoor Air Comfort®	IAC	IAC Gold
French VOC	A	A+
Finnish M1	•	•



## Environmental Footprint



	kg CO <sub>2</sub> equiv/m <sup>2</sup>
Akusto Wall A - Texona	4,74
Akusto Wall A - Texona/Plant	5,30
Akusto Wall A - Akutex FT	3,96
Akusto Wall A - Akutex FT/Plant	4,29
Akusto Wall A - Super G	6,21
Akusto Wall A - Super G/Plant	5,93

Life-cycle stages A1 to C4 from EPD, in conformity with ISO 14025 / EN 15804



### Circularity

Minimum post-consumer recycled content	53%
Recyclability	Fully recyclable



### Fire safety

Country	Class	
Europe	EN 13501-1	A2-s1,d0

The glass wool core of the tiles is tested and classified as non-combustible according to EN ISO 1182.



### Humidity Resistance

Product	
Standard	Class C, RH 95% and 30°C
Plant	Class A, RH 70% and 25°C

According to EN 13964:2014



### Visual appearance

Akusto Wall in white has high light reflectance. Light reflectance and nearest NCS colour sample for all the different colours: See Ecophon Colours and surfaces.



### Cleanability

Daily dusting, vacuum cleaning and weekly wet wiping (Super G and Akutex FT surfaces). Weekly dusting and vacuum cleaning (Texona surface) as required.



### Use of disinfectants

Texona Ginger, Sea salt, Thyme, Oyster and Garlic withstand the frequent use of ethanol (70%)-based disinfectants. Dampen a soft polyester microfiber cloth with the solution and wipe the surface in gentle circular movements.



### Accessibility

The tiles are not demountable except in selected installation diagrams. See quantity specification for more information.



### Installation

Installed according to installation diagrams, installation guides and drawing aid. For information regarding minimum overall depth of system see quantity specification. The systems should not be placed behind goals or similar areas where they are likely to be hit regularly. In such cases a protective net in front of the system is recommended.



### System weight

The weight of the system (including profile system) should be approximately 4 kg/m<sup>2</sup>.



### Mechanical properties

No additional live load is allowed.



## Impact Resistance

Surface	M-sketch
Super G	M353
	Fulfills

Tested and classified to fulfil the requirements of DIN 18032-3, equivalent to 1A according to EN13964. Texona surface has moderate impact resistance. Please note: Where the panels are subjected to frequent blows and impacts e.g. behind goal mouths, protection in form of e.g. restraining nets or wooden slats is required.



## CE

Ecophon ceiling systems are CE marked according to the European harmonized standard EN13964:2014. CE marked construction products are covered by a Declaration of Performance (DOP) which enables customers and users to easily compare performance of products available on the European market.

## INSTALLATION DIAGRAM (M353) FOR ECOPHON AKUSTO WALL A

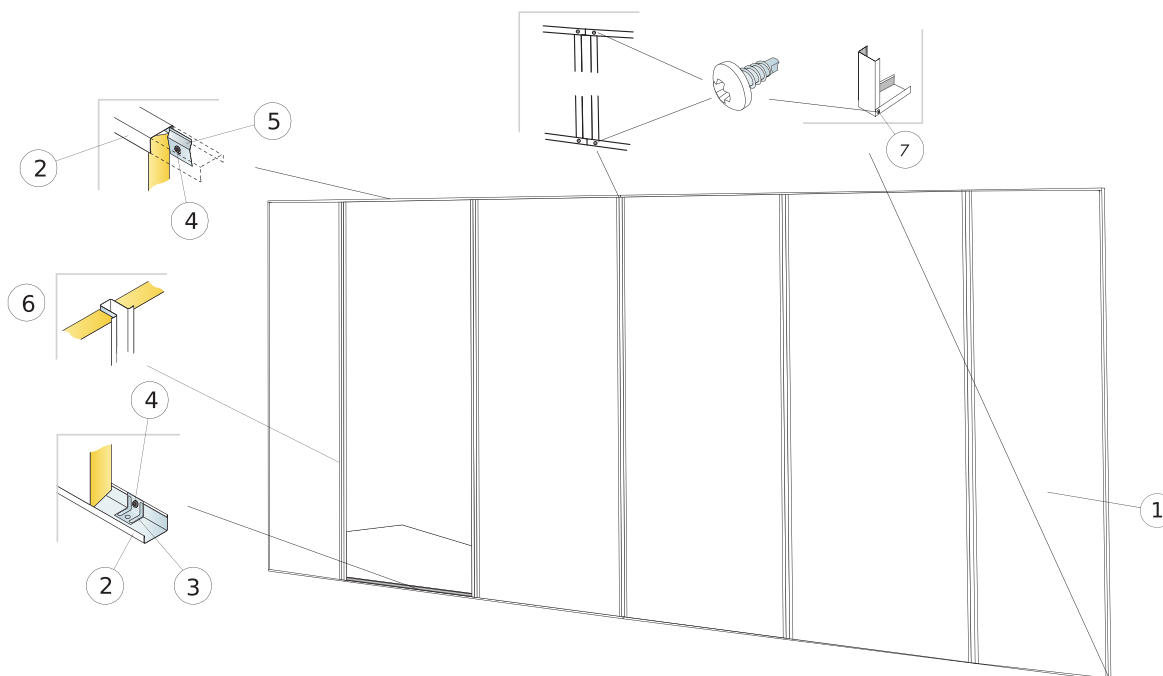

© Ecophon Group

### QUANTITY SPECIFICATION (EXCL. WASTAGE)

	Size, mm
	<b>2700x1200</b>
1 Ecophon Akusto Wall A/Super G	0,31/m <sup>2</sup>
2 Connect Channel trim, fixed at 300 mm centres. Connect Direct fixing plate is placed inside at each fixing point if the panel is not supported by the floor.	as required
3 Connect Direct fixing plate	as required
4 Connect Installation screw MVL (for use in plasterboard or timber)	as required
5 Connect Fixing bracket, fixed at 400 mm centres.	as required
6 Connect Recessed profile plus	as required
7 Connect Installation screw BR (2000 pcs)	as required
Δ Min. overall depth of system: 44 mm	-

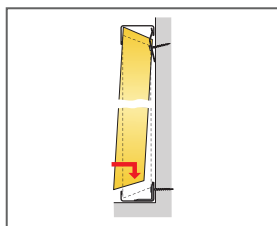
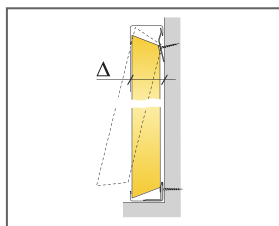

Detail of installation

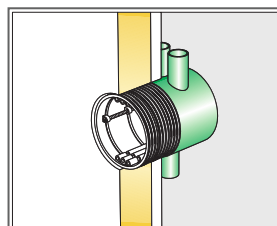

Accessories for adjusting electrical installations are available in electricity retail stores

Size, mm	Max live load (N)	Min load bearing capacity (N)
2700x1200x40	0	-

Live load/load bearing capacity

## INSTALLATION DIAGRAM (M504) FOR ECOPHON AKUSTO WALL A

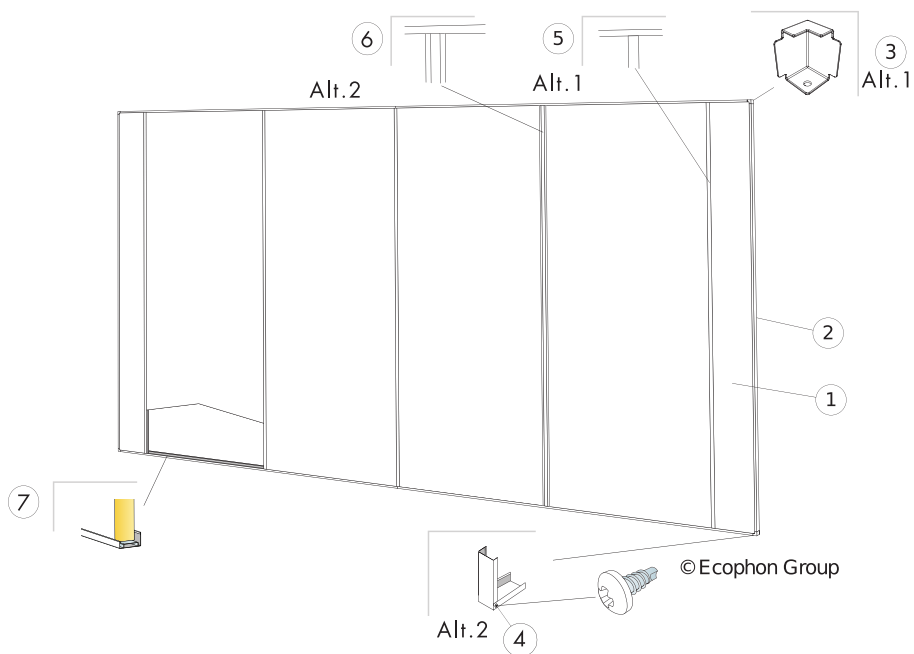

### QUANTITY SPECIFICATION (EXCL. WASTAGE)

	Size, mm
	<b>2700x1200</b>
1 Ecophon Akusto Wall A	0,31/m <sup>2</sup>
2 Connect Channel trim, fixed at 300 mm centres. Connect Direct fixing plate is placed inside at each fixing point if the panel is not supported by the floor.	as required
3 Alt. 1 Connect Channel trim corner	as required
4 Alt. 2 Connect Installation screw BR	as required
5 Alt. 1 Connect T24 Main runner, (Installation: kept in position with the Channel trims)	as required
6 Alt.1 Connect Recessed profile, (Installation: kept in position with the Channel trims)	as required
7 Connect WP Space bar, L=2400 mm	as required
Δ Min. overall depth of system: 44 mm	-
Connect Installation screw MVL (for use in plasterboard or timber)	as required

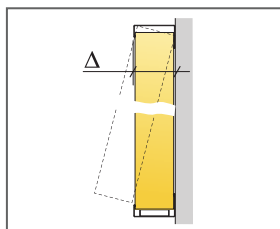

See Quantity specification

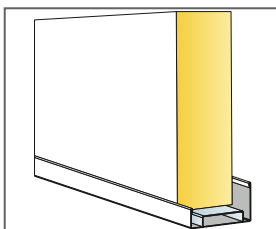

Installation with Channel trim and WP Space bar

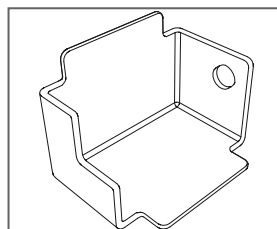

Connect Channel Trim corner for 44mm profile

Size, mm	Max live load (N)	Min load bearing capacity (N)
2700x1200x40	-	-

Live load/load bearing capacity

## INSTALLATION DIAGRAM (M593) FOR ECOPHON AKUSTO WALL A VERTICAL INSTALLATION WITH CONNECT THINLINE PROFILES.

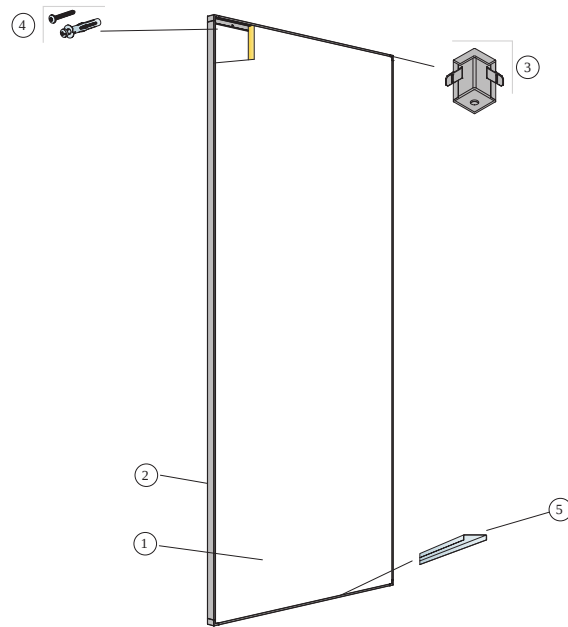

© Ecophon

### QUANTITY SPECIFICATION (EXCL. WASTAGE)

	<b>Size, mm</b>
	<b>2700x1200</b>
1 Ecophon Akusto Wall A	0,31/m <sup>2</sup>
2 Connect Thinline Profile, L=2658 mm	as required
3 Connect Thinline Corner	as required
4 Installation screw, installed at 400 mm centres [select fastener according to wall material]	as required
5 Connect Thinline Space Bar	as required
Δ Overall depth of system: 45 mm	-

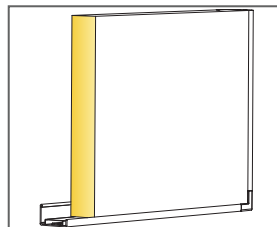
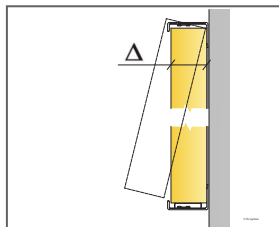

Detail of panel with Thinline frame

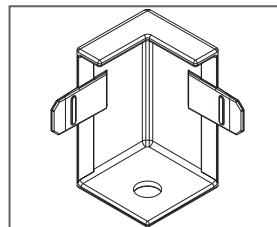

Detail of Thinline corner

Size, mm	Max live load (N)	Min load bearing capacity (N)
2700x1200x40	-	-

Live load/load bearing capacity

## INSTALLATION DIAGRAM (M595) FOR ECOPHON AKUSTO WALL A HORIZONTAL INSTALLATION WITH CONNECT THINLINE PROFILES.

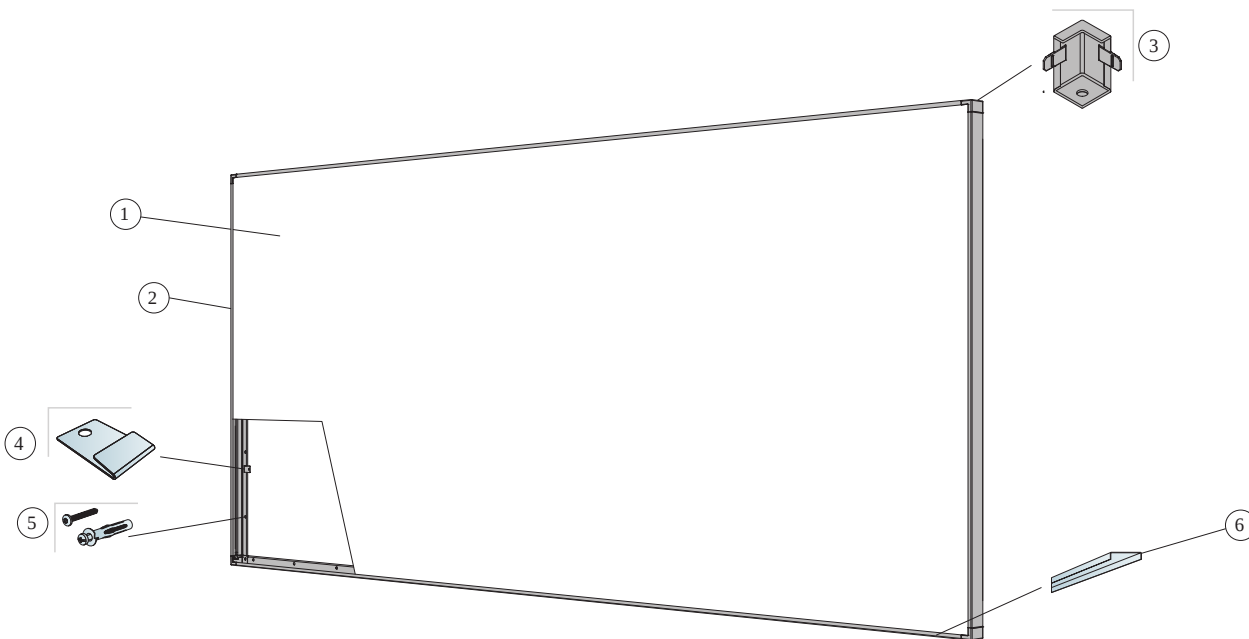

© Ecophon

### QUANTITY SPECIFICATION (EXCL. WASTAGE)

	<b>Size, mm</b>
	<b>2700x1200</b>
1 Ecophon Akusto Wall A	0,31/m <sup>2</sup>
2 Connect Thinline Profile, L=2658 mm	as required
3 Connect Thinline Corner	as required
4 Connect Thinline Locking Clip	as required
5 Installation screw, installed at 400 mm centres (select fastener according to wall material)	as required
6 Connect Thinline Space Bar	as required
Δ Overall depth of system: 45 mm	-

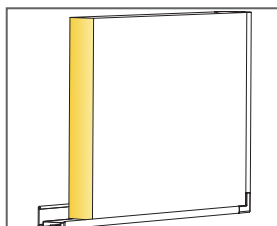
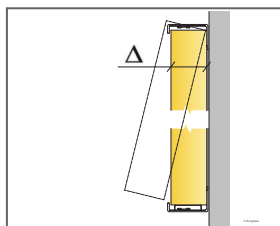

Detail of panel with Thinline frame

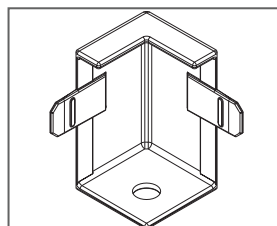

Detail of Thinline corner

Size, mm	Max live load (N)	Min load bearing capacity (N)
2700x1200x40	-	-

Live load/load bearing capacity