



XT Stair Edgings

Additional Profiles and Finishes

GRADUS

The Ultimate Stair Edging Solution...



Contents

4. Gradus XT Range

Overview
NBS Source

5. Developed in line with the latest guidance...

BRE - Research and Guidelines
BS 8300-2:2018
The Building Regulations 2010 - Approved Document M (ADM)

6. XT Bronze Stair Edgings

Channel finishes
Insert options
Bronze Stair Edgings

10. XT Aluminium Stair Edgings

Channel finishes
Insert options
Aluminium Stair Edgings

16. Associated Products for Stairs & Floors

Welded Corners with TC1 Clips
Welded Corners with Fixed Flange
Welded Corners with TC3 Clips
Nap Trims

16. Gradus Grip GG290 - Stair Edging Adhesive

17. FREE Measuring Service

17. Fabrication Service

17. Light Reflectance Values (LRVs) and NCS References

18. A Fusion of Products

Gerflor and Gradus offer products which are ideal for use in a wide variety of applications including hospitality & leisure, residential developments, retail and commercial office.

Gradus XT Range

Gradus XT is the ultimate stair edging solution, combining maximum safety, performance and aesthetics to reduce the risk of slips, trips and falls on stairs. **There is no equal.**

The introduction of our new XT Bronze profiles, new metal inserts, in addition to an enhanced range of finishes available across existing XT Aluminium profiles, offers an ideal solution for luxury hospitality & high-end residential applications.



Product specification data, product literature and BIM objects for our full XT range are available on NBS Source.



Developed in line with the latest guidance...

Supported by recommendations from **BRE** and the guidance contained within **BS 8300-2:2018** and **Approved Document M (ADM) of the Building Regulations 2000**, building owners and specifiers can choose Gradus XT safe in the knowledge that it offers the ultimate solution in product design and performance to protect all groups of building users.

The Gradus XT range features a unique insert design that extends around the entire leading edge of the stair edging to ensure that foot contact is always made with the slip-resistant element of the stair edging. This is in line with the recommendations published within **BRE (IP 15/03)** information paper, which provides guidance to designers and building managers selecting stair edgings for non-domestic stairs.



Ideal for use with **Gradus Grip (GG290)** ultra strong stair edging adhesive, see page 16

Extended insert design around the entire leading edge of the stair edging

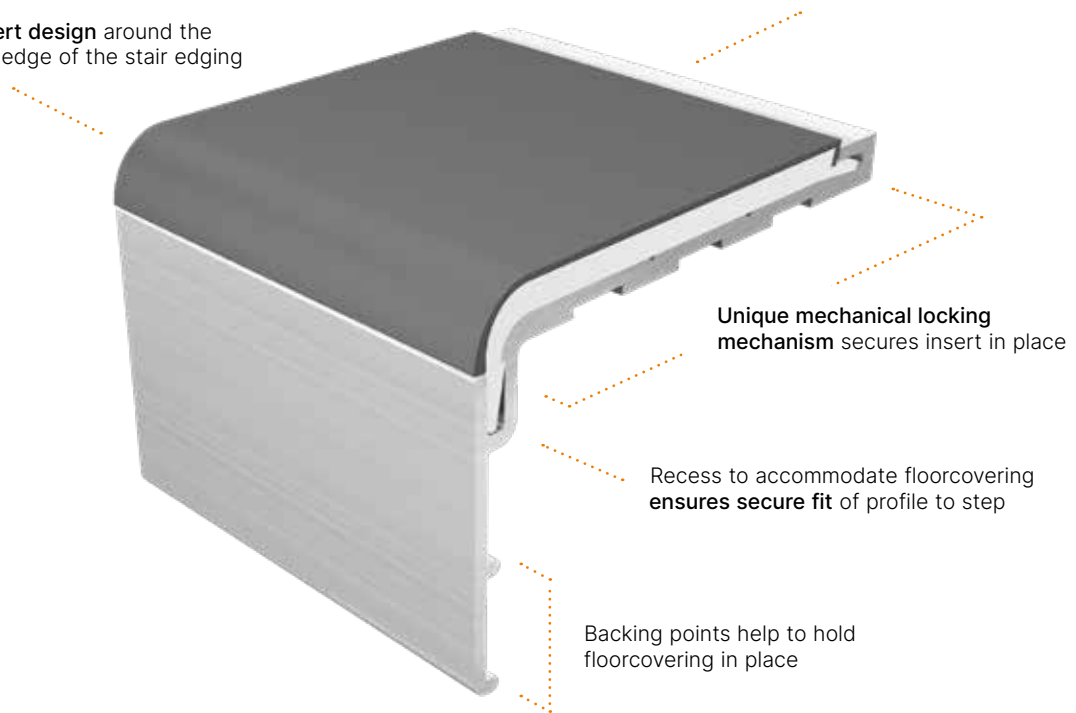

Guidance within BS 8300-2:2018 also states that 'The whole tread or the nosing should incorporate slip-resistant material, starting as close as practicable to the front edge of the nosing and extending the full width of the tread' (see diagram opposite).

Slip-resistance is further enhanced by a comprehensive choice of inserts and colours across our XT range, with options available to suit both dry and wet interior conditions. All our inserts are fully tested and achieve a **Pendulum Test Value of greater than 36**, which satisfies the requirements of BS 8300-2:2018.

The wide choice of insert colours & finishes **enable designers to achieve suitable colour contrast** with the surrounding floorcoverings in line with the guidance in ADM and BS 8300-2:2018. All Gradus products have been measured for Light Reflectance Values to ensure that sufficient contrast is achieved.



XT Bronze Stair Edgings

Our new XT Bronze stair edging range features Bronze channels available in Polished Bronze or Satin Bronze finishes. In addition to our Standard Interior finish and Xtra-grip inserts, we now offer metal castellated inserts that can be selected in a finish to match the channel or combined with a choice of contrasting finishes to create a unique look.

XT Bronze features all the existing benefits of XT including an extended insert design and insert locking mechanism, as illustrated on page 5.

Profiles are available in popular configurations to suit a variety of floorcoverings and step shapes.

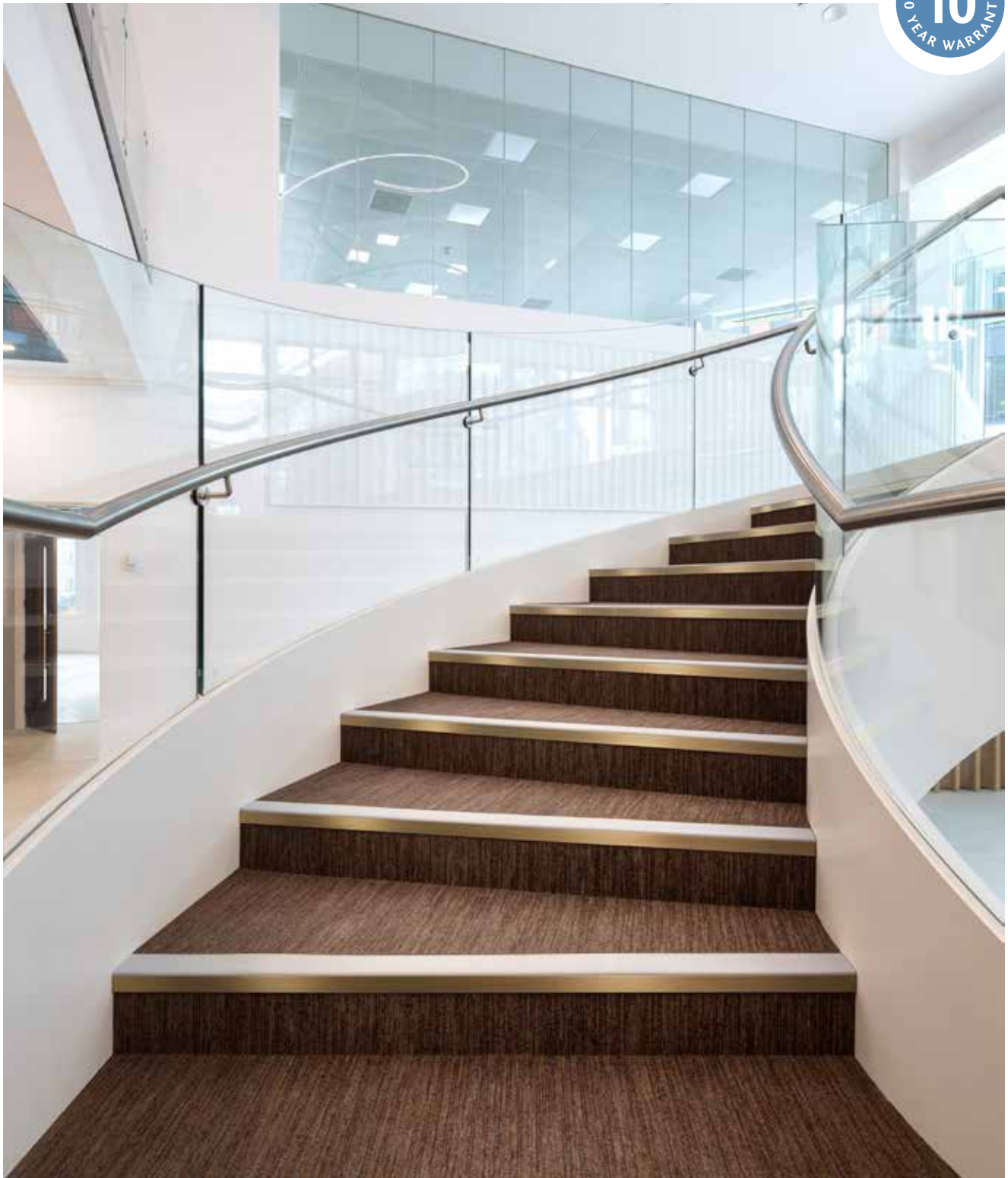

Channel and insert options



NEW

Bronze channel finishes

Our Polished Bronze finish creates a sleek appearance, whilst Satin Bronze offers a matt finish that features a subtle brushed effect.



3x Insert options



Interior Standard Finish

Conditions: Interior Dry
Material: Pvc with mineral inclusion

Areas where there is no risk that the stairs will be contaminated by moisture.



Xtra-grip

Conditions: Interior Dry / Interior Wet
Material: Pvc with mineral aggregate

Increased surface roughness where the stair edging may become wet e.g. stairs close to entrances.



NEW

Metal Castellated

Conditions: Interior Dry / Interior Wet
Material: Bronze or aluminium

Provides an all-metal solution that features a castellated design.

Jet 	Ink
▶ Evergreen 	▶ Teal
Burgundy 	▶ Ocean
▶ Spice 	Coffee
Lead 	▶ Bronze
Steel 	▶ Linen
Glacier 	Canvas
Wisp 	Clay
Sky 	Buttercup
Jade 	Snowdrift

Onyx 	Neptune
▶ Forest 	▶ Aegean
▶ Claret 	▶ Baltic
▶ Chestnut 	Umber
Graphite 	▶ Sepia
Quarry 	▶ Tuscan
Concrete 	Pumice
Surf 	Ochre
Bamboo 	Frost

Bronze:

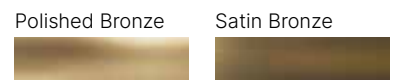

Aluminium:

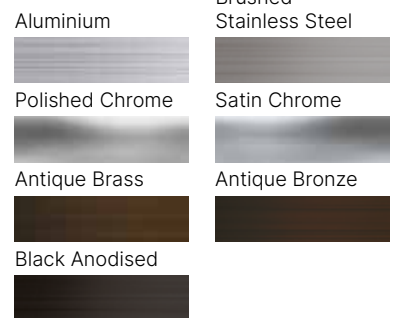

▶ New - Stock available January 2024

For Light Reflectance Values (LRVs) and NCS references see page 17.

Finishes depicted are representative only and are subject to print interpretation.

For accurate referencing, request a free sample by calling Gradus Technical Support on 01625 428922.

XT Bronze Stair Edgings



BXT20
shown with Polished Bronze
channel and insert

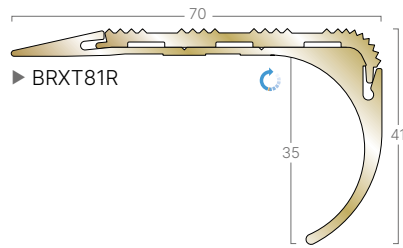
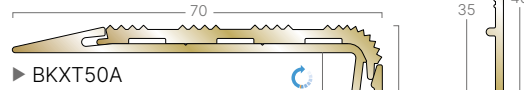
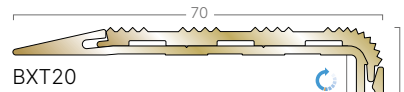

BIM Available to download as BIM objects.
Visit www.gradus.com

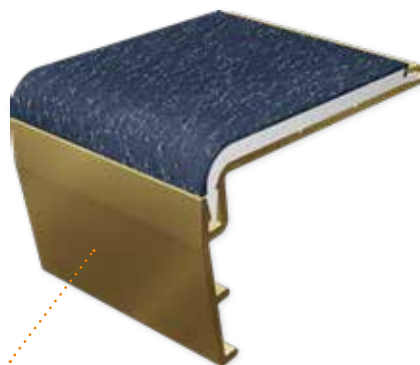
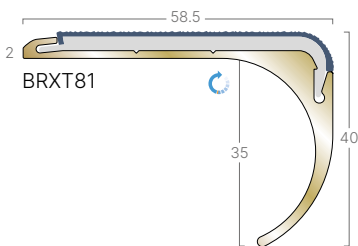
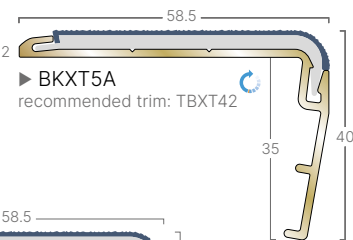
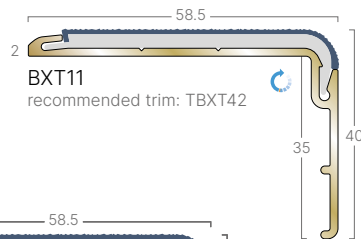
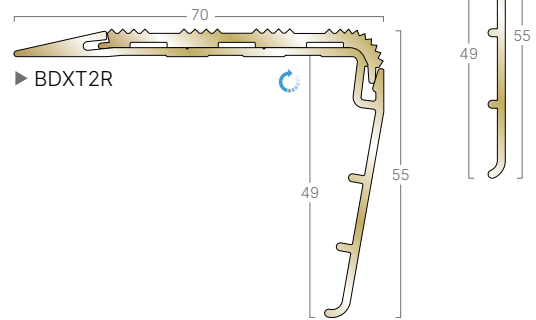
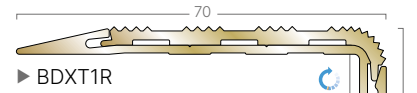

BKXT5A
shown with Polished Bronze channel
and Xtra-grip Neptune insert



Curving option available in original XT
subject to approval of template

Visit: www.gradus.com
for full details



Dimensions shown are nominal
Illustrations are 70% size in mm

► New - Stock available
January 2024









Channel options:

Insert options:

















Metal finishes:

- Polished Bronze 
- Satin Bronze 





















Metal Castellated:

- Polished Bronze 
- Satin Bronze 
- Aluminium 
- Brushed Stainless Steel 
- Polished Chrome 
- Satin Chrome 
- Antique Brass 
- Antique Bronze 
- Black Anodised 

Xtra-grip:

- Onyx 
- Neptune 
- ▶ Baltic 
- ▶ Aegean 
- ▶ Forest 
- Graphite 
- Quarry 
- Concrete 
- Surf 
- Bamboo 
- ▶ Claret 
- ▶ Chestnut 
- Umber 
- ▶ Sepia 
- ▶ Tuscan 
- Pumice 
- Ochre 
- Frost 

Interior Standard Finish:

- Jet 
- Ink 
- ▶ Ocean 
- ▶ Teal 
- ▶ Evergreen 
- Lead 
- Steel 
- Glacier 
- Wisp 
- Sky 
- Clay 
- Jade 
- Burgundy 
- ▶ Spice 
- Coffee 
- ▶ Bronze 
- ▶ Linen 
- Canvas 
- Buttercup 
- Snowdrift 

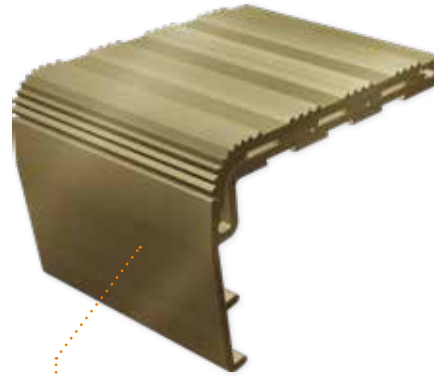
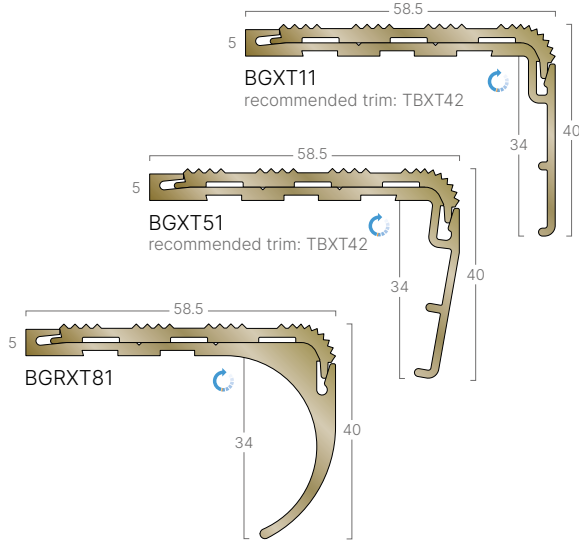

BGXT51 shown with Satin Bronze channel and insert



BGRXT121 shown with Satin Bronze channel and Interior Burgundy insert

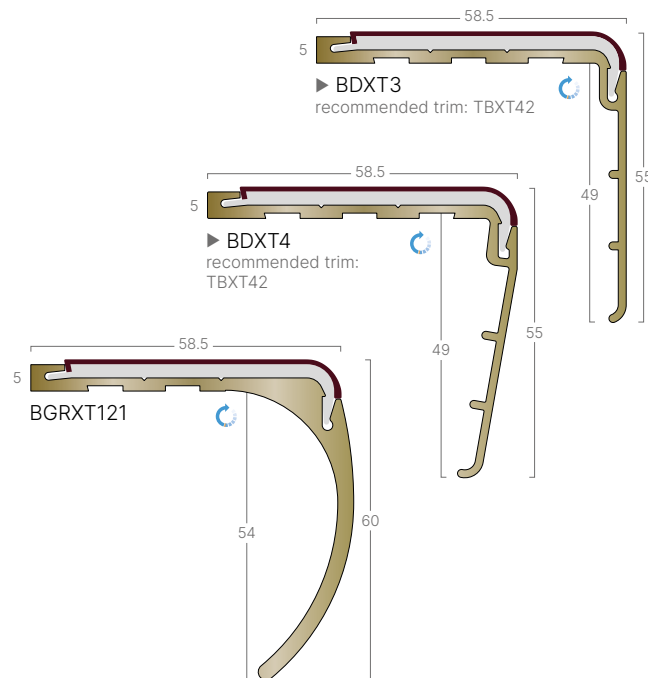

Gauge	Ramp - typically used with resilient flooring or where no surface floorcoverings are used 2mm - typically used with resilient flooring 5mm - typically used with carpet or resilient flooring with bevelled underlay
Trims	For recommended trims see individual profiles.
Colour	For larger colour swatches see page 7 Light Reflectance Values (LRVs) and NCS references see page 17
Samples	For an accurate profile finish or insert colour reference, request a free sample today by calling Gradus Technical Support on 01625 428922

XT Aluminium Stair Edgings

When it comes to safety and performance our XT Aluminium stair edgings offer the ultimate solution, but this doesn't mean that design flexibility within projects needs to be compromised. We have now taken our XT Aluminium range to the next level with the introduction of several new premium profile finishes, a new metal castellated insert available in corresponding finishes, plus we've added a selection of new

colours to our XT Standard Interior finish & Xtra-grip insert offering, which will appeal to luxury hospitality and high-end residential projects.

These additional options are available across all 26 of our existing XT Aluminium profiles.



Channel and insert options

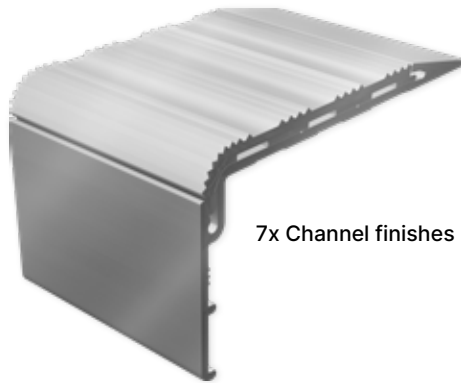

7x Channel finishes

3x Insert options



Interior Standard Finish

Conditions: Interior Dry
Material: Pvc with mineral inclusion

Areas where there is no risk that the stairs will be contaminated by moisture.



Xtra-grip

Conditions: Interior Dry / Interior Wet
Material: Pvc with mineral aggregate

Increased surface roughness where the stair edging may become wet e.g. stairs close to entrances.

NEW

Aluminium channel finishes

XT Aluminium is now offered with an enhanced choice of attractive contemporary finishes, including our new Antique Brass and Antique Bronze effects.

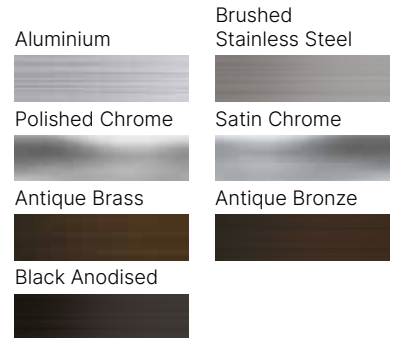

NEW

Metal Castellated

Conditions: Interior Dry / Interior Wet
Material: Aluminium or bronze

Provides an all-metal solution that features a castellated design.



Aluminium:

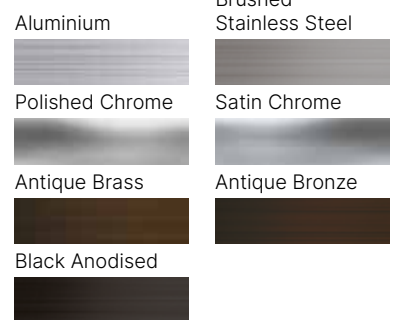

Bronze:



▶ New - Stock available January 2024

For Light Reflectance Values (LRVs) and NCS references see page 17.

Finishes depicted are representative only and are subject to print interpretation.

For accurate referencing, request a free sample by calling Gradus Technical Support on 01625 428922.

XT Aluminium Stair Edgings

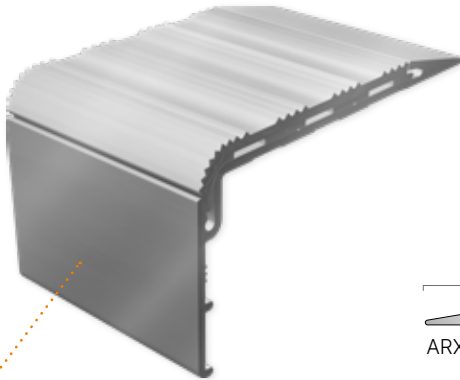

ASXT20
shown with Aluminium
channel and insert

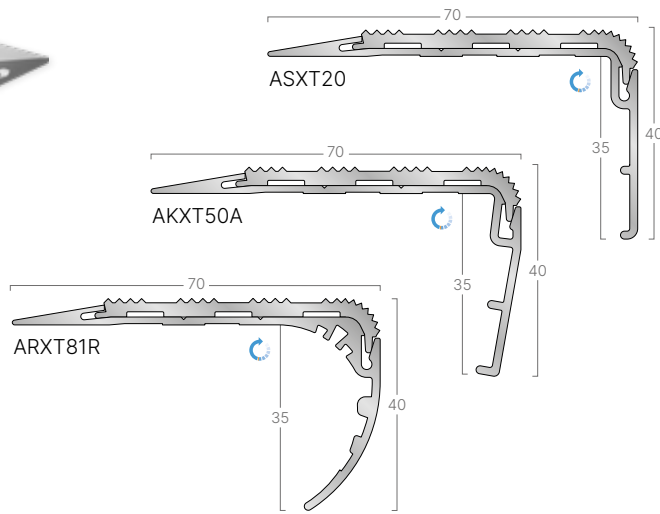

BIM Available to download as BIM objects.
Visit www.gradus.com

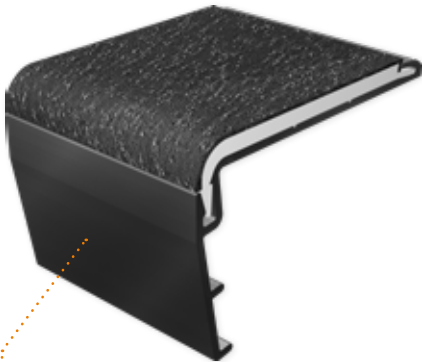

AKXT5A
shown with Black Anodised channel
and Xtra-grip Onyx insert

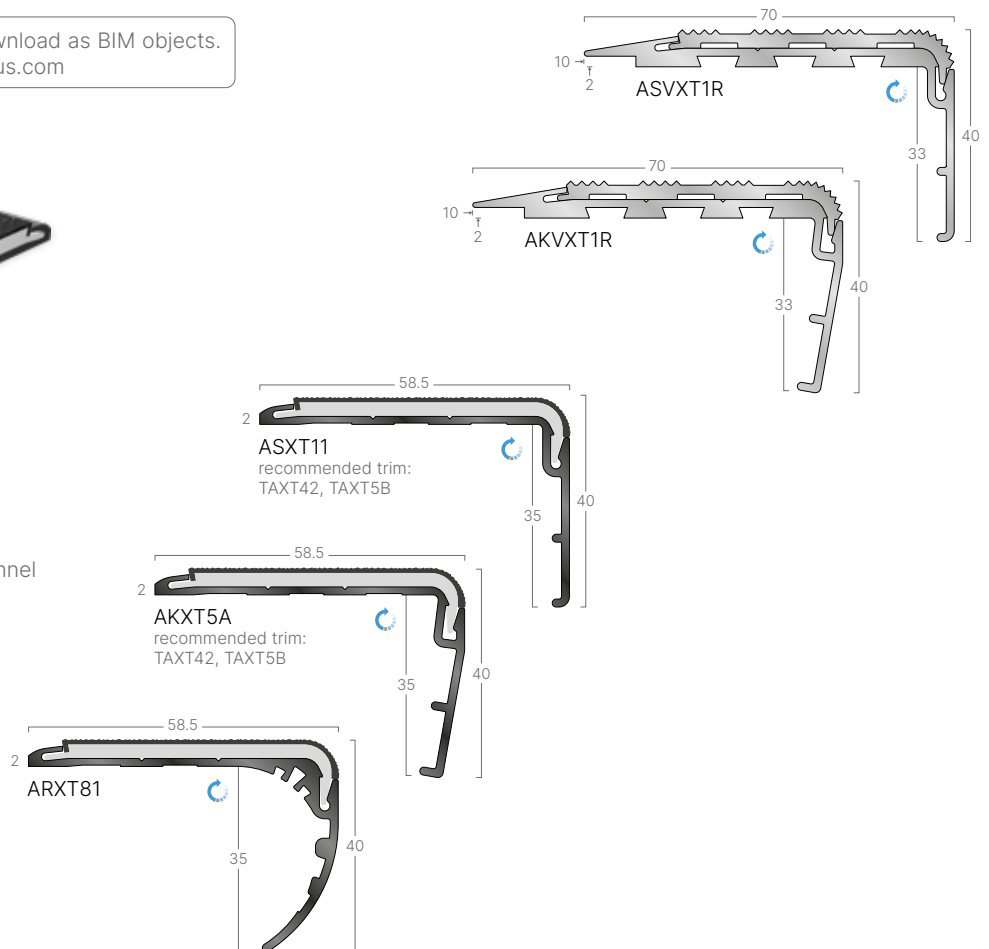

Curving option available in original XT
subject to approval of template

Visit: www.gradus.com
for full details

Dimensions shown are nominal
Illustrations are 70% size in mm

► New - Stock available
January 2024

Channel options:

Insert options:

Metal finishes:

- Aluminium
- Brushed Stainless Steel
- Polished Chrome
- Satin Chrome
- Antique Brass
- Antique Bronze
- Black Anodised

Metal Castellated:

- Aluminium
- Brushed Stainless Steel
- Polished Chrome
- Satin Chrome
- Antique Brass
- Antique Bronze
- Black Anodised
- Polished Bronze
- Satin Bronze

Xtra-grip:

- Onyx
- Neptune
- ▶ Baltic
- ▶ Aegean
- ▶ Forest
- Graphite
- Concrete
- Surf
- Bamboo
- ▶ Claret
- ▶ Chestnut
- Umber
- ▶ Sepia
- ▶ Tuscan
- Pumice
- Ochre
- Frost

Interior Standard Finish:

- Jet
- Ink
- ▶ Ocean
- ▶ Teal
- ▶ Evergreen
- Lead
- Steel
- Glacier
- Wisp
- Sky
- Clay
- Jade
- Burgundy
- ▶ Spice
- Coffee
- ▶ Bronze
- ▶ Linen
- Canvas
- Buttercup
- Snowdrift



ADXT2R
shown with Polished Chrome
channel and Interior
Steel insert

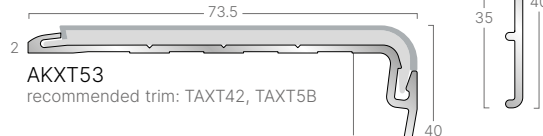
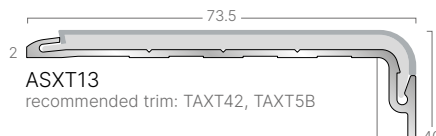
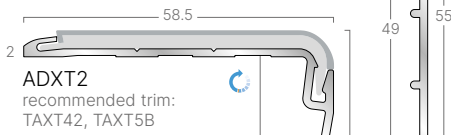
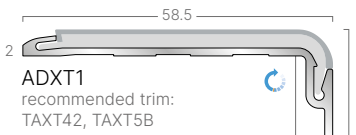
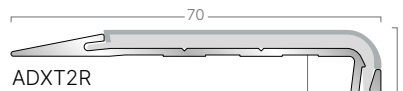
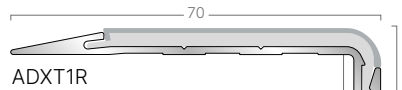
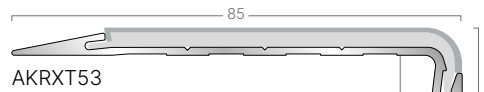
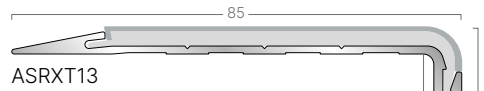

Gauge	Ramp - typically used with resilient flooring or where no surface floorcoverings are used Notched Ramp - Designed to overlay 2mm vinyl 2mm - typically used with resilient flooring
Trims	For recommended trims see individual profiles.
Colour	For larger colour swatches see page 11 Light Reflectance Values (LRVs) and NCS references see page 17
Samples	For an accurate profile finish or insert colour reference, request a free sample today by calling Gradus Technical Support on 01625 428922

XT Aluminium Stair Edgings

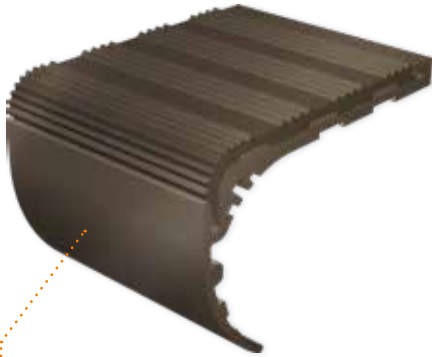

GRXT81
shown with Antique Brass
channel and insert

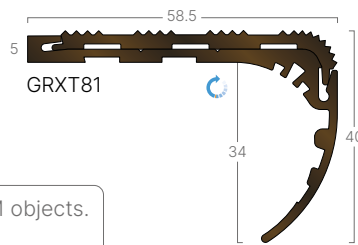
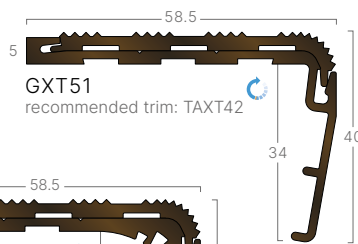
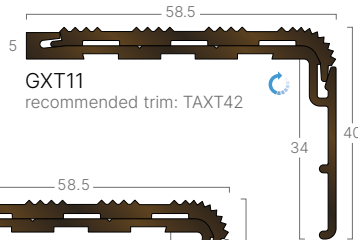

BIM Available to download as BIM objects.
Visit www.gradus.com

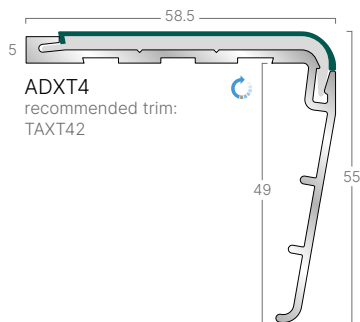
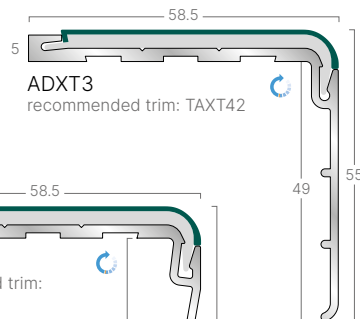

ADXT3
shown with Satin Chrome channel
and Interior Evergreen insert



XT PVC-u Hardnose range also available.
Visit www.gradus.com



Curving option available in original XT
subject to approval of template

Visit: www.gradus.com
for full details

Dimensions shown are nominal
Illustrations are 70% size in mm

► New - Stock available
January 2024

Channel options:

Insert options:

Metal finishes:

- Aluminium
- Brushed Stainless Steel
- Polished Chrome
- Satin Chrome
- Antique Brass
- Antique Bronze
- Black Anodised

Metal Castellated:

- Aluminium
- Brushed Stainless Steel
- Polished Chrome
- Satin Chrome
- Antique Brass
- Antique Bronze
- Black Anodised
- Polished Bronze
- Satin Bronze

Xtra-grip:

- Onyx
- Neptune
- ▶ Baltic
- ▶ Aegean
- ▶ Forest
- Graphite
- Quarry
- Concrete
- Surf
- Bamboo
- ▶ Claret
- ▶ Chestnut
- Umber
- ▶ Sepia
- ▶ Tuscan
- Pumice
- Ochre
- Frost

Interior Standard Finish:

- Jet
- Ink
- ▶ Ocean
- ▶ Teal
- ▶ Evergreen
- Lead
- Steel
- Glacier
- Wisp
- Sky
- Clay
- Jade
- Burgundy
- ▶ Spice
- Coffee
- ▶ Bronze
- ▶ Linen
- Canvas
- Buttercup
- Snowdrift



GXT53 shown with Brushed Stainless Steel channel and Xtra-grip Quarry insert

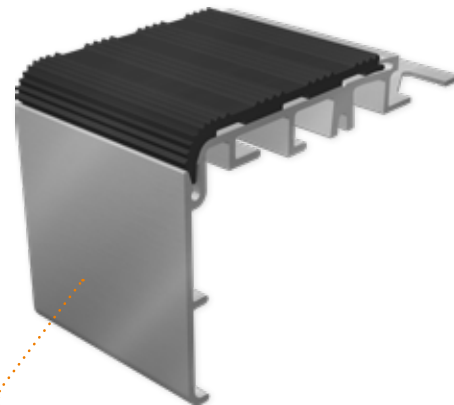
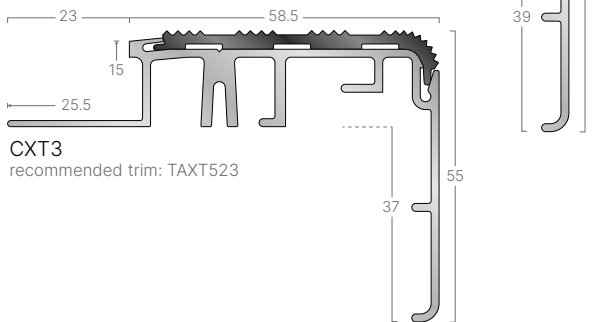
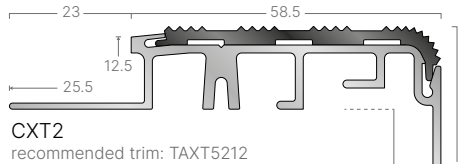
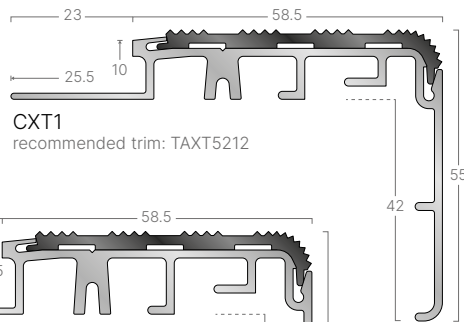
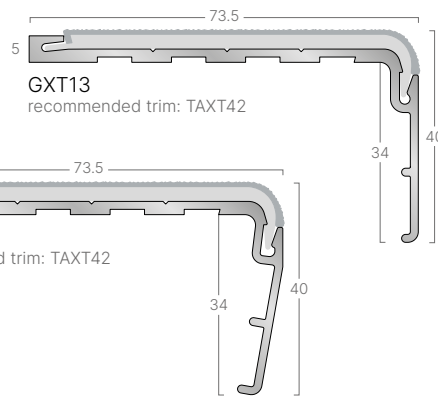

CXT1 shown with Aluminium channel and Black Anodised insert

Gauge	5mm - typically used with carpet or resilient flooring with bevelled underlay 10mm - 15mm - typically used with ceramics, stone and marble.
Trims	For recommended trims see individual profiles.
Colour	For larger colour swatches see page 11 Light Reflectance Values (LRVs) and NCS references see page 17
Samples	For an accurate profile finish or insert colour reference, request a free sample today by calling Gradus Technical Support on 01625 428922

Associated Products for Stairs & Floors

Welded Corners with TC1 Clips

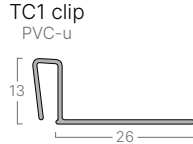
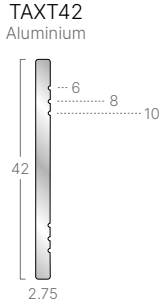
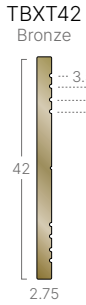

Welded Corner with Fixed Flange

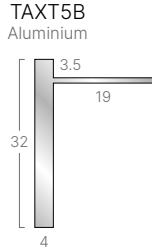

Bronze trim finishes:

- Satin Bronze
- Polished Bronze

Aluminium trim finishes:

- Aluminium
- Brushed Stainless Steel
- Polished Chrome
- Satin Chrome
- Antique Brass
- Antique Bronze
- Black Anodised

Welded Corners with TC3 Clips

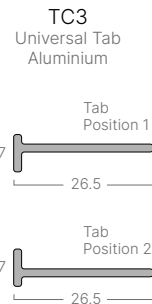
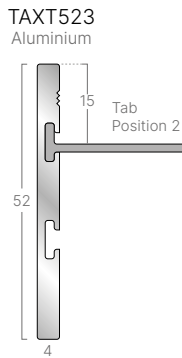
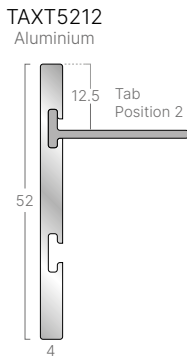
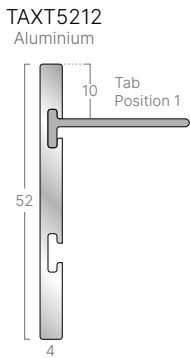

Nap Trims

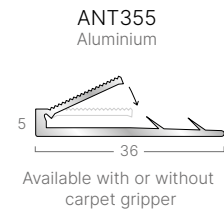

Gradus Grip GG290 - Stair Edging Adhesive

A secure bond between the stair edging and the step is essential to ensuring a safe installation.

Gradus Grip is a solvent free rapid curing flexible adhesive with excellent gap filling properties that is suitable for bonding stair edgings to most solid surfaces.

Why choose Gradus Grip:

- > **Saves time & money** - quick and easy installation
- > **10 year warranty** - on both the Gradus stair edging and Gradus Grip
- > **No more screw head cover plugs** - improved aesthetic and easier to maintain
- > **Ultra strong bond** - complete peace of mind



The stair edging, insert format, type and condition of the substrate and the application will affect the installation method required. Installation instructions are available to download at www.gradus.com.



FREE Measuring Service

Eliminate risk by arranging for a **FREE*** and accurate stair edging measure with Gradus

- > Save time
- > Save money
- > Reduces Waste
- > Avoids Errors

For further details or to **book a measure**, call Gradus Technical Support on 01625 428922.

*UK mainland only.



Fabrication Service

Curved Stair Edgings

- > Fastest, most reliable fabrication service in the UK
- > Ready for despatch within 5 working days*

Welded Corners

- > 83° and 90° welded corners are available in matching finishes

*Terms & Conditions apply - see www.gradus.com



Light Reflectance Values (LRVs) and NCS References

Metal Castellated			
Colour Reference	LRV	NCS	
	74.21	4005-B80G	
	48.85	6020-G70Y	
	50.73	S7502-G	
	58.17	S9000-N	
	4.35	8500N	
	9.78	7005-Y20R	
	7.55	8005-R20B	
	66.86	4050-G40Y	
	59.60	2040-R20B	

Project Rainbow and ADM recommend that there is at least a 30 point difference between the LRVs of the stair nosing and floorcovering to achieve a suitable contrast.

For further details contact Gradus Technical Support on 01625 428922.

Xtra-grip			
Colour Reference	LRV	NCS	
	4.52	8502-B	
	5.03	8010-R70B	
	8.00	6020-R90B	
	7.02	6530-B30G	
	6.69	7020-B70G	
	12.56	6502-B	
	24.71	4500-N	
	37.44	2502-B	
	43.58	1515-R90B	
	45.84	2005-B80G	
	5.70	6030-R10B	
	15.36	4050-Y70R	
	5.71	8005-Y50R	
	27.71	5020-Y20R	
	34.86	3010-Y40R	
	46.83	2005-Y30R	
	49.97	1060-Y	
	66.51	1002-G50Y	

Interior Standard Finish			
Colour Reference	LRV	NCS	
	4.56	8502-B	
	4.96	8010-R70B	
	8.00	6020-R90B	
	7.02	6530-B30G	
	6.69	7020-B70G	
	12.77	7005-R50B	
	26.99	4500-N	
	42.09	2502-B	
	58.17	2000-N	
	52.63	1515-R90B	
	47.97	2502-Y	
	53.98	2005-G	
	5.70	6030-R10B	
	15.36	4050-Y70R	
	6.05	8010-Y50R	
	27.71	5020-Y20R	
	38.59	3010-Y30R	
	53.27	2005-Y30R	
	55.54	1070-Y	
	83.77	0500-N	

A Fusion of Products

Gerflor and Gradus offer products which are ideal for use in a wide variety of applications including hospitality & leisure, residential developments, retail and commercial office.



LED Architectural Lighting



Luxury Vinyl Tiles & Planks (LVT)



Barrier Matting Systems



GRADUS

Gradus Ltd Park Green Macclesfield Cheshire SK11 7LZ

For enquiries outside the UK and Eire contact Gradus International on +44 (0)1625 613780

Gradus International
England

Tel +44 (0) 1625 613780

Gradus Far East
Singapore

Tel: (+65) 6734 5933

call: 01625 428922
gradus.com