

## Concrete Waterproofing Systems Integral Protection

- Unique self-repairing chemical admix for waterproofing and protection of concrete
- Approved as Type B Integral Protection in accordance with BS 8102 (2009)
- Compatible with a wide range of cements and cement replacement materials
- For new build basements, underground car parks, swimming pools etc
- Can be used in conjunction with Type A and Type C systems to form a combined solution
- Accepted by NHBC, Premier Guarantee, LABC Warranty etc

# TRITON



## About Triton Systems

The company holds British Board of Agrément approvals and is a BS EN ISO 9001 Quality Assured Company. Triton was represented on the technical committee responsible for drafting British Standard BS 8102 (2009) – the Code of Practice for protection of below ground structures against water from the ground – and supplies systems and products to meet the requirements of all three methods of waterproofing as defined by the Standard.

To support architects, surveyors and contractors, a full programme of training courses has been created including RIBA approved CPD seminars on basement waterproofing and green/living roofs. More details can be found at [tritonsystems.co.uk](http://tritonsystems.co.uk)

## Concrete Waterproofing Systems – Integral Protection

The products described in this brochure are designed to be used in the construction of watertight concrete structures, typically new build and retrofit basements, underground car parks, swimming pools and lift pits. The range includes a unique chemical admix, systems for sealing construction joints and cable ducts, and products to make repairs. Triton also offers full system back up, including liaison with the concrete batching plant, mix design, construction joint detailing, site monitoring, repairs and warranty (where required).

### Barrier Waterproofing

Triton also provides a range of products to achieve waterproofing that conforms to BS 8102 (2009) Type A – Barrier Protection.

### Cavity Drain Systems

Triton supplies a range of cavity drain membranes to achieve waterproofing that conforms to BS 8102 (2009) Type C. Please refer to the separate 'Cavity Drain Systems' brochure.

### Ground Gas Barriers

Triton supplies systems for protection against Radon, Methane and Carbon Dioxide. A range of liquid applied and sheet membranes is available plus fans, pumps, sumps and ancillary products.



Available for download at [tritonsystems.co.uk](http://tritonsystems.co.uk):  
Material Safety Data Sheets for all Triton products  
A comprehensive library of technical drawings

## TRITON TT ADMIX

- Withstands extreme hydrostatic pressure (up to 12 bar)
- Increases durability
- Reduces shrinkage and cracking
- Protects concrete and steel from aggressive chemicals such as chlorides
- 10 year warranty available\*

A unique chemical treatment for the waterproofing and protection of concrete, which is added to concrete at time of batching. The active chemicals in the TT Admix react with fresh concrete to generate insoluble crystalline growths, which seal the concrete against water penetration and protect the concrete against harsh environmental conditions. Packed as a dry powder compound, TT Admix consists of Portland cement, very fine treated silica sand and various active proprietary chemicals. The functional, active components of the TT Admix remain available within the cured concrete and are reactivated should minor cracking or movement occur when water is present.

### Specification:

In accordance with NBS Specification J10 Cementitious Mortar Tanking/Damp Proofing, Type B Integral Protection in accordance with BS 8102 (2009)

### Technical Data:

TT Admix is added to concrete at time of batching in dry powder form at a rate of 1.17% by weight of cement.

The concrete mix requirements for optimum performance of TT Admix requires a minimum cement content of 350kgs/m<sup>3</sup>.

The product is compatible with cement blends containing pulverised-fuel ash, ground granulated blast furnace slag and silica fume blends as defined in BS EN 197-1 : 2011. The maximum water : cement ratio is 0.45.

\* Warranty available on request subject to TT Admix monitoring scheme

\*\* PFA – Pulverised Fuel Ash Cement Replacement

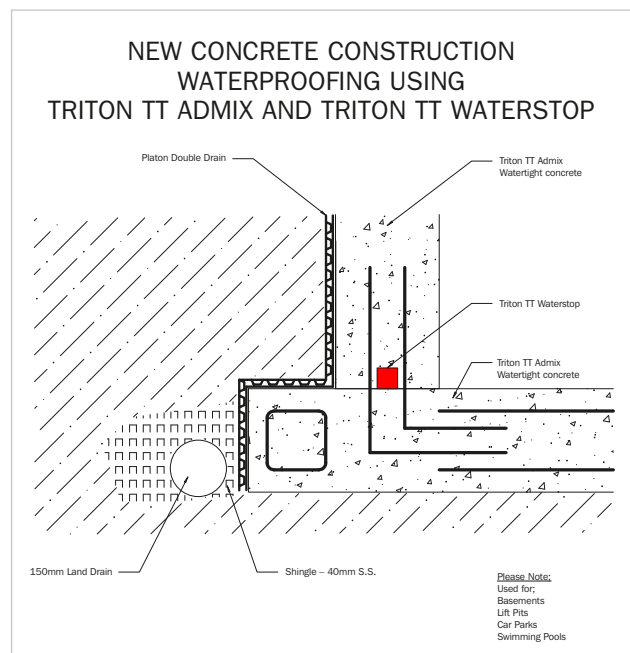

## TRITON TT WATERSTOP

- BDA Certified
- Designed to seal poured in-situ construction joints
- Swells up to 270% when in contact with water
- Will withstand up to 60m head of water pressure
- Permanent water tight function

The use of Triton TT Waterstop and Triton TT Swellmastic S2 is a critical part of the TT Admix Watertight Concrete System. Triton TT Waterstop is supplied as a 20mm x 25mm pre-formed waterstop in a ready to use roll. It has a built in delay system and the product activates after 2 days of exposure to water. Once activated, it will withstand up to 60m head of water pressure.

When fully encapsulated by poured concrete, the expansive forces form a seal against concrete surfaces. The seal resists hydrostatic pressure, stopping water from entering the sub-structures. Triton TT Waterstop will return to its original size if the concrete and substrate is completely dry and re-expand if water or moisture is introduced again to the joints.

### Specification:

In accordance with NBS specification E40 310 Designed joints in-situ concrete.

### Technical Data:

Expansion properties	Values
Edometric Swelling Index (%)	>160
Expansion due to contact with water (4 days)	270%
Swelling Pressure (kPa)	>300
Permeability	No flow

**NB** Installation guidelines for Triton TT Waterstop and Triton TT Swellmastic S2 can be downloaded at [tritonsystems.co.uk](http://tritonsystems.co.uk)



1. Chase Cast in centre of wall section/joint section. Approximately 20mm x 15mm

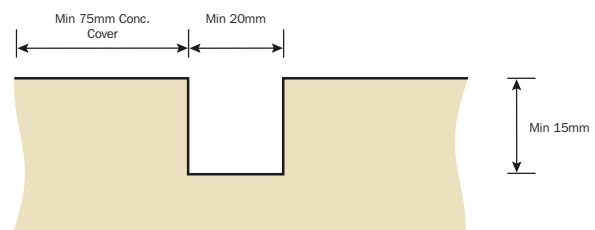

2. Min 10mm Bead Triton TT Swellmastic S2 to base of chase

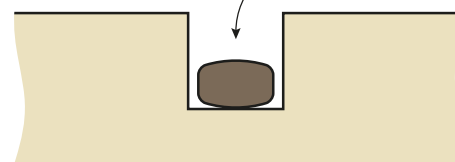

3. TT Waterstop adhered to chase of Triton TT Swellmastic S2

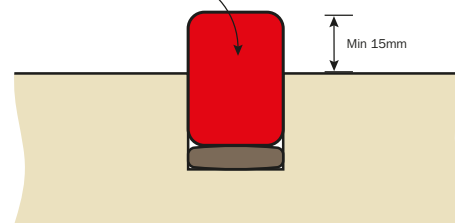

4. Joint option for TT Waterstop (within chase)

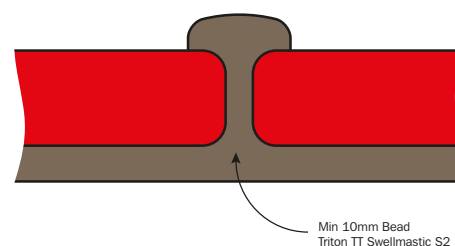

## TRITON TT SWELLMASTIC S2

- Good adhesion to various substrates
- Optimised expansion rate, therefore no damage to fresh concrete during curing
- Swells in contact with water
- Permanently water resistant
- Adaptable to fit many different detail tasks

Triton TT Swellmastic S2 is a one part, ready to use hydro-reactive expansion mastic for the sealing of construction joints and around pipe penetrations. In contact with water Swell Mastic expands to around 350% of its original volume.

### Specification:

In accordance with NBS Specification E40 530 Designed joints in-situ concrete.

### Technical Data:

Property	Value
Chemical Base	1-part polyurethane, moisture curing
Density	1.33 kg/l (+ 23°C)
Skinning Time	2 hours (+ 23°C / 50% r.h.)
Curing Rate	After 1 day: ~2.0mm (+23°C / 50% r.h.) After 10 days: ~10.0mm (+23°C / 50% r.h.)
Sag Flow	< 2mm
Change of Volume	1 day in tap water: < 25% 7 days in tap water: < 100% Swelling properties in salty water will be reduced and delayed
Shore A Hardness	Swollen (7 days in tap water): > 10 Non-swollen (7 days: +23°C / 50% r.h.): 40-60

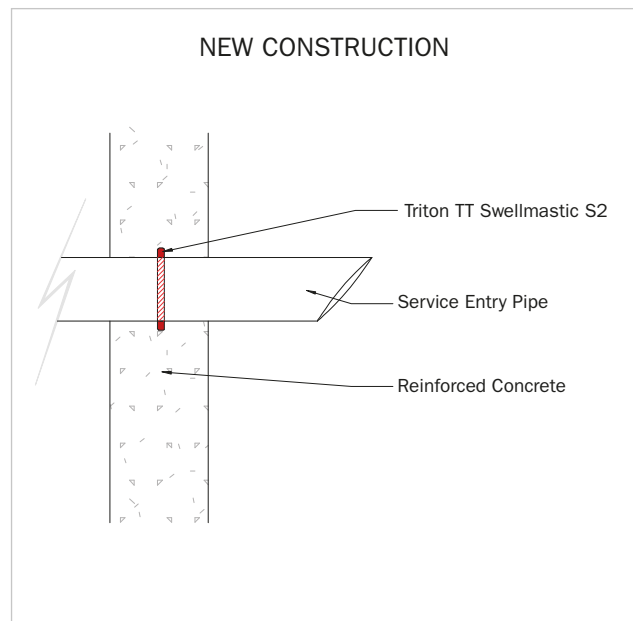

**NB** Installation guidelines for Triton TT Waterstop and Triton TT Swellmastic S2 can be downloaded at [tritonsystems.co.uk](http://tritonsystems.co.uk)

## TRITON INJECTION TUBE

- Simple installation
- Can be injected with all known resins
- Repeated injection possible

Triton Injection Tube is designed for waterproofing construction joints in new and existing structures and specifically for the multiple injection of suitable grouts into construction joints and other areas that may require injection at a later date. The tube can be placed in lengths of 10 – 30 metres.







The tube is placed between the reinforcement bars or along the interface joints of concrete slabs and is held in place using special clips to ensure it remains in place even during concrete pouring. Injection points are normally placed through the formwork to provide easy access when injection is required.

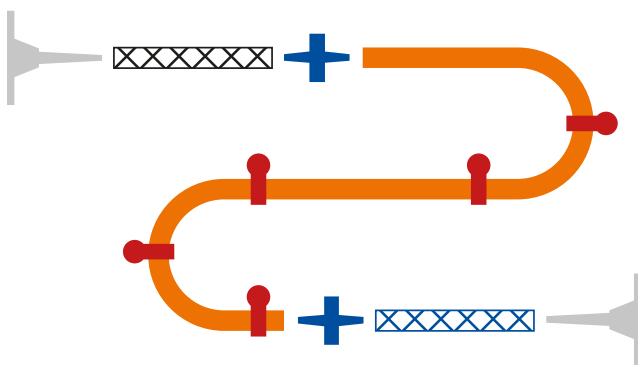

### Technical Data:

Colour	Orange
Size	Internal 5-6mm External 12mm
Construction	Virgin PVC
Slot length	4mm
Toxicity	Non-Toxic



	Shutter Connector
	Hose Connector
	Hose Fixing Bracket
	Inlet Hose
	Outlet Hose
	Injection Hose

## REPAIRS USING TRITON TT SUPER, TRITON FILLET SEAL AND TRITON QUICK SET

Following the placement, curing and compaction of Triton TT Admix watertight concrete, upon removal of the formwork and exposing of the placed concrete, a visual inspection is required. If honeycombing or leaks to the construction joints are identified then repairs can be made using Triton TT Super (barrier waterproofing system), Triton Fillet Seal and Triton Quick Set plugging compound.



Construction joint repair using Triton Fillet Seal.

## SEALING CABLE DUCTS USING TRITON QUICK SET, TRITON 190 RESIN AND TRITON TT55

Triton offers a complete system of products for sealing cable ducts in below ground structures and/or areas prone to flooding.

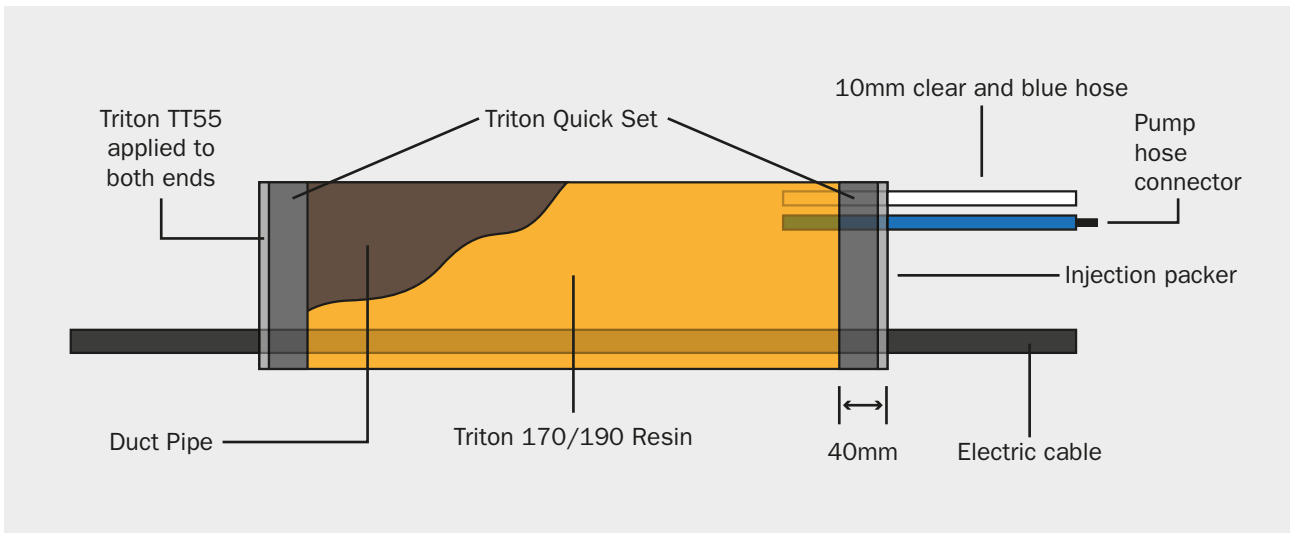



**Basement  
Waterproofing**  
ASSOCIATION



Triton Systems supplies high performance cavity drain, watertight concrete, cementitious and liquid applied and fully bonded waterproofing systems designed to meet BS 8102 (2009). These are complemented by flooring, roofing and gas barrier systems and traditional timber preservation and damp proofing products.

Available for download at [tritonsystems.co.uk](http://tritonsystems.co.uk):

- Booking forms for training courses and RIBA approved CPD seminars
- Technical and Material Safety Data Sheets for all Triton products
- Detail drawings for all Triton products
- Installation guides
- Product literature
- BBA/BDA and CE Marking Certificates
- Case studies



**Triton Systems**

Units 3 – 5 Crayford Commercial Centre, Greyhound Way, Crayford, Kent DA1 4HF  
Tel: 01322 318830 Fax: 01322 524017 Email: [info@tritonsystems.co.uk](mailto:info@tritonsystems.co.uk)

Triton Chemical Manufacturing Co Ltd trading as Triton Systems